



RC KPS

Multi-zone Wall Mount Remote Controls

CONTENTS

- CONTENTS 3
- SAFETY PRECAUTIONS AND GENERAL INFORMATION 5
- DESCRIPTION 8
- CONNECTION..... 9
- MOUNTING 10
- OPERATION..... 11
- SETUP 12
- CONFIGURATION 17
- DIMENSIONS 28
- SPECIFICATIONS..... 29



ATTENTION

CAUTION

RISK OF ELECTRIC SHOCK
DO NOT OPEN



CAUTION

WARNING: SHOCK HAZARD – DO NOT OPEN

ATTENTION: RISQUE D'ÉLECTROCUTION - NE PAS OUVRIR

WARNING: TO REDUCE THE RISK OF FIRE OR ELECTRIC SHOCK DO NOT EXPOSE
THIS EQUIPMENT TO RAIN OR MOISTURE

ATTENTION: NE PAS EXPOSER CE MATÉRIEL À LA PLUIE OU L'HUMIDITE AFIN DE
REDUIRE LE RISQUE D'INFLAMMATION OU DE CHOC ÉLECTRIQUE







PROTECTING EARTHING TERMINAL. THE APPARATUS SHOULD BE
CONNECTED TO A MAINS SOCKET WITH A PROTECTIVE EARTH
CONNECTION.

RCF S.p.A. thanks you for purchasing this product, which has been designed to guarantee reliability and high performance.

SAFETY PRECAUTIONS AND GENERAL INFORMATION

Symbols used in this document give notice of important operating instructions and warnings which must be strictly followed.

	CAUTION	Important operating instructions explains hazards that could damage a product, including data loss
	WARNING	Important advice concerning the use of dangerous voltages and the potential risk of electric shock, personal injury or death.
	IMPORTANT NOTES	Helpful and relevant information about the topic
	SUPPORTS, TROLLEYS AND CARTS	Information about the use of supports, trolleys and carts. Reminds to move with extreme caution and never tilt.
	WASTE DISPOSAL	This symbol indicates that this product should not be disposed with your household waste, according to the WEEE directive (2012/19/EU) and your national law.



IMPORTANT NOTES

This manual contains important information about the correct and safe use of the device. Before connecting and using this product, please read this instruction manual carefully and keep it on hand for future reference. The manual is to be considered an integral part of this product and must accompany it when it changes ownership as a reference for correct installation and use as well as for the safety precautions. RCF S.p.A. will not assume any responsibility for the incorrect installation and / or use of this product.

SAFETY PRECAUTIONS

1. All the precautions, in particular the safety ones, must be read with special attention, as they provide important information.
2. This is a professional product. Its use is reserved to instructed persons, in relation to the connected risks.
3. Power supply from mains:
 - a. The mains voltage is sufficiently high to involve a risk of electrocution; install and connect this product before plugging it in.
 - b. Before powering up, make sure that all the connections have been made correctly and the voltage of your mains corresponds to the voltage shown on the rating plate on the unit, if not, please contact your RCF dealer.
 - c. The metallic parts of the unit are earthed through the power cable. An apparatus with CLASS I construction shall be connected to a mains socket outlet with a protective earthing connection.
 - d. Protect the power cable from damage; make sure it is positioned in a way that it cannot be stepped on or crushed by objects.
 - e. To prevent the risk of electric shock, never open this product: there are no parts inside that the user needs to access.
 - f. Be careful: in the case of a product supplied by manufacturer only with POWERCON connectors and without a power cord, all power cords and plug assemblies shall be in compliance with the requirements of the IEC 62368-1 and certified and suitable for use in the particular countries where the product shall be installed.
4. Make sure that no objects or liquids can get into this product, as this may cause a short circuit. This apparatus shall not be exposed to dripping or splashing. No objects filled with liquid, such as vases, shall be placed on this apparatus. No naked sources (such as lighted candles) should be placed on this apparatus.
5. Never attempt to carry out any operations, modifications or repairs that are not expressly described in this manual. Contact your authorized service centre or qualified personnel should any of the following occur:

- The product does not function (or functions in an anomalous way).
 - The power cable has been damaged.
 - Objects or liquids have got in the unit.
 - The product has been subject to a heavy impact.
6. This product does not contain user replaceable fuses. Fuses replacement is a service operation and must be performed by qualified personnel.
 7. If this product is not used for a long period, disconnect the power cable.
 8. If this product begins emitting any strange odours or smoke, switch it off immediately and disconnect the power cable.
 9. Do not connect this product to any equipment or accessories not foreseen. For suspended installation, only use the dedicated anchoring points and do not try to hang this product by using elements that are unsuitable or not specific for this purpose. Also check the suitability of the support surface to which the product is anchored (wall, ceiling, structure, etc.), and the components used for attachment (screw anchors, screws, brackets not supplied by RCF etc.), which must guarantee the security of the system / installation over time, also considering, for example, the mechanical vibrations normally generated by transducers. To prevent the risk of falling equipment, do not stack multiple units of this product unless this possibility is specified in the user manual.
 10. **RCF S.p.A. strongly recommends this product is only installed by professional qualified installers (or specialised firms) who can ensure correct installation and certify it according to the regulations in force. The entire audio system must comply with the current standards and regulations regarding electrical systems.**
 11. Supports, trolleys and carts.



The equipment should be only used on supports, trolleys and carts, where necessary, that are recommended by the manufacturer. The equipment / support / trolley / cart assembly must be moved with extreme caution. Sudden stops, excessive pushing force and uneven floors may cause the assembly to overturn. Never tilt the assembly.

12. There are numerous mechanical and electrical factors to be considered when installing a professional audio system (in addition to those which are strictly acoustic, such as sound pressure, angles of coverage, frequency response, etc.).
13. Hearing loss. Exposure to high sound levels can cause permanent hearing loss. The acoustic pressure level that leads to hearing loss is different from person to person and depends on the duration of exposure. To prevent potentially dangerous exposure to high levels of acoustic pressure, anyone who is exposed to these levels should use adequate protection devices. When a transducer capable of producing high sound levels is being used, it is therefore necessary to wear ear plugs or protective earphones. See the manual technical specifications to know the maximum sound pressure level.

OPERATING PRECAUTIONS

- Place this product far from any heat sources and always ensure an adequate air circulation around it.
- Do not overload this product for a long time.
- Never force the control elements (keys, knobs, etc.).
- Do not use solvents, alcohol, benzene or other volatile substances for cleaning the external parts of this product.



IMPORTANT NOTES

To prevent the occurrence of noise on line signal cables, use screened cables only and avoid putting them close to:

- **Equipment that produces high-intensity electromagnetic fields**
- **Power cables**
- **Loudspeaker lines**



WARNING! CAUTION! To prevent the risk of fire or electric shock, never expose this product to rain or humidity.



WARNING! to reduce the risk of electric shock, do not disassemble this product unless you are qualified. Refer servicing to qualified service personnel.

CORRECT DISPOSAL OF THIS PRODUCT



This product should be handed over to an authorized collection site for recycling waste electrical and electronic equipment (EEE). Improper handling of this type of waste could have a possible negative impact on the environment and human health due to potentially hazardous substances that are generally associated with EEE. At the same time, your cooperation in the correct disposal of this product will contribute to the effective usage of natural resources. For more information about where you can drop off your waste equipment for recycling, please contact your local city office, waste authority or your household waste disposal service.

CARE AND MAINTENANCE

To ensure a long-life service, this product should be used following these advices:

- If the product is intended to be set up outdoors, be sure it is under cover and protected to rain and moisture.
- Always use a dry cloth to clean the exterior surfaces of the speaker and always do it when the power is turned off.



CAUTION: to avoid damaging the exterior finishes do not use cleaning solvents or abrasives.

FCC NOTES

This equipment has been tested and found to comply with the limits for a Class A digital device, pursuant to Part 15 of the FCC Rules. These limits are designed to provide reasonable protection against harmful interference when the equipment is operated in a commercial environment. This equipment generates, uses, and can radiate radio frequency energy, and if it is not installed and used in accordance with the instruction manual, it may cause harmful interference to radio communications. Operation of this equipment in a residential area is likely to cause harmful interference, in which case the user will be required to correct the interference at his own expense.

Modifications: Any modifications made to this device that are not approved by RCF may void the authority granted to the user by the FCC to operate this equipment.

RCF S.p.A. reserves the right to make changes without prior notice to rectify any errors and / or omissions. Always refer to the latest version of the manual on www.rcf.it.

DESCRIPTION



RC KPS is a wall-mounted device designed for the remote control of volume level and input source selection, of any KPS SERIES amplifier.

Each remote control can manage one single zone or multiple zones configured within RDSpace. If the user has configured it with:

- one single zone, the device behaves as a single-zone controller.
- more than one zone, the device behaves as a multi-zone controller.

Multiple RC KPS devices can be assigned to the same zone, although it is not recommended to connect more than 8 devices to a single KPS amplifier.

RC KPS devices are only compatible with KPS SERIES amplifiers running firmware version 1.3.0 or later. This manual refers to firmware version 1.4.

Ensure to update the firmware installed on the KPS amplifier before proceeding to install and configure RC KPS devices. The latest firmware version is always available on RCF website www.rcf.it.



RC KPS is not self-powered. Power is supplied to the device with the use of a standard PoE Switch (or PoE injector) and Cat5 cable (or above).

CONNECTION

The picture below outlines how to connect multiple RC KPS devices to a single KPS amplifier, using a standard PoE network switch and Cat5 cable.

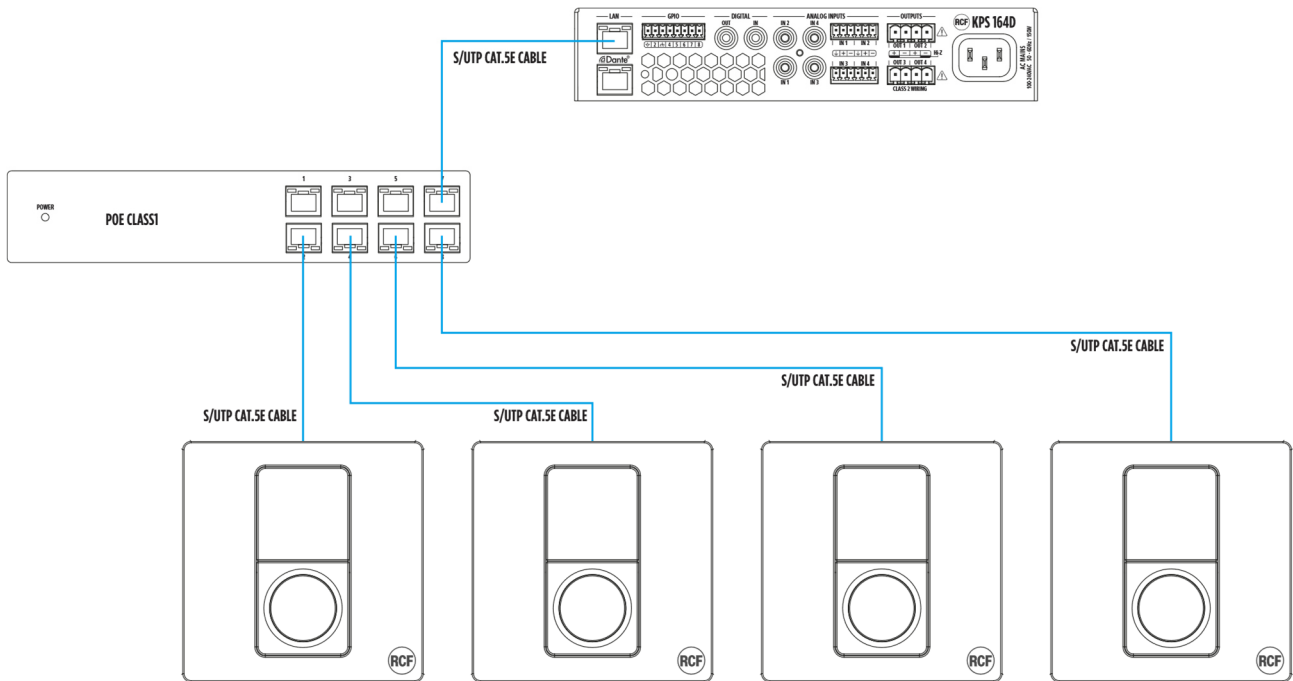

MOUNTING



This product does NOT include the in-wall mounting electrical box and installation screws required to install the controller. Use a commercially available in-wall mounting electrical box and installation screws suitable for the specific wall material and installation situation.

1. Feed the Ethernet cable through the electrical box.

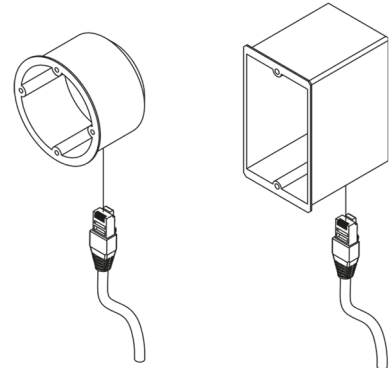

2. Mount the electrical box into the wall.

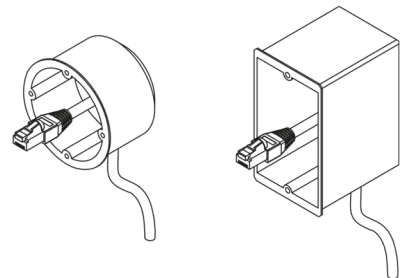

3. Connect the Ethernet cable to the RC KPS unit.

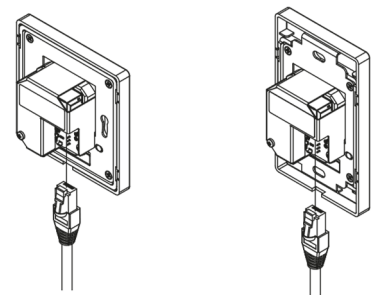

4. Click off the front panel. Screw the RC KPS unit into the electrical box.
5. Put the front panel on and click it into place.

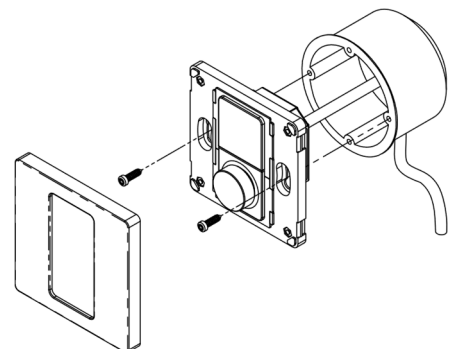

OPERATION

RC KPS has been designed for easy and intuitive operation.

Once installed and configured, the user operates all the device's functions via a highly tactile rotary encoder dial, with all relevant information presented on a high-resolution colour display screen.

- The dial is highly sensitive which makes menu navigation and unit adjustments a frustration-free experience.
- When navigating a menu or adjusting a setting by rotating the encoder dial, the user feels a tactile change in the units via a subtle 'clicking' sensation from the dial through their fingers.
- When operating the device by pressing and releasing the rotary encoder dial, the user can both feel and hear a clear click – thereby confirming the action taken.

Depending on the previous configuration of one single audio zone or multiple audio zones, the device behaves as a single-zone or a multi-zone controller.

Available functions of the device are operated as outlined below.

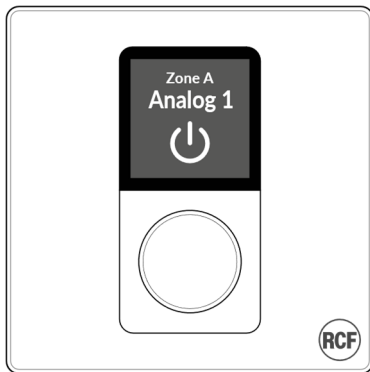

Main screen

Twist the rotary encoder to adjust volume.

Press the rotary encoder once to access the main menu.

Press and hold the rotary encoder to access the settings menu



Main menu

Twist the rotary encoder to select the desired menu item.

Press the rotary encoder once to confirm item selection.

Press and hold the rotary encoder to access the settings menu

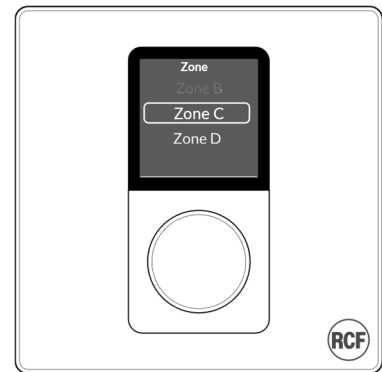

Zone selection menu

Twist the rotary encoder to select zone or input source.

Press the rotary encoder once to confirm item selection.

Press and hold the rotary encoder to access the settings menu



Access to the settings menu can also be restricted via use of optional PIN code protection – activated and configured within the settings of the RDSpace configuration software.

SETUP



When connecting multiple RC KPS devices to a single amplifier, it is recommended completing all stages of the setup process, before connecting and configuring a subsequent device.

START UP DEVICE

Once the RC KPS device is receiving power via the connected Ethernet cable, the product will power up and display the RCF logo for a few seconds. The RCF logo will disappear and be replaced by the setup screen. The setup screen displays the following:

- Device pairing code
- Option to change IP address Edit IP Settings.



EDIT THE DEVICE'S IP SETTING (IF REQUIRED)

When the device is connected to a KPS amplifier via a network router, the RC KPS device will be automatically assigned an IP address (dynamic DHCP)



This is the default setting, and in this situation, there is no need to edit the IP settings.

However, if the device is connected to a KPS amplifier via a network switch, it is necessary to edit the IP settings to static IP.

On initial set-up, this can only be done via the device itself and is performed by following the steps outlined below.

1. Tap the rotary encoder to confirm the action to **Edit IP Settings**.
2. On the display you will be presented with a set of options. Twist the rotary encoder one click to the left (anticlockwise) and tap the rotary encoder to confirm the selection of the option labelled **Mode**.
3. Tap the rotary encoder to confirm the selection of the option labelled **Static**.
4. User will be automatically returned to the previous menu.



Jump to Step 12 if this is not the first device you are connecting to the same amplifier!

5. Twist the rotary encoder 4 clicks to the right (clockwise) to navigate to the option labelled **Back**.
6. Tap the rotary encoder to confirm the selection of the option **Back**.

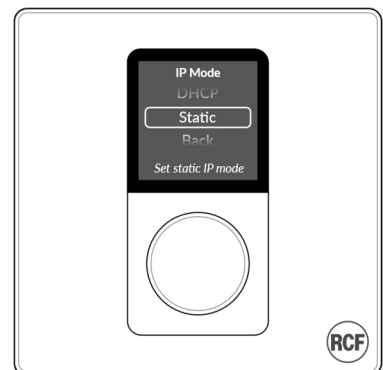
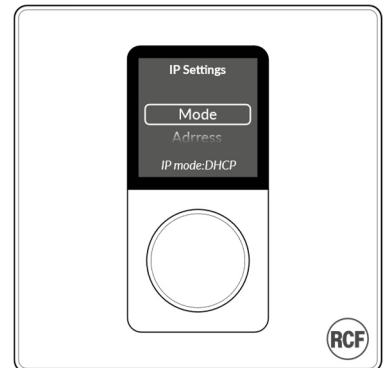

7. The question **Apply IP Changes?** Will be presented.
8. Tap the rotary encoder to confirm the selection of the option labelled **Yes**.



9. That will go back to the same display as at the beginning of the process, showing a pairing code.
Now have been completed the necessary steps for editing the IP settings required when configuring the first device to be connected to the amplifier.

i When connecting more devices to the same amplifier, additional actions, as described below, must be taken after Step 5 to ensure each device has a unique IP address.



10. Twist the rotary encoder one click to the right (clockwise) and tap the rotary encoder to confirm the selection of the option labelled **Address**.



11. Tap the rotary encoder multiple times until the last digit of the IP address is selected.



12. Twist the rotary encoder right (clockwise) to change the final digit of the IP address for this device – so it is not matching those of any other device also linked to the same amplifier. (e.g., for the second device change the final digit to #2; for the second device change the final digit to #3, and so forth).
13. Tap the rotary encoder to confirm the change and exit.
14. Twist the rotary encoder 3 clicks to the right (clockwise) to navigate to the option labelled **Back**.

15. Push the rotary encoder to confirm the selection of the option **Back**.
16. The question **Apply IP Changes?** Will be presented.
17. Twist the rotary encoder one click to the left (anticlockwise) and tap the rotary encoder to confirm the selection of the option labelled **Yes**.



18. It will now be presented the exact same display as at the beginning, showing a pairing code.



Now have been completed all the necessary steps for editing the IP settings required when configuring the second, third or further device to be connected to the amplifier.

CONNECT TO THE AMPLIFIER USING RDSPACE SOFTWARE

If you haven't already, connect now to the KPS amplifier via smartphone, tablet or pc using the RDSpace configuration software. Refer to the quick start guide for a KPS amplifier if a reminder on how to do it is needed.



After connecting to the amplifier, it is strongly recommended changing the Power Management setting to Network Only.

There are two main reasons for this recommendation:

- The default setting labelled **Audio** can potentially block the (optional) function of being able to successfully power down the amplifier directly from the wall controller.
- Setting Power Management to one of the Eco modes **Audio (Eco)** or **Trigger (Eco)** is also not recommended, as under these settings the amplifier can easily lose connection with the networked devices.

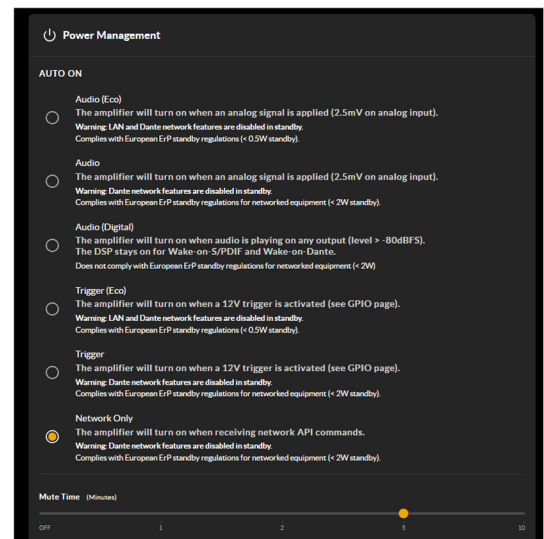



If accessing RDSpace connecting to the amplifier via a wired (Ethernet) network connection, it is strongly recommended changing the WIFI settings as outlined below.

Under the **Settings Menu**, go to **WIFI** settings and select the option **Disable WIFI when LAN connected**. Then click **APPLY** in the upper right-hand corner.

Making this adjustment to the WIFI settings will not only avoid any potential IP address conflict, but also better secure access to the amplifier and its networked devices.

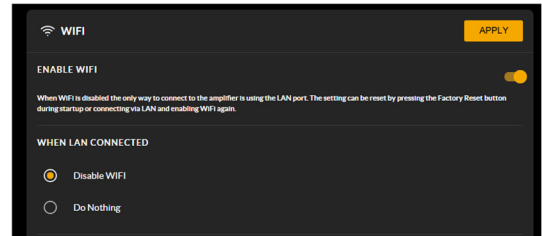

PAIR THE DEVICE WITH THE AMPLIFIER

To pair the RC KPS device with a KPS amplifier, navigate to the menu **Settings > External Devices** in the RDSpace configuration software.

The RC KPS device under configuration will be displayed under **Unpaired** devices.

Pair the device by clicking the button labelled **PAIR** next to the respective RC KPS device.

The process of pairing the RC KPS device with the KPS amplifier takes just a few seconds. Once pairing is successful, the device will be shown under **Paired** devices in the web app, and the green **ONLINE** icon will be displayed alongside it.

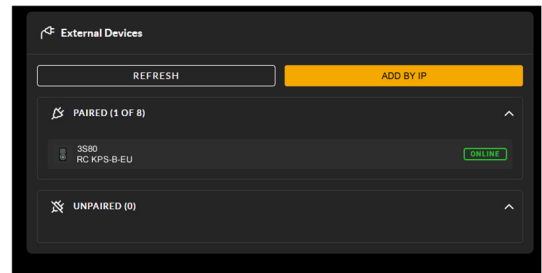
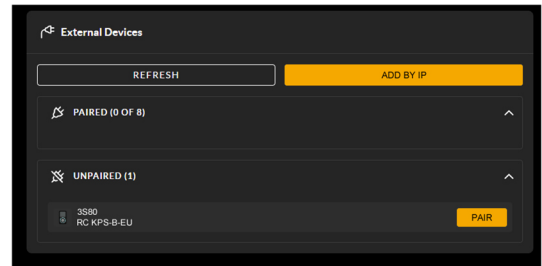

SELECT THE AUDIO ZONE(S) THE DEVICE IS INTENDED TO CONTROL

In the RDSpace configuration software, click on the device shown within the paired devices menu and navigate to the tab labelled **General**.

Assign the device to one or more audio zones, selecting from the drop-down menu which allows multiple selection.



The default selection is **ZONE A**.

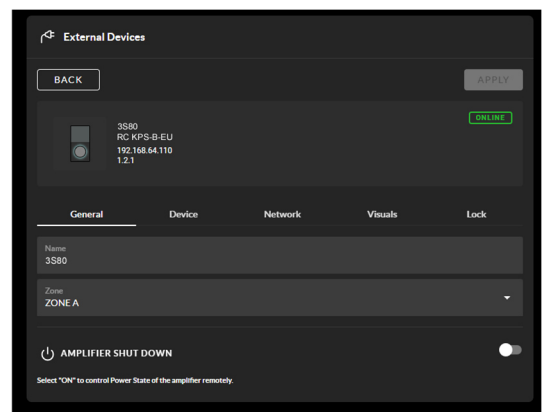

NAME THE DEVICE

Under the tab labelled **General** it is recommended to type in a name for the device.

It is recommended using a name that describes the device's point of installation or usage (e.g., **SPINNING ROOM**).

Click **APPLY** to activate the name change.

The RC KPS device is now configured and able to remotely control the volume and source input of the zone it is associated with.

Individual RC KPS device identification can be established by selecting the **Find Me** option in the **Settings > External Devices > Device** in RDSpace. The display and rotary encoder illumination of the connected device will flash.

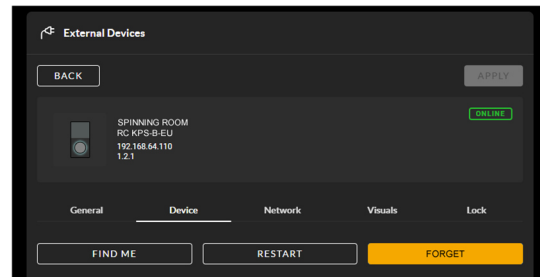
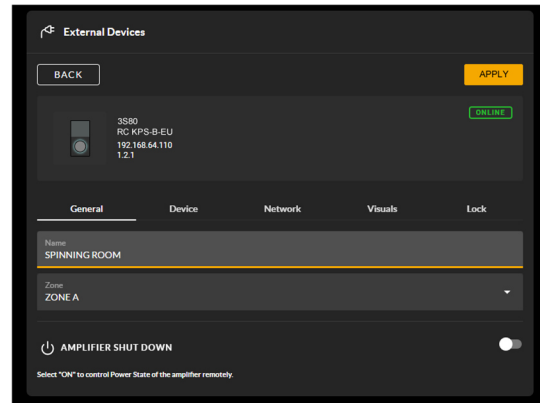

CONFIGURATION

AMPLIFIER POWER ON/OFF FEATURE

The amplifier can be both powered on and off, directly from the RC KPS device. By default, this function is not active and so needs to be first activated within the settings of the device via the RDSpace configuration software.

Under the tab labelled **General** there is an option at the bottom labelled **AMPLIFIER SHUT DOWN**, and a toggle switch to the right.

1. Toggle the switch so it displays as active (yellow). Secondly.
2. Click **APPLY** in the top right-hand corner to activate the feature.

Once the feature has been activated, it is possible for the amplifier to be both powered on and off, directly from the RC KPS device.

To turn the amplifier off (into standby mode), follow the steps outlined below.

1. Press and hold the rotary encoder until the option **Power Off Amp** appears (shows below the setting menu when the feature is activated).
2. Tap the rotary encoder to confirm the selection of the option action **Power Off Amp**.
3. The question **Power Down Amplifier?** will be presented.
4. Twist the rotary encoder to highlight the option **Yes** and tap the rotary encoder to confirm the selection.

When the amplifier is in standby power mode, it will be communicated via both the dashboard section of RDSpace, and on the display screen of the RC KPS device itself.

To turn the amplifier on (back from standby mode), follow the steps outlined below.

1. Tap the rotary encoder.
2. The question **Power Up Amplifier?** will be presented.
3. Twist the rotary encoder to highlight the option **Yes** and tap the rotary encoder to confirm the selection.

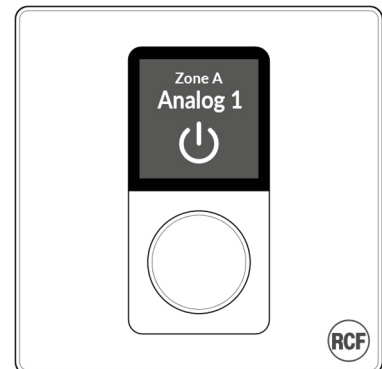
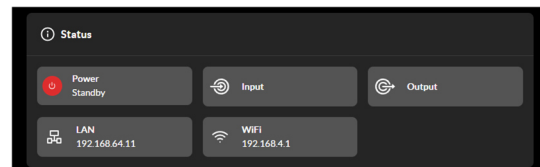
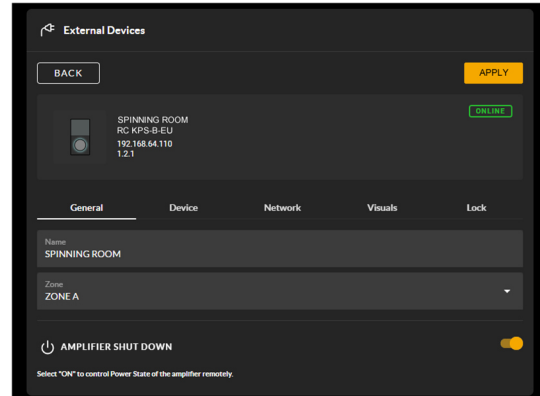

DISPLAY BACKLIGHT BRIGHTNESS

Thanks to the colour LCD display the user can clearly see the zone the controller is associated with, the audio source input that is selected and the current volume level. The high-resolution screen provides enough space for a font size adequate for the user to read and navigate text and menu settings.

The intensity of the display screen's backlight can be adjusted to suit the use environment and user preference. The adjustment can be made directly on the wall controller itself or changed within the RDSpace configuration software.

Three setting levels are possible:

- Low (least bright)
- Medium
- High (most bright)

In the RDSpace configuration software, click on the device shown within the paired devices menu and navigate to the tab labelled **Visuals**. Select the preferred brightness level and, then click the button labelled **APPLY** in the top righthand corner to activate the change.

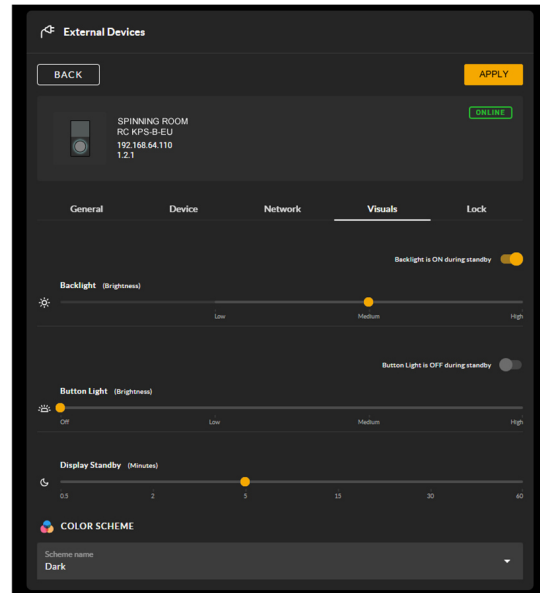

The intensity of the display screen's backlight can also be customized within the settings menu of the RC KPS device. To change the intensity of the display screen's backlight via the RC KPS device, follow the steps outlined below.

1. Press and hold the rotary encoder until the settings menu appears.
2. Tap the rotary encoder to confirm the selection of the **Settings** menu.
3. Tap the rotary encoder to confirm the selection of the **Visuals** menu.
4. Tap the rotary encoder to confirm the selection of the **Backlight** menu.
5. Twist the rotary encoder left and right to explore the options available, as shown on the screen.
6. Tap the rotary encoder to confirm the desired intensity of the display screen's backlight.
7. Twist the rotary encoder one click to the right (clockwise) to navigate to the option labelled **Back**.
8. Tap the rotary encoder to confirm the selection of the option action **Back**.
9. Twist the rotary encoder 2 clicks to the right (clockwise) to navigate to the option labelled **Back**.
10. Tap the rotary encoder to confirm the selection of the option action **Back**.
11. The question **Apply Visual Changes?** Will be presented.
12. Twist the rotary encoder to highlight the option **Yes** and tap the rotary encoder to confirm the selection.
13. Twist the rotary encoder 2 clicks to the right (clockwise) to navigate to the option labelled **Back**.
14. Tap the rotary encoder to confirm the selection of the option action **Back**.
15. The primary screen view displaying the zone, source input and volume level of the associated zone will now be presented.

DISPLAY BACKLIGHT BRIGHTNESS STANDBY

To enhance the user experience, the backlight of the display can also be deactivated, when it is in standby mode. This feature is especially valuable when lighting conditions of the room change – e.g., from bright sunlight during the day to

darker conditions in the evening. Please note that when the backlight is deactivated, the screen appears completely blank to the user, and no longer communicates the zone, source input or volume level of the associated zone.

The adjustment can be made directly on the wall controller itself or changed within the RDSpace configuration software, using the **Visuals** tab.

1. Move the toggle switch to the left – so the text **Backlight is OFF during standby** is displayed.
2. Click the button labelled “APPLY” in the top right-hand corner to activate the feature.

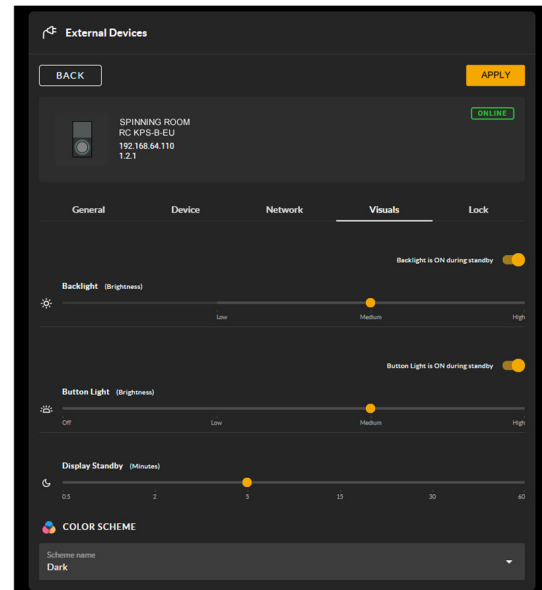

The display screen can also be deactivated when the display is in standby mode within the settings menu of the RC KPS device itself.

To deactivate the screen display when the display is in standby mode via the RC KPS device, simply follow the steps outlined below.

1. Press and hold the rotary encoder until the settings menu appears.
2. Tap the rotary encoder to confirm the selection of the **Settings** menu.
3. Tap the rotary encoder to confirm the selection of the **Visuals** menu.
4. Tap the rotary encoder to confirm the selection of the **Backlight** menu.
5. Twist the rotary encoder one click to the left (anticlockwise) to navigate to the option labelled **Standby**.
6. Tap the rotary encoder to confirm the selection of the **Standby** menu.
7. Twist the rotary encoder left and right to toggle between the display standby options **ON** and **OFF**.
8. Tap the rotary encoder to confirm your preferred display standby setting (ON means display screen backlight remains on even when RC KPS device is in standby mode).
9. Twist the rotary encoder 2 clicks to the right (clockwise) to navigate to the option labelled **Back**.
10. Tap the rotary encoder to confirm the selection of the option action **Back**.
11. Twist the rotary encoder 2 clicks to the right (clockwise) to navigate to the option labelled **Back**.
12. Tap the rotary encoder to confirm the selection of the option action **Back**.
13. The question **Apply Visual Changes?** Will be presented.
14. Twist the rotary encoder to highlight the option Yes and tap the rotary encoder to confirm the selection.
15. Twist the rotary encoder 2 clicks to the right (clockwise) to navigate to the option labelled **Back**.
16. Tap the rotary encoder to confirm the selection of the option action **Back**.
17. The primary screen view displaying the zone, source input and volume level of the associated zone will now be presented.

ENCODER BACKLIGHT BRIGHTNESS

The intensity of the backlight behind the rotary encoder dial can be adjusted to suit the use environment and user preference. Four setting levels are possible:

- Off (no light)
- Low (least bright)
- Medium
- High (most bright)

The adjustment can be made directly on the wall controller itself or changed within the RDSpace configuration software.

The intensity of rotary encoder dial backlight can be quickly changed via the slider located at in the centre of the **Visuals** tab.

1. Choose the preferred brightness level
2. Click the button labelled **APPLY** in the top right-hand corner to activate the change.

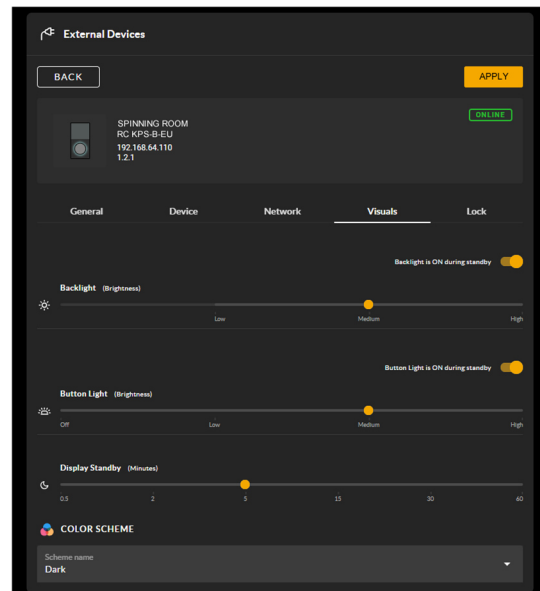

The intensity of the back-light behind the rotary encoder dial can also be customized within the settings menu of RC KPS device. To change the intensity of the backlight behind the rotary encoder dial via the RC KPS device, simply follow the steps outlined below.

1. Press and hold the rotary encoder until the settings menu appears.
2. Tap the rotary encoder to confirm the selection of the **Settings** menu.
3. Tap the rotary encoder to confirm the selection of the **Visuals** menu.
4. Twist the rotary encoder one click to the right (clockwise) and tap the rotary encoder to confirm the selection of the option labelled **Button Light**.
5. Tap the rotary encoder to confirm the selection of the option labelled **Brightness**.
6. Tap the rotary encoder to confirm the selection of the **Brightness** menu.
7. Twist the rotary encoder left and right to toggle between the four options **OFF; LOW; MID; HIGH**.
8. Tap the rotary encoder to confirm your preferred setting.
9. Twist the rotary encoder 1 click to the right (clockwise) to navigate to the option labelled **Back**.
10. Tap the rotary encoder to confirm the selection of the option action **Back**.
11. Twist the rotary encoder 1 click to the right (clock wise) to navigate to the option labelled **Back**.
12. Tap the rotary encoder to confirm the selection of the option action **Back**.
13. The question **Apply Visual Changes?** Will be presented.
14. Twist the rotary encoder to highlight the option **Yes** and tap the rotary encoder to confirm the selection.
15. Twist the rotary encoder 2 clicks to the right (clockwise) to navigate to the option labelled **Back**.
16. Tap the rotary encoder to confirm the selection of the option action **Back**.

17. The primary screen view displaying the zone, source input and volume level of the associated zone will now be presented.

ENCODER BACKLIGHT BRIGHTNESS STANDBY

To facilitate the ideal user experience, the backlight of the rotary encoder dial can also be deactivated, when the display is in standby mode. This feature is especially valuable when lighting conditions of the room change – e.g., from bright sunlight during the day to darker conditions in the evening.

The adjustment can be made directly on the wall controller itself or changed within the RDSpace configuration software.

1. Move the toggle switch to the left – so the text **Button Light is OFF during standby** is displayed.
2. Click the button labelled **APPLY** in the top right-hand corner to activate the feature.

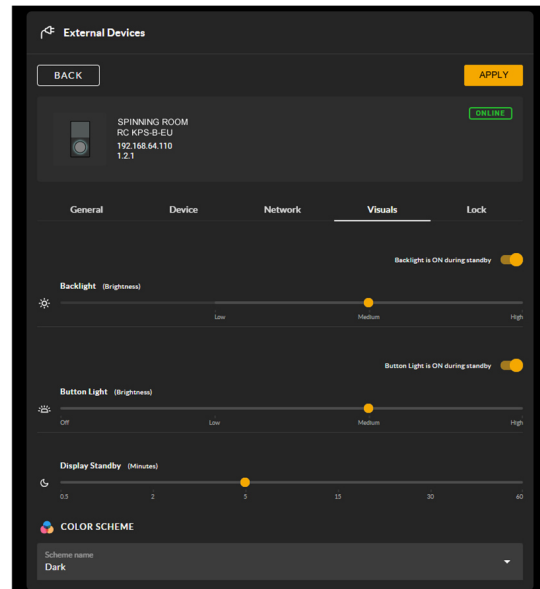

The backlight of the rotary encoder dial can also be deactivated when the display is in standby mode, within the settings menu of the RC KPS device itself.

To deactivate the backlight of the rotary encoder dial when the display is in standby mode via the RC KPS device, simply follow the steps outlined below.

1. Press and hold the rotary encoder until the settings menu appears.
2. Tap the rotary encoder to confirm the selection of the **Settings** menu.
3. Tap the rotary encoder to confirm the selection of the **Visuals** menu.
4. Twist the rotary encoder one click to the right (clockwise) and tap the rotary encoder to confirm the selection of the option labelled **Button Light**.
5. Twist the rotary encoder one click to the left (anticlockwise) and tap the rotary encoder to confirm the selection of the option labelled **Standby**.
6. Twist the rotary encoder left and right to toggle between the display standby options **ON** and **OFF**.
7. Tap the rotary encoder to confirm your preferred display standby setting (ON means the rotary encoder dial backlight remains on even when RC KPS device is in standby mode).
8. Twist the rotary encoder 2 clicks to the right (clockwise) to navigate to the option labelled **Back**.
9. Tap the rotary encoder to confirm the selection of the option action **Back**.
10. Twist the rotary encoder 1 click to the right (clockwise) to navigate to the option labelled **Back**.
11. Tap the rotary encoder to confirm the selection of the option action **Back**.
12. The question **Apply Visual Changes?** Will be presented.
13. Twist the rotary encoder to highlight the option **Yes** and tap the rotary encoder to confirm the selection.
14. Twist the rotary encoder 2 clicks to the right (clockwise) to navigate to the option labelled **Back**.
15. Tap the rotary encoder to confirm the selection of the option action **Back**.

16. The primary screen view displaying the zone, source input and volume level of the associated zone will now be presented.

DISPLAY SCREEN COLOUR SCHEME

Thanks to the colour LCD display the user can clearly see the zone the controller is associated with, the audio source input that is selected and the current volume level. The high-resolution screen provides enough space for a font size adequate for the user to read and navigate text and menu settings. A choice of four different colour schemes also provides the possibility to customize the display to best match the use environment and/or personal preference.

- BLUE = White Text on Blue Background.
- DARK = White Text on Dark Grey Background.
- LIGHT = Black Text on Light Grey Background.
- ORANGE= Orange Text on Dark Grey Background.

The default colour scheme is set to **DARK**.

Customization can be made within the RDSpace configuration software, or directly via the RC KPS device.

Using RDSpace, the colour scheme can be quickly changed via the drop-down menu located at the bottom of the **Visuals** tab.

1. Choose the preferred colour scheme
2. Click the button labelled **APPLY** in the top right-hand corner to activate the change.

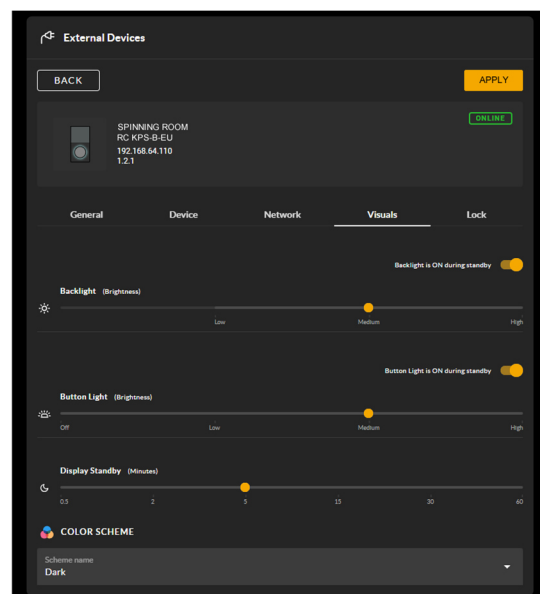

The colour scheme can also be customized within the settings menu of the RC KPS device itself. To change the screen colour scheme via the RC KPS device, simply follow the steps outlined below.

1. Press and hold the rotary encoder until the settings menu appears.
2. Tap the rotary encoder to confirm the selection of the **Settings** menu.
3. Tap the rotary encoder to confirm the selection of the **Visuals** menu.
4. Twist the rotary encoder one click to the left (anticlockwise) and tap the rotary encoder to confirm the selection of the option labelled **Color Scheme**.
5. Twist the rotary encoder left and right to explore the options available, as shown on the screen.
6. Tap the rotary encoder to confirm the desired colour scheme.
7. Twist the rotary encoder to the right (clockwise) until you have navigated to the option labelled **Back**.
8. Tap the rotary encoder to confirm the selection of the option action **Back**.
9. Twist the rotary encoder 3 clicks to the right (clockwise) to navigate to the option labelled **Back**.
10. Tap the rotary encoder to confirm the selection of the option action **Back**.
11. the question **Apply Visual Changes?** Will be presented.
12. Twist the rotary encoder to highlight the option Yes and tap the rotary encoder to confirm the selection.
13. Twist the rotary encoder 2 clicks to the right (clockwise) to navigate to the option labelled **Back**.

14. Tap the rotary encoder to confirm the selection of the option action **Back**.
15. The primary screen view displaying the zone, source input and volume level of the associated zone will now be presented.

LOCAL USER LOCK AND UNLOCK (PIN CODE PROTECTION)

A 4-digit numerical pin code can be set, reset, and enabled within the RDSpace software to restrict usage of the device.

When enabled, no one can operate the device and/or adjust the settings - unless they are able to enter the correct PIN code. This makes it possible to place devices in areas where unauthorized room users have easy access to the device.

Note that the PIN code can always be reset via the RDSpace configuration software. This solves the problem of potentially forgotten PIN codes, whilst also providing the opportunity to change the PIN code if circumstances change.

The PIN code protection can either be kept deactivated (**OFF**) or applied at three distinct levels: **Settings Only**; **All Access**, and **All Access (Dual PIN)**.

SETTINGS ONLY PROTECTION

Typical Use Case Scenario: Example – RC KPS devices are placed within easy reach of authorized users (e.g., workers) of a restaurant. Enabling the local user lock function and setting it to **Settings Only** allows the users to adjust volume and switch audio source, but prevents the users being able to customize the device, change critical settings or reset the device.

- All functions of the wall controller are available, and the device remains completely unlocked for use by any user with physical access to the device.
- Only when the user attempts to access the **Settings** menu are they prompted to enter the correct PIN code on the device – turning the rotary encode dial to select each digit on the screen; and pushing the dial to confirm each digit.
- If successfully unlocked, all functions under the settings menu become accessible.
- Until the correct PIN code is entered, the functions inaccessible to the user include:
 - Visuals (settings relating to customization of standby, backlights and colour scheme).
 - Reset Device (ability to completely reset the device).
 - IP Settings (ability to adjust the IP settings of the device).

1. Navigate to the **Lock** tab and select the option **Settings Only** shown under the headline **CONTROLLER LOCK ENABLE**.
2. Type into the box labelled **PIN Code** a 4-digit PIN code (it is recommended changing the PIN code, otherwise it will remain '0000').
3. Click the button labelled **APPLY** in the top right-hand corner to activate the feature as configured.

 **Auto Lock** function is NOT an available option under this second level. The locking of the settings menu applies all the time, from the instant the option is applied in RDSpace.

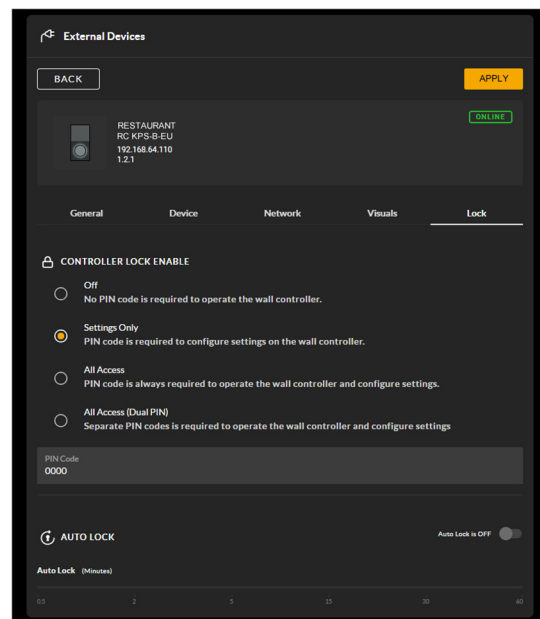

ALL ACCESS PROTECTION

Typical Use Case Scenario: Example – RC KPS devices are placed within easy reach of customers of a restaurant. Enabling the local user lock function and setting it to **All Access** prevents the possibility of customers adjusting the volume, switching the audio source, or making any other adjustment to the installed system.

- Until unlocked, none of the functions of the RC KPS device can be accessed.
- If a user attempts to use the device, they are prompted to enter the correct PIN code on the device – turning the rotary encode dial to select each digit on the screen; and pushing the dial to confirm each digit.
- Once successfully unlocked, functions become accessible.
- To enter the **Settings** menu you will be prompted to enter the PIN code again – this helps ensure the security of the device whilst the Auto Lock function is off.

1. Navigate to the **Lock** tab and select the option **All Access** shown under the headline **CONTROLLER LOCK ENABLE**.

2. Type into the box labelled **PIN Code** a 4-digit PIN code (it is recommended changing the PIN code, otherwise it will remain '0000').

3. Toggle to the right the switch labelled **Auto Lock** – it will turn yellow (active) and display the label **Auto Lock is ON**.

4. Using the slider, select the desired period of time to elapse before the controller is locked, and thus requiring the entering of the correct PIN code to unlock. (it is recommended that under many circumstances the shortest period of 30 seconds would be suitable).

5. Finally, click the button labelled **APPLY** in the top right-hand corner to activate the feature as configured.

6. Once activated, it can be chosen to manually lock the device immediately, or let the device automatically lock itself after the period of period of time selected on the **Auto Lock** slider.

7. To manually lock the device immediately, do as described.

- Press and hold the rotary encoder of the device until the option Lock Controller appears on the display screen.
- Tap the rotary encoder to confirm the action to Lock Controller - you will be immediately presented with the message Controller Locked, and thereafter a padlock icon will appear on the display screen of the device; indicating the device is now locked - thus requiring the entering of a PIN code to unlock.

8. To let the device automatically lock itself wait until the period of time selected on the Auto Lock slider has elapsed. User will subsequently notice a padlock icon appear on the display screen of the device, indicating the device requires the entering of a PIN code to unlock.

9. To unlock the device, the user must enter the correct PIN code on the device. This is performed by turning the rotary encode dial to select each digit on the screen; and pushing the dial to confirm each digit.

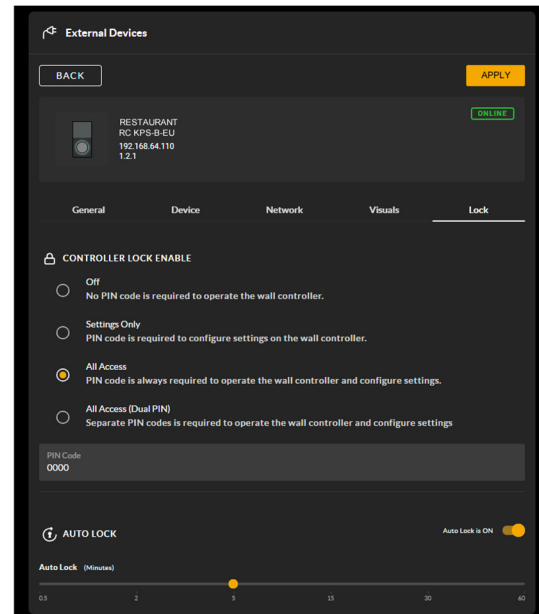

ALL ACCESS (DUAL PIN) PROTECTION

A further level of security is available enabling different PIN controlled access to RC KPS operation and settings.

This option enables, for example, operators with different responsibilities to have access only to the functions appropriate to their roles.

This setup is carried out in a similar manner to previous ones.

The only difference is that **two four digit PINs are required**.

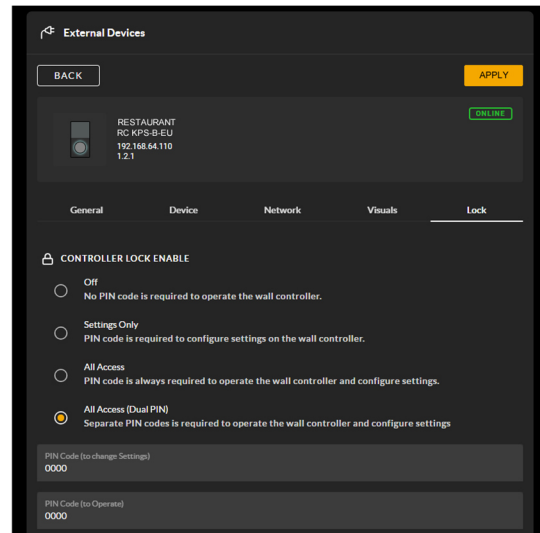

VOLUME CONTROL (RANGE) LIMITATION

A lower (minimum) and upper (maximum) volume limitation can be applied to the zone the device is configured to control.

This feature is especially valuable in scenarios where the total power of the channel output greatly exceeds the volume suitable for the installation environment.

The feature is also very useful to apply in scenarios where it is preferred the volume does not fall below a certain level - with the exception of complete muting.

Within the RDSpace configuration software, this feature can be found by navigating to the volume menu of the **Zone Tab**.

The minimum and maximum volume limits are set using a slider found within the section labelled **RANGE**. For accuracy, volume settings are displayed in decibels (dB).

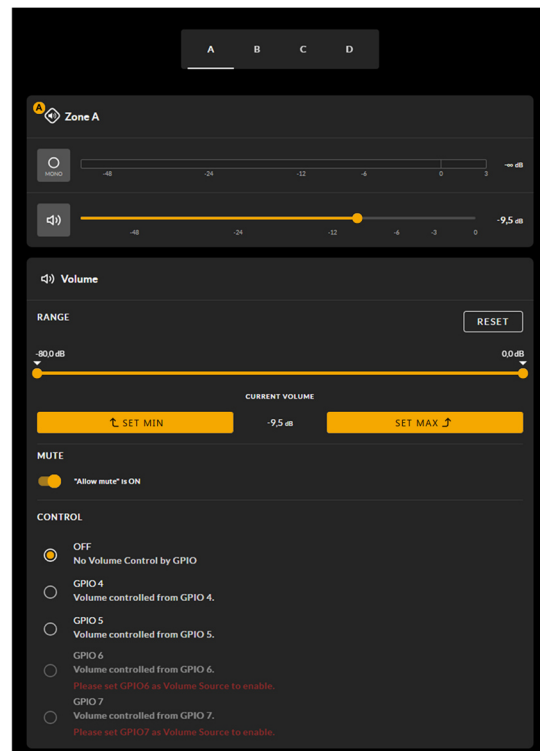

On the device, the end user is made visually aware of the volume range limitation when adjusting the volume level.

Note that as a convenience to the user, the volume settings on the device are always displayed as a relative level on a scale of 0 – 100, rather than in decibels.

Note that if the volume is turned below the minimum level, the output is completely muted, and the mute icon is shown on the display screen.

It is also possible to disable the amplifier zone mute function.

This can be particularly significant in situations where important information potentially needs to be heard in a specific zone. To disable or enable the mute function, toggle the **Allow mute** switch in Volume menu of the **Zone Tab**.



RESET

It is possible to reset a RC KPS device back to its factory-default state.



When resetting the device, any previous settings including IP address information is cleared.



The use of this function is only required in exceptional circumstances whereby a complete device reset is necessary.

To perform a complete device reset, follow the steps outlined below.

1. Press and hold the rotary encoder until the **Settings** menu appears.
2. Tap the rotary encoder to confirm the selection of the **Settings** menu.
3. Twist the rotary encoder one click to the left (anticlockwise) and tap the rotary encoder to confirm the selection of the option labelled **Reset Device**.
4. Tap the rotary encoder to confirm the selection of the option action **Reset Device**.
5. The question **Reset to Factory Defaults?** will be presented.
6. Twist the rotary encoder to highlight the option **Yes** and tap the rotary encoder to confirm the selection.
7. After a few seconds the device will turn off, then restart and show a new pairing code on the display screen.
8. In RDSpace, the device just reset shows up with a red box stating the device is **Offline**.
9. In the RDSpace, click on the device and navigate to the **Device** tab.
10. In the bottom right-hand corner of the device tab there is a red button labelled **Forget Device** – click this to completely remove the device from the system.

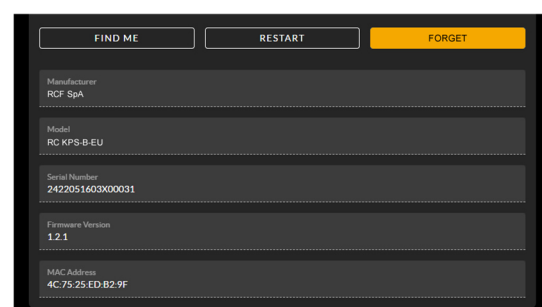
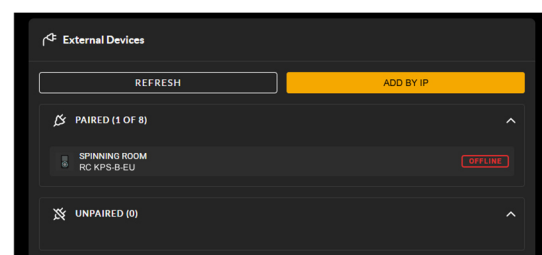

11. A green pop-up will state **DEVICE WAS UNPAIRED** confirms the completion of the process.

12. The device is now ready to be re-paired and configured.

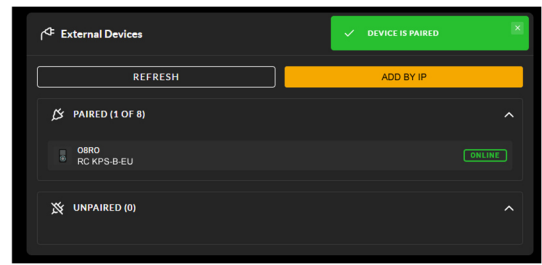
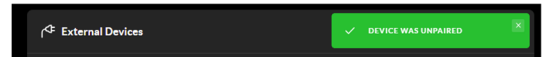

DIMENSIONS

RC KPS EU

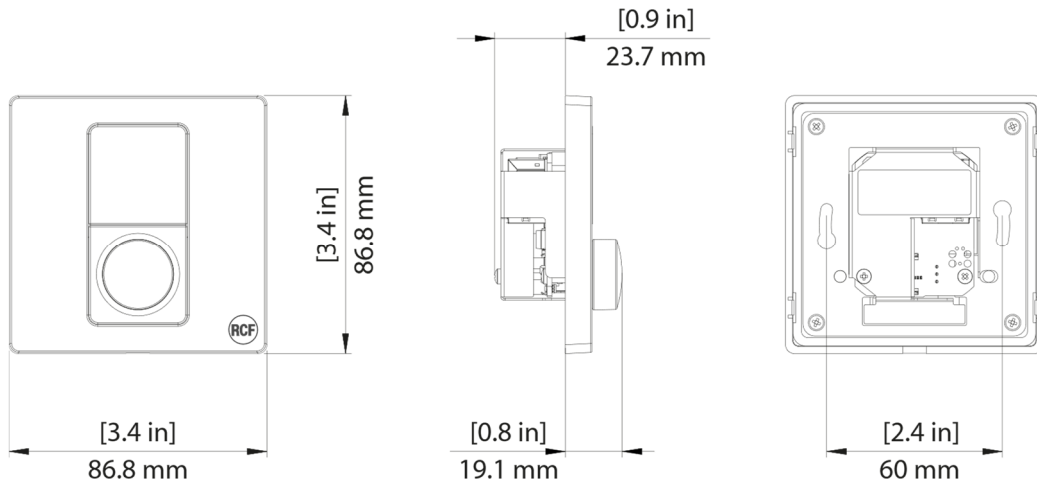

RC KPS US

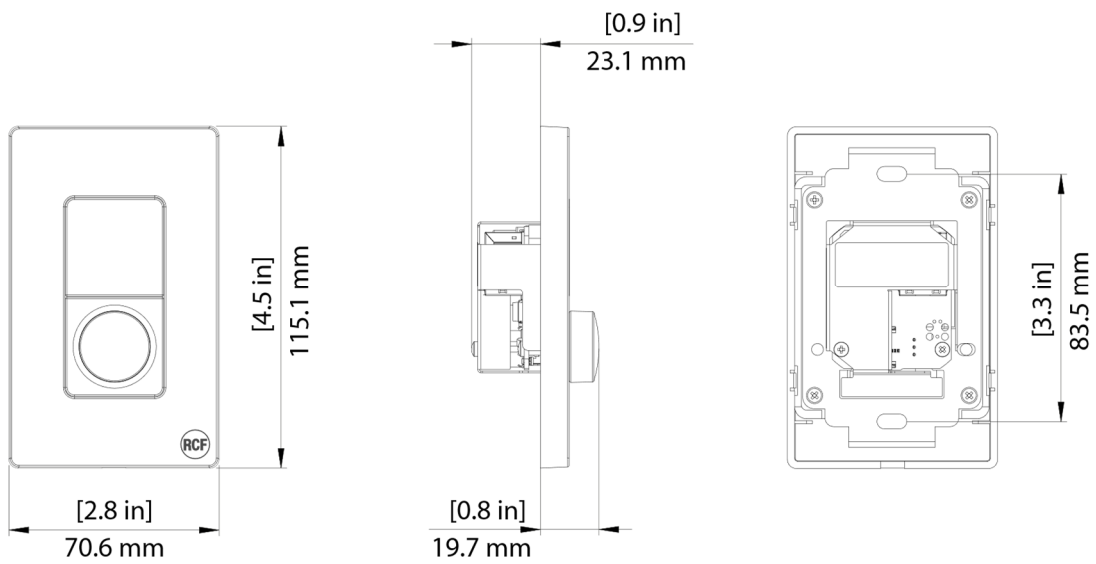

SPECIFICATIONS

	RC KPS EU	RC KPS US
General specifications		
Functions	Volume control Mute Source selection Stand-by	Volume control Mute Source selection Stand-by
Installation	Compatible with EU installation standard	Compatible with US installation standard
Work with	KPS series amplifiers	KPS series amplifiers
Number of connectable item	Up to 8 controllers for each amplifier	Up to 8 controllers for each amplifier
Connector	RJ45	RJ45
Max cable length (CAT 5e)	100 m	100 m
Power supply	PoE Class I device, 48V	PoE Class I device, 48V
Power consumption	3.84Wmax	3.84Wmax
Standard compliance		
IP protection grade	IP 30	IP 30
Safety agency	CE compliant	CE compliant
Physical specifications		
Cabinet/Case Material	Plastic	Plastic
Colour	Black - RAL 9005 White - RAL 9003	Black - RAL 9005 White - RAL 9003
Size / Weight		
Height	86.8 mm / 3.42 inches	115.1 mm / 4.53 inches
Width	86.8 mm / 3.42 inches	70.6 mm / 2.78 inches
Depth	42.8 mm / 1.69 inches	42.8 mm / 1.69 inches
Recessed Depth	23.7 mm / 0.93 inches	23.1 mm / 0.91 inches
Weight	0.12 kg / 0.26 lbs	0.12 kg / 0.26 lbs

