

dbx[®]
by HARMAN

120A

**Subharmonic
Synthesizer**
with
Modeled Waveform Synthesis™



→ *User Manual*

IMPORTANT SAFETY INFORMATION

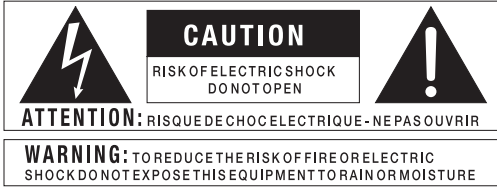

The symbols shown above are internationally accepted symbols that warn of potential hazards with electrical products. The lightning flash with arrowpoint in an equilateral triangle means that there are dangerous voltages present within the unit. The exclamation point in an equilateral triangle indicates that it is necessary for the user to refer to the owner's manual.

These symbols warn that there are no user serviceable parts inside the unit. Do not open the unit. Do not attempt to service the unit yourself. Refer all servicing to qualified personnel. Opening the chassis for any reason will void the manufacturer's warranty. Do not get the unit wet. If liquid is spilled on the unit, shut it off immediately and take it to a dealer for service. Disconnect the unit during storms to prevent damage.

SAFETY INSTRUCTIONS

NOTICE FOR CUSTOMERS IF YOUR UNIT IS EQUIPPED WITH A POWER CORD.

WARNING: THIS APPLIANCE SHALL BE CONNECTED TO A MAINS SOCKET OUTLET WITH A PROTECTIVE EARTHING CONNECTION.

The cores in the mains lead are coloured in accordance with the following code:

GREEN and YELLOW - Earth BLUE - Neutral BROWN - Live

As colours of the cores in the mains lead of this appliance may not correspond with the coloured markings identifying the terminals in your plug, proceed as follows:

- The core which is coloured green and yellow must be connected to the terminal in the plug marked with the letter E, or with the earth symbol, or coloured green, or green and yellow.
- The core which is coloured blue must be connected to the terminal marked N or coloured black.
- The core which is coloured brown must be connected to the terminal marked L or coloured red.

This equipment may require the use of a different line cord, attachment plug, or both, depending on the available power source at installation. If the attachment plug needs to be changed, refer servicing to qualified service personnel who should refer to the table below. The green/yellow wire shall be connected directly to the units chassis.

CONDUCTOR		WIRE COLOR	
		Normal	Alt
L	LIVE	BROWN	BLACK
N	NEUTRAL	BLUE	WHITE
E	EARTH GND	GREEN/ YEL	GREEN

WARNING: If the ground is defeated, certain fault conditions in the unit or in the system to which it is connected can result in full line voltage between chassis and earth ground. Severe injury or death can then result if the chassis and earth ground are touched simultaneously.

WARNING FOR YOUR PROTECTION READ THE FOLLOWING:

KEEP THESE INSTRUCTIONS

HEED ALL WARNINGS

FOLLOW ALL INSTRUCTIONS

THE APPARATUS SHALL NOT BE EXPOSED TO DRIPPING OR SPLASHING LIQUID AND NO OBJECT FILLED WITH LIQUID, SUCH AS VASES, SHALL BE PLACED ON THE APPARATUS.

CLEAN ONLY WITH A DRY CLOTH.

DO NOT BLOCK ANY OF THE VENTILATION OPENINGS. INSTALL IN ACCORDANCE WITH THE MANUFACTURER'S INSTRUCTIONS.

DO NOT INSTALL NEAR ANY HEAT SOURCES SUCH AS RADIATORS, HEAT REGISTERS, STOVES, OR OTHER APPARATUS (INCLUDING AMPLIFIERS) THAT PRODUCE HEAT.

ONLY USE ATTACHMENTS/ACCESSORIES SPECIFIED BY THE MANUFACTURER.

UNPLUG THIS APPARATUS DURING LIGHTNING STORMS OR WHEN UNUSED FOR LONG PERIODS OF TIME.

Do not defeat the safety purpose of the polarized or grounding-type plug. A polarized plug has two blades with one wider than the other. A grounding type plug has two blades and a third grounding prong. The wide blade or third prong are provided for your safety. If the provided plug does not fit your outlet, consult an electrician for replacement of the obsolete outlet.

Protect the power cord from being walked on or pinched particularly at plugs, convenience receptacles, and the point where they exit from the apparatus.

Use only with the cart stand, tripod bracket, or table specified by the manufacturer, or sold with the apparatus. When a cart is used, use caution when moving the cart/apparatus combination to avoid injury from tip-over.



Refer all servicing to qualified service personnel. Servicing is required when the apparatus has been damaged in any way, such as power-supply cord or plug is damaged, liquid has been spilled or objects have fallen into the apparatus, the apparatus has been exposed to rain or moisture, does not operate normally, or has been dropped.

POWER ON/OFF SWITCH: If the equipment has a Power switch, the Power switch used in this piece of equipment DOES NOT break the connection from the mains.

MAINS DISCONNECT: The plug shall remain readily operable. For rack-mount or installation where plug is not accessible, an all-pole mains switch with a contact separation of at least 3 mm in each pole shall be incorporated into the electrical installation of the rack or building.

FOR UNITS EQUIPPED WITH EXTERNALLY ACCESSIBLE FUSE RECEPTACLE: Replace fuse with same type and rating only.

MULTIPLE-INPUT VOLTAGE: This equipment may require the use of a different line cord, attachment plug, or both, depending on the available power source at installation. Connect this equipment only to the power source indicated on the equipment rear panel. To reduce the risk of fire or electric shock, refer servicing to qualified service personnel or equivalent.

If connected to 240V supply, a suitable CSA/UL certified power cord shall be used for this supply.

IMPORTANT SAFETY INFORMATION

ELECTROMAGNETIC COMPATIBILITY

This unit conforms to the Product Specifications noted on the **Declaration of Conformity**. Operation is subject to the following two conditions:

- this device may not cause harmful interference, and
- this device must accept any interference received, including interference that may cause undesired operation.

Operation of this unit within significant electromagnetic fields should be avoided.

- use only shielded interconnecting cables.

U.K. MAINS PLUG WARNING

A molded mains plug that has been cut off from the cord is unsafe. Discard the mains plug at a suitable disposal facility.

NEVER UNDER ANY CIRCUMSTANCES SHOULD YOU INSERT A DAMAGED OR CUT MAINS PLUG INTO A 13 AMP POWER SOCKET.

Do not use the mains plug without the fuse cover in place. Replacement fuse covers can be obtained from your local retailer. Replacement fuses are 13 amps and **MUST** be ASTA approved to BS1362.



If you want to dispose this product, do not mix it with general household waste. There is a separate collection system for used electronic products in accordance with legislation that requires proper treatment, recovery and recycling.

Private household in the 25 member states of the EU, in Switzerland and Norway may return their used electronic products free of charge to designated collection facilities or to a retailer (if you purchase a similar new one).

For Countries not mentioned above, please contact your local authorities for a correct method of disposal.

By doing so you will ensure that your disposed product undergoes the necessary treatment, recovery and recycling and thus prevent potential negative effects on the environment and human health.

DECLARATION OF CONFORMITY

Manufacturer's Name: dbx Professional Products
Manufacturer's Address: 8760 S. Sandy Parkway
Sandy, Utah 84070, USA

declares that the product:

Product name: dbx 120A

Note: Product name may be suffixed by the EU.

Product option: None

conforms to the following Product Specifications:

Safety: IEC 60065 -01+Amd 1

EMC: EN 55022:2006 (N/A; Analog Product)
IEC61000-4-2
IEC61000-4-3
IEC61000-4-4
IEC61000-4-5
IEC61000-4-6
IEC61000-4-8
IEC61000-4-11

Supplementary Information:

The product herewith complies with the requirements of the:

Low Voltage Directive 2006/95/EC

EMC Directive 2004/108/EC.

RoHS Directive 2002/95/EC

WEEE Directive 2002/96/EC

With regard to Directive 2005/32/EC and EC Regulation 1275/2008 of 17 December 2008, this product is designed, produced, and classified as Professional Audio Equipment and thus is exempt from this Directive.

Roger Johnsen
Vice President of Engineering
8760 S. Sandy Parkway
Sandy, Utah 84070, USA
Date: November 1, 2010

European Contact: Your local dbx Sales and Service Office or

Harman Music Group
8760 South Sandy Parkway
Sandy, Utah 84070, USA
Ph: (801) 566-8800
Fax: (801) 568-7583

Introduction

0.1 Defining the 120A.....i

0.2 Service Contact Info.....ii

0.3 Warranty.....ii

Section I - Operation and Appendix

1.1 Rear Panel Connections.....1

1.2 Front Panel Connections1

1.3 Operating Notes2

1.4 Basic Connection4

Appendix

A.1 Block Diagram.....5

A.2 Specifications6

A.3 Wiring Diagrams7

120A

INTRODUCTION

INTRO

CUSTOMER SERVICE INFO
120A DEFINED
WARRANTY INFO



dbx[®]
by HARMAN

INTRODUCTION

Congratulations on your purchase of the dbx® Professional Products 120A Subharmonic Synthesizer with Modeled Waveform Synthesis™. The 120A has been specifically optimized to enhance Bass audio material for use in a variety of professional applications, including night-club and dance DJ mixing, theatre and film sound, music recording, live music performance and broadcasting.

The 120A's two separate bands of subharmonic synthesis provide the best combination of smoothness and control, and the independent low frequency boost circuit is designed to get the most out of high-performance low frequency speaker systems. Flexible system interfacing is achieved by providing main outputs which can be full range (including synthesis) or high-frequency ONLY, along with a separate subwoofer output with its own level control.

This manual will be your guide to understanding the full functionality of the powerful 120A. After you have become familiar with the unit, we encourage you to experiment and find creative ways that the 120A can help you optimize your specific application.

The 120A's patented modeled Waveform Synthesis™ process builds a synthesized waveform using the wave shapes of the original bass material, producing a new Waveform Modeled™ bass note, exactly one octave below the bass in the original audio signal path. Unlike other attempts at bass synthesis, the dbx Professional Products 120A process produces smooth, musical low frequencies that do not interfere with mid and high-band information even when the maximum synthesis and boost are applied. The result is a low-end punch that people really feel, even at system levels that won't destroy sound equipment or damage hearing. The 120A offers the following features:

- ***Patented Modeled Waveform Synthesis™ Circuitry insures that mid and high frequencies are not affected***
- ***Individual Controls for Two Separate ranges of Subharmonic Frequencies, plus Master Synthesis Level Control***
- ***Separate Low Frequency Boost Circuit***
- ***Separate Subwoofer Output***
- ***1/4" Balanced Inputs and 1/4" Impedance-Balanced Outputs***
- ***RCA Inputs***
- ***LF Synthesis LED Indicators***
- ***Selectable Crossover with 80Hz and 120Hz crossover points***

0.2 Service Contact Info

If you require technical support, contact dbx Customer Service. Be prepared to accurately describe the problem. Know the serial number of your unit. This is printed on a sticker attached to the rear panel. If you have not already taken the time to fill out your warranty registration card and send it in, please do so now.

Before you return a product to the factory for service, we recommend you refer to the manual. Make sure you have correctly followed installation steps and operation procedures. If you are still unable to solve a problem, contact our Customer Service Department at (801) 568-7660 for consultation. If you need to return a product to the factory for service, you **MUST** contact Customer Service to obtain a Return Authorization Number.

No returned products will be accepted at the factory without a Return Authorization Number.

Please refer to the warranty below, which extends to the first end-user. After expiration of the warranty, a reasonable charge will be made for parts, labor, and packing if you choose to use the factory service facility. In all cases, you are responsible for transportation charges to the factory. dbx will pay return shipping if the unit is still under warranty.

Use the original packing material if it is available. Mark the package with the name of the shipper and with these words in red: DELICATE INSTRUMENT, FRAGILE! Insure the package properly. Ship prepaid, not collect. Do not ship parcel post.

0.3 Warranty

This warranty is valid only for the original purchaser and only in the United States.

- 1). The warranty registration card that accompanies this product must be mailed within 30 days after purchase date to validate this warranty. Proof-of-purchase is considered to be the burden of the consumer.
- 2). dbx warrants this product, when bought and used solely within the U.S., to be free from defects in materials and workmanship under normal use and service.
- 3). dbx liability under this warranty is limited to repairing or, at our discretion, replacing defective materials that show evidence of defect, provided the product is returned to dbx WITH RETURN AUTHORIZATION from the factory, where all parts and labor will be covered up to a period of two years. A Return Authorization number must be obtained from dbx by telephone. The company shall not be liable for any consequential damage as a result of the product's use in any circuit or assembly.
- 4). dbx reserves the right to make changes in design or make additions to or improvements upon this product without incurring any obligation to install the same additions or improvements on products previously manufactured.
- 5). The foregoing is in lieu of all other warranties, expressed or implied, and dbx neither assumes nor authorizes any person to assume on its behalf any obligation or liability in connection with the sale of this product. In no event shall dbx or its dealers be liable for special or consequential damages or from any delay in the performance of this warranty due to causes beyond their control.

120A



dbx[®]
by HARMAN

I.1 Rear Panel Connections

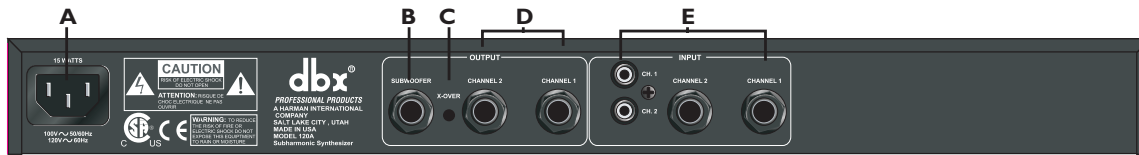
**A- IEC Power Cord Receptacle**

This is the power cord receptacle of the 120A. An IEC cord is included with the shipped product.

B- Subwoofer Output Connector

This output connector sends signal to your subwoofer amplifier, the low bass signal which ranges from 20 Hz up to the crossover frequency (80Hz to 120Hz). Nominal output signal level is +4dBu into 600Ω, and typical maximum output level is +22dBu into 600Ω. This output is an impedance-balanced output.

C- Crossover Selector Switch

This switch is used to engage the crossover function.

D- Output Connectors

The output section of the 120A offers impedance balanced/unbalanced 1/4" connections with a nominal output signal level at +4dBu into 600Ω, and typical maximum output level is +22dBu into 600Ω.

E- Input Connectors

The input section of the 120A offers electronically balanced/unbalanced 1/4" connections with a nominal input level of +4dBu and clipping level is at +22dBu into 600Ω. The 120A also offers RCA input connectors with a nominal input level of -10dBV and clipping at +8dBV.

I.2 Front Panel Controls

**F- Power LED**

This red LED indicates that power has been applied to the 120A.

G- Synthesis Bypass

Pressing the SYNTHESIS BYPASS will engage (when lit) or bypass the Synthesis effect of the 120A.

H- Crossover Select

This button is used to select the desired crossover frequency of the 120A. When pressed and lit, the 120Hz crossover frequency is engaged. Otherwise, the 80Hz frequency is used.

I- Crossover LED

This green LED (when lit) indicates that the active crossover has been selected. In this case, the mains outputs (channel 1 and channel 2) contain only the high-frequency portion of the signal, while the low-frequency portion appears at the mono Subwoofer output.

J- Subwoofer Level Control

This control sets the level of the low frequency crossover signal (original program plus synthesized harmonics) coming out of the SUBWOOFER jack.

K- LF Boost Control

This control is used to even out the total apparent Bass output of the 120A. Use the LF Boost to gently boost the bass on each channel (after the harmonics are summed in) to fill in the gap between the synthesized low bass (below 55 Hz) and the mid-bass of the original program. Always be careful of using excessive boost, especially if the Subharmonics control is past its midpoint, or if you are using a speaker equalizer, or any other bass tone control.

LF BOOST can be used with or without Subharmonic Synthesis.

L- Subharmonics Control

This control, along with the individual frequency controls, sets the amount of synthesized bass that the 120A adds to the program. Its affect depends not only on where it is set between MIN and MAX, but also on how much bass is present in the original signal to be augmented. Note that the effect will be most apparent in systems with subwoofers or other speakers that effectively reproduce very low bass tones.

M- 24Hz-36Hz and 36Hz-56Hz Level Controls

These controls individually let you customize the amount of the respective synthesized frequencies to be added in, tuning the ultimate bass response of your system to taste. For example, if the sound is too woofy or growly, try turning down the 36Hz-56Hz level. If your woofers are bottoming out (making a ticking, popping sound), or fuses are blowing, or your amp is clipping, try turning down the 24Hz-36Hz level. You may find that a setting produces fine results in one room, but produces too much boominess in another. If this occurs, adjust the controls as needed, (e.g., increase one or the other of the band levels). Experimentation will pay off with smooth, full, deeply extended bass. Remember, you are not selecting a frequency. You are controlling the overall level of each band.

1.3 Operating Notes

Setting Levels

Do not use the 120A at its extreme settings with loud volume levels, especially with digitally-produced audio.

Very low bass frequencies call for considerable amplifier power and for loudspeakers that can take this considerable power. However, the 120A not only can boost the bass that is present in the original program, but can simultaneously generate sizable amounts of new bass at even lower frequencies. If not used with care, the 120A can damage system components (e.g. woofers can be readily damaged by very loud bass, intentional or otherwise). dbx Professional Products cannot take responsibility for any damage to the amplifier, loudspeakers, or other stereo components that results from the 120A.

When using the 120A (or any other component in your system), reduce the system's output level. It is also recommended that all of the 120A front panel controls be set to fully counter-clockwise to minimum (MIN). When installation is complete, carefully return the system to normal listening levels and adjust the 120A to taste.

If clipping occurs, lower the volume and decrease the 120A settings. Note: Never try to reproduce non-musical sounds like artillery explosions or gunfire with the 120A.

Avoiding Transients

Any sharp noises from your sound system can be hard on your system, and since the 120A amplifies and augments all low-frequency information, extra caution is called for at all times. To be safe, turn the power amp on last, and off first, and always keep the main volume control low or off when turning the system or any of its components on.

To further reduce the chance of dangerous transients, make sure your system is operating at its optimum performance. We recommend you have all switches, buttons and knobs on your equipment cleaned by a qualified person (especially if any rasp or crackle is present). If you are using a turntable, check to make sure that the cueing is gentle.

Speaker Placement

For systems with multiple speakers, we recommend placing each speaker so that the distances from the center of its woofer to the three nearest boundaries are as different as possible. These distances are measured along the speaker cabinet sides, not in a straight line. When these distances are the same, the bass response of most speakers is roughest, with peaks and dips more than 10dB apart over just a few notes. Putting a conventional box-shaped speaker woofer down in a corner will make it sound very bassy, but for the evenness of bass, it's the worst spot available.

The formula for calculating maximum different distances a , b , and c and least bumpy speaker placement is: $a/b = b/c$, or $b^2 = ac$, where a , b , and c are never equal.

The same acoustic laws apply to your listening position: the smoothest bass will result when the distances from your head to the three nearest boundaries are as different as possible. In the same manner, the boomiest rooms have all three dimensions the same and the smoothest have them maximally different.

If you do reposition your speakers, you should also reset any output level controls on the back of the speaker cabinet. Many speakers offer a slight HF or MF boost with these controls all the way up, and the new increase in bass might be better balanced by such a maximum setting.

The 120A is not intended only as a device to create wall crumbling low-end. Judicious use with a pair of full range speakers can create the sense that a pair of speakers with 15" woofers is being used. An additional benefit of improving the sound of smaller speakers is that a pair of smaller speakers and a 120A is more portable than a pair of two larger speakers.

Turntable Feedback and Low Frequency Rumble

If you are using the 120A with a turntable, the increased levels of bass may make your turntable system more susceptible to feedback, wherein the turntable base, platter, cartridge/stylus, and/or the disc itself actually pickup and replay bass from the speakers. One symptom is an increasing, flapping rumble as you turn the volume up (severely, the system begins to howl) that disappears or is markedly reduced when the tonearm is lifted off the record. The cure is to isolate the turntable, making it immune to low-frequency vibrations. Any LF rumble in the system from turntable, air conditioning, through mics, etc., will be boosted by the 120A.

To reduce turntable feedback, begin by locating the turntable and the speakers as far apart as practical. Next, short of replacing the turntable, since some turntables are much more prone to feedback than others, shock-absorber feet designed specifically for this problem. A massive base or table under the turntable may decouple it from the cases.

Note for CD Players: High levels of Bass can cause CD players to skip. It is a good idea to locate CD players away from low-end drivers and loudspeakers, and shock mount them.

I.4 Connecting the 120A to Your System

Basic Connection

The 120A can be used with any line-level device. For more specific cabling information, refer to the Cable diagram on page 7.

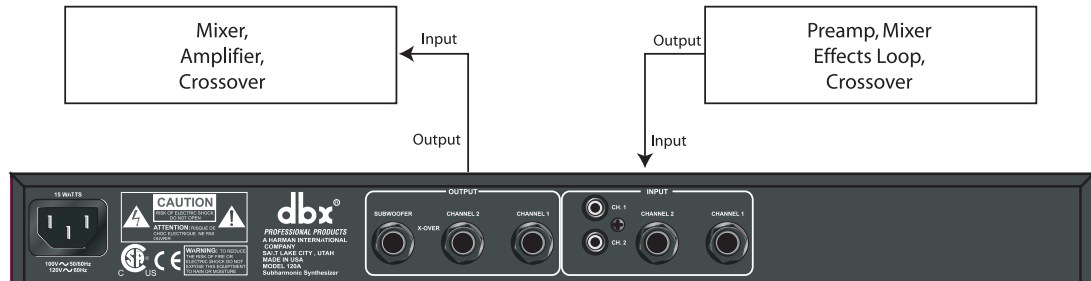

1. Turn off all equipment before making any connections.
2. Mount the 120A in a 1U Rack Space (optional)

The 120A requires one rack space. It can be mounted above or below anything that doesn't generate excessive heat, since it requires no special ventilation. Ambient temperatures should not exceed 113⁰ F (45⁰ C) when equipment is powered.

Note: Avoid over-tightening of rackmounting screws as this could damage the front panel.

Caution: Never remove the cover. there are no user-serviceable parts inside, and you run the risk of an electric shock.
3. Make connections via 1/4" phone jacks or RCA jacks according to your requirements.

Subwoofer Operation: Set the CROSSOVER switch to CROSSOVER/FULL RANGE mode and connect the amplification for the main speakers to the CHANNEL 1, CHANNEL 2 outputs. In addition, connect the Subwoofer to the Subwoofer Output Jack.

Operation without a Subwoofer: Set the CROSSOVER switch to FULL RANGE and connect the amplification for the main speakers to CHANNEL 1 and CHANNEL 2 Output.

Typical patch points include: a mixer's channel or subgroup inserts when using the 120A on individual instruments or tracks; the mixer's main outputs when mixing an instrument preamps's effects loop when using the 120A for guitar or bass; main outs of a submixer as the signal is sent to main mixer. The 120A can be used either before or after an external electronic crossover. When using a chain of processors, the 120A should generally be placed as far down the chain as possible. We recommend you use common sense and experiment with different setups to see which one provides the best results for your needs.

4. Plug in the AC power cable to power On the unit.

Note: Check the line voltage. The 120A is shipped for 115V or 230V, 50Hz or 60Hz operation. Refer to the unit's rear panel to verify your unit's precise line voltage.

Appendix

A.1 Block diagram

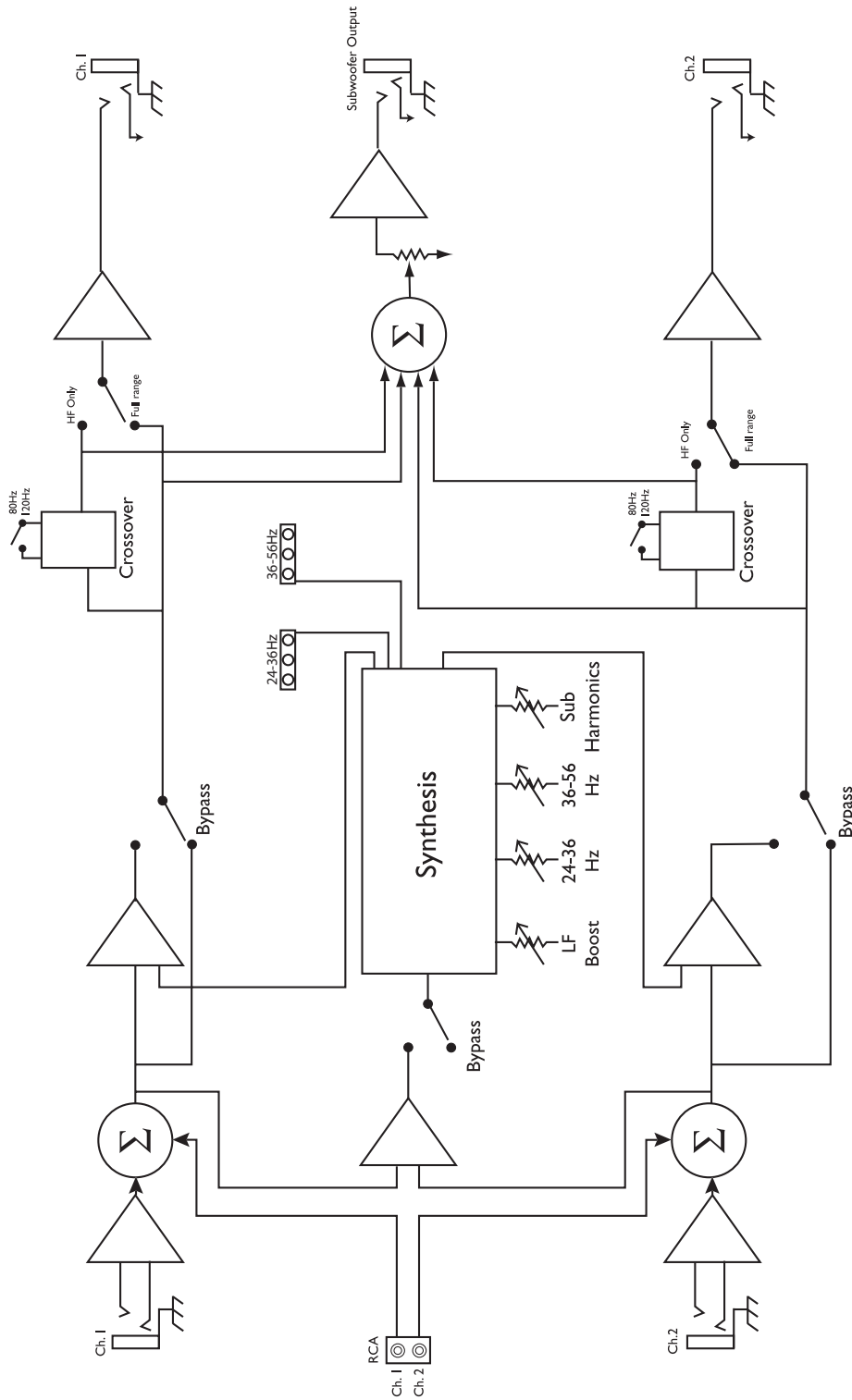

A.2 Specifications

Frequency Response:	20Hz-20kHz ± 0.5 dB, (no synthesis, full-range mode) 15Hz-90kHz +0, -3dB
Input Impedance:	$\geq 40k\Omega$ Balanced or $20k\Omega$ unbalanced (1/4") $20k\Omega$ (RCA)
Maximum Input Level:	+22dBu (1/4") +8.5dBV (RCA)
Output Impedance:	100Ω , Impedance balanced
Maximum Output Level:	+22dBu into 600Ω
Connector Type:	1/4" TRS Jacks (Inputs and Outputs) RCA (Inputs)
THD:	0.05% (no synthesis, either output)
Output noise:	-88dBu, controls@max., 22Hz > 22kHz unweighted (full range output)
Front Panel Controls:	26-36Hz and 36-56Hz Band Synthesis Level, Subharmonics, Low Frequency Boost, Subwoofer Output Crossover Frequency, Select, Crossover in/out
Indicators:	Power, Crossover, Bypass
Metering:	Synthesis activity (3 LEDs per band)
Dynamic Range:	112dB
Synthesis Frequency Range:	26-56Hz (from 54-110Hz input signal)
Crossover:	12dB/octave high pass (-3dB @ 80 Hz or 120Hz); 6dB/octave derived low pass. Phase-coherent (unity-sum)
Power Requirements:	100-120VAC; 50/60Hz D0 Version, 220-240VAC; 50/60Hz EU Version
Dimensions:	1.75"x19"x6.2" (4.5cm x 48.3cm x 15.75cm)
Rack Space:	1 Rack Unit
Weight: Net/Shipping:	4.75 lbs/8 lbs, 2.2kg/3.7kg

A.3 Installation Considerations and Wiring Diagrams

The 120A has 1/4", balanced/unbalanced inputs and is designed for nominal +4dBu levels. The 120A also offers RCA connectors, and is designed for nominal -10dBV levels.

Input Cable Configurations

The 120A will accept either balanced or unbalanced sources as long as cables are wired according to the following diagrams. In an emergency, 1/4" mono cables will work. Connect the sleeve to the cable's shield. Note: for maximum hum rejection with a balanced source, avoid common grounding at the 120A's input and output. The best starting point is to ground the shield of the input cable at the source device (leaving it unconnected at the 120A).

Output Cable Configurations

The 120A will drive either balanced or unbalanced loads as long as the cables are wired according to the following figures. The output's impedance at 100Ω, allowing operation with virtually any load. Nominal operating level is +4dBu into 600Ω. If using 1/4" mono plugs, at the output, the 120A will be grounded to the load device. This can cause a ground loop. By using 1/4" balanced phone plugs, the grounds of both the 120A and the load can be isolated to reduce hum. Leave the shield unconnected at the load device.

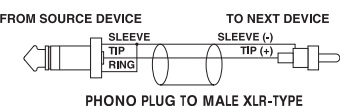
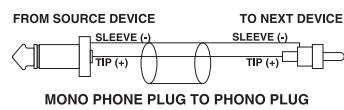
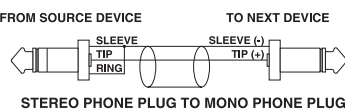
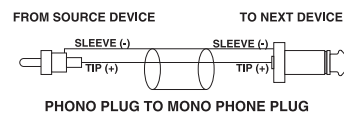
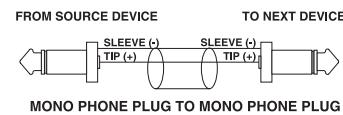
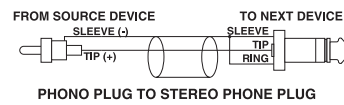
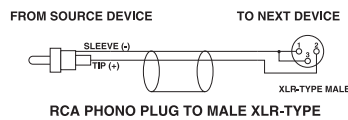
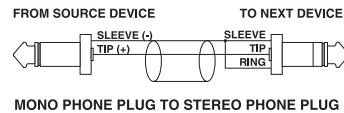
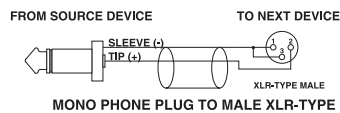
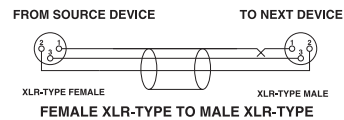
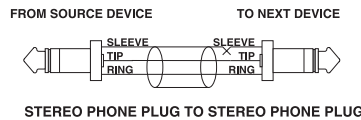
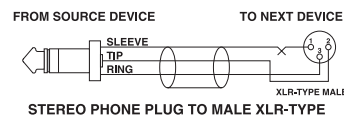
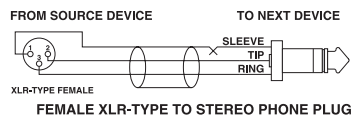



8760 South Sandy Pkwy.

Sandy, Utah 84070

Phone: (801) 568-7660

Fax: (801) 568-7662

Questions or comments?

Email us at: support@dbxpro.com

or visit our Website at:

www.dbxpro.com