

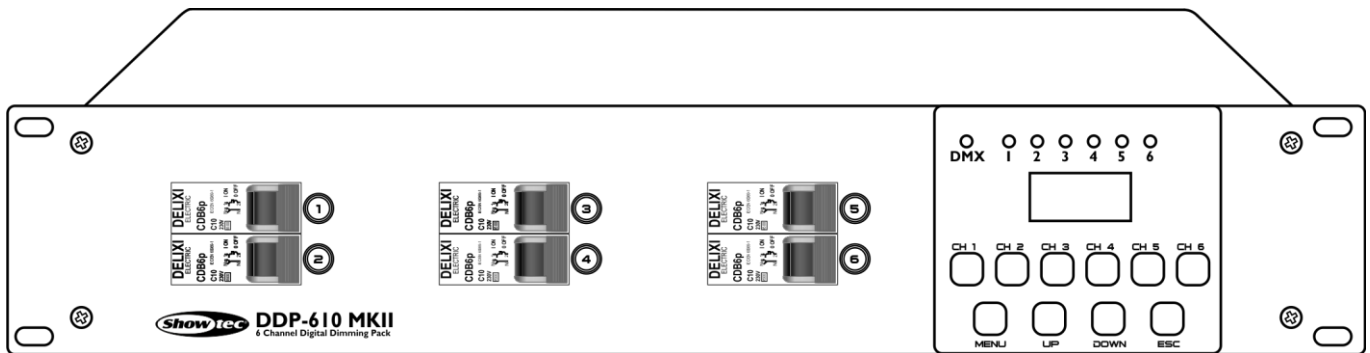

MANUAL



ENGLISH

DDP-610 MKII

V1

Ordercode: 50754/50755/50757

Table of contents

Warning	2
Safety Instructions	2
Operating Determinations	4
Connection with the Single-Phase Power Network	4
Connection with the Three-Phase Power Network	4
Return Procedure	5
Claims.....	5
Description of the device	6
Frontside.....	6
Backside DDP-610M (ordercode 50754)	7
Backside DDP-610S (ordercode 50755)	7
Backside DDP-610T (ordercode 50757)	8
Installation	8
Pin assignment DDP-610M (ordercode 50754).....	8
Terminal connections DDP-610T (ordercode 50757).....	9
Occupation of the XLR connection (All versions)	9
Occupation of the analog connector (DDP-610S ordercode 50755/DDP-610T	9
ordercode 50757)	9
Set Up and Operation	10
Switching power to the DDP-610 MKII.....	10
Manual channel output adjustment.....	10
Menu Overview	11
Main Menu Options	12
1. Patching mode	12
2. Dimming curve.....	13
3. Minimum output level.....	14
4. Maximum output level.....	14
5. DMX failure settings	15
Maintenance	15
Troubleshooting	16
Product Specifications	16
Dimensions	17
Notes	18

Warning



**For your own safety, please read this user manual carefully
before your initial start-up!**



Unpacking Instructions

Immediately upon receiving this product, carefully unpack the carton and check the contents to ensure that all parts are present, and have been received in good condition. Notify the dealer immediately and retain packing material for inspection if any parts appear damaged from shipping or the carton itself shows signs of mishandling. Save the carton and all packing materials. In the event that a fixture must be returned to the factory, it is important that the fixture be returned in the original factory box and packing.

Your shipment includes:

- Showtec DDP-610 MKII
- User manual

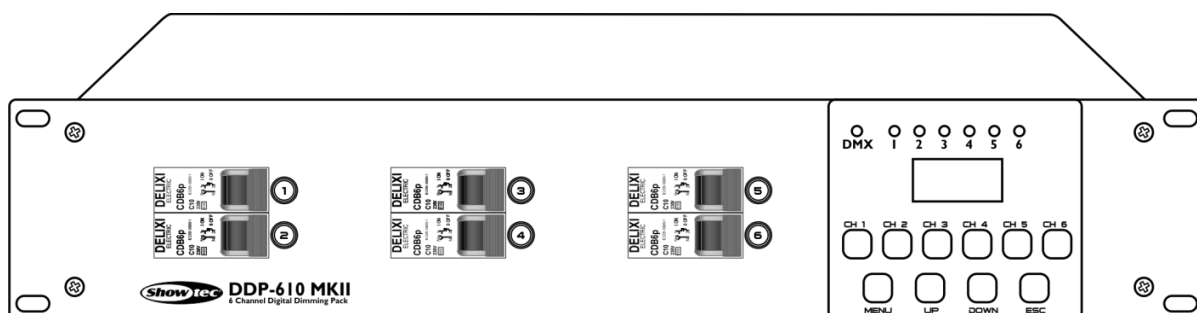

CAUTION!

**Keep this device away from rain and moisture!
Unplug mains lead before opening the housing!**



Safety Instructions

Every person involved with the installation, operation and maintenance of this device has to:

- be qualified
- follow the instructions of this manual



**CAUTION! Be careful with your operations.
With a dangerous voltage you can suffer
a dangerous electric shock when touching the wires!**



Before your initial start-up, please make sure that there is no damage caused by transportation. Should there be any, consult your dealer and do not use the device.

To maintain perfect condition and to ensure a safe operation, it is absolutely necessary for the user to follow the safety instructions and warning notes written in this manual.

Please consider that damages caused by manual modifications to the device are not subject to warranty.

This device contains no user-serviceable parts. Refer servicing to qualified technicians only.

IMPORTANT!

The manufacturer will not accept liability for any resulting damages caused by the non-observance of this manual or any unauthorized modification to the device.

- Never let the power cord come into contact with other cables! Handle the power cord and all connections with the mains with particular caution!
- Never remove warning or informative labels from the unit.
- Do not insert objects into air vents.
- Do not open the device and do not modify the device.
- Do not connect this device to another dimmerpack.
- Do not switch the device on and off in short intervals, as this would reduce the system's life.
- Only use device indoor, avoid contact with water or other liquids.
- Avoid flames and do not put close to flammable liquids or gases.
- Always disconnect power from the mains, when device is not used or before cleaning! Only handle the power cord by the plug. Never pull out the plug by tugging the power cord.
- Make sure that the available voltage is not higher than stated on the rear panel.
- Make sure that the power cord is never crimped or damaged. Check the device and the power cord from time to time.
- If device is dropped or struck, disconnect mains power supply immediately. Have a qualified engineer inspect for safety before operating.
- If the device has been exposed to drastic temperature fluctuation (e.g. after transportation), do not switch it on immediately. The arising condensation water might damage your device. Leave the device switched off until it has reached room temperature.
- If your Showtec device fails to work properly, discontinue use immediately. Pack the unit securely (preferably in the original packing material), and return it to your Showtec dealer for service.
- For replacement use fuses of same type and rating only.
- This device falls under protection class I. Therefore it is essential to connect the yellow/green conductor to earth.
- Repairs, servicing and electric connection must be carried out by a qualified technician.
- **WARRANTY:** Till one year after date of purchase.

Operating Determinations

- This device is not designed for permanent operation. Consistent operation breaks will ensure that the device will serve you for a long time without defects.
- The maximum ambient temperature $t_a = 40^\circ\text{C}$ must never be exceeded.
- The relative humidity must not exceed 50 % with an ambient temperature of 40°C .
- If this device is operated in any other way, than the one described in this manual, the product may suffer damages and the warranty becomes void.
- Any other operation may lead to dangers like short-circuit, burns, electric shock, crash etc.

You endanger your own safety and the safety of others!

Connection with the Single-Phase Power Network

Connect the device to the mains with the power-plug.

Always make sure, that the right color cable is connected to the right place.

International	EU Cable	UK Cable	US Cable	Pin
L	BROWN	RED	YELLOW/COPPER	PHASE
N	BLUE	BLACK	SILVER	NEUTRAL
	YELLOW/GREEN	GREEN	GREEN	PROTECTIVE GROUND

Connection with the Three-Phase Power Network

Connect the device to the 3-phase Power Socket with a CEE-form power-plug.

Always make sure that the right color cable is connected to the right place.

International	EU Cable	UK Cable	US Cable	Pin
L1	BROWN	RED	BLACK	PHASE 1
L2	BLACK	YELLOW	RED	PHASE 2
L3	GREY	BLUE	BLUE	PHASE 3
N	BLUE	BLACK	WHITE	NEUTRAL
	YELLOW/GREEN	GREEN	GREEN	PROTECTIVE GROUND

Make sure that the device is always connected properly to the earth!

Improper installation can cause serious injuries to people and/or damage of property !

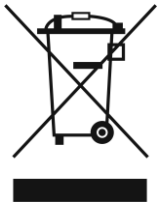

Return Procedure



Returned merchandise must be sent prepaid and in the original packing, call tags will not be issued. Package must be clearly labeled with a Return Authorization Number (RMA number). Products returned without an RMA number will be refused. Highlite will not accept the returned goods or any responsibility. Call Highlite 0031-455667723 or mail aftersales@highlite.nl and request an RMA prior to shipping the fixture. Be prepared to provide the model number, serial number and a brief description of the cause for the return. Be sure to properly pack fixture, any shipping damage resulting from inadequate packaging is the customer's responsibility. Highlite reserves the right to use its own discretion to repair or replace product(s). As a suggestion, proper UPS packing or double-boxing is always a safe method to use.

Note: If you are given an RMA number, please include the following information on a piece of paper inside the box:

- 01) Your name
- 02) Your address
- 03) Your phone number
- 04) A brief description of the symptoms

Claims

The client has the obligation to check the delivered goods immediately upon delivery for any shortcomings and/or visible defects, or perform this check after our announcement that the goods are at their disposal. Damage incurred in shipping is the responsibility of the shipper; therefore the damage must be reported to the carrier upon receipt of merchandise.

It is the customer's responsibility to notify and submit claims with the shipper in the event that a fixture is damaged due to shipping. Transportation damage has to be reported to us within one day after receipt of the delivery.

Any return shipment has to be made post-paid at all times. Return shipments must be accompanied with a letter defining the reason for return shipment. Non-prepaid return shipments will be refused, unless otherwise agreed in writing.

Complaints against us must be made known in writing or by fax within 10 working days after receipt of the invoice. After this period complaints will not be handled anymore.

Complaints will only then be considered if the client has so far complied with all parts of the agreement, regardless of the agreement of which the obligation is resulting.

Description of the device

Features

The Showtec DDP-610 MKII is a dimmer pack which combines all features of the most common dimmer packs. It has 6 channels which can handle a maximum load of 10A each. Each channel is completely patchable and it is possible to set a separate dimming curve for each of them. The DDP-610 MKII has a built-in DMX failure system, ensuring that there will always be light, when your DMX signal fails. For stand-alone operation the DDP-610 MKII has several built-in chase programs.

- Automatic silent fan which will be activated by a temperature above 40°C.
- Input voltage: 230VAC, 50/60Hz single phase connection, 400VAC, 50/60Hz 3-phase connection
- Single/3-phase operation
- Control: DMX-512
- Output power: 10A/per channel; total: 60A
- Circuit breakers: 16A
- Built-in chase programs for stand-alone operation
- DMX failure with back up CUE system
- Analog input: 0-10V
- Patchable per channel
- LCD display for easy setup
- Temperature, overload and short circuit protection
- Connections DDP-610M (50754): 3-pin XLR IN/OUT, 16-pole Multipin
- Connections DDP-610S (50755): 3-pin XLR IN/OUT, 8-pin analog DIN connectors, 6x Schuko
- Connections DDP-610T (50757): Terminal screw connectors, 3-pin XLR IN/OUT, 8-pin analog DIN connectors
- Dimensions: 483 x 380 x 88 mm (LxWxH)
19 inch x 2HE (LxH)
- Weight: 12 kg

Frontside

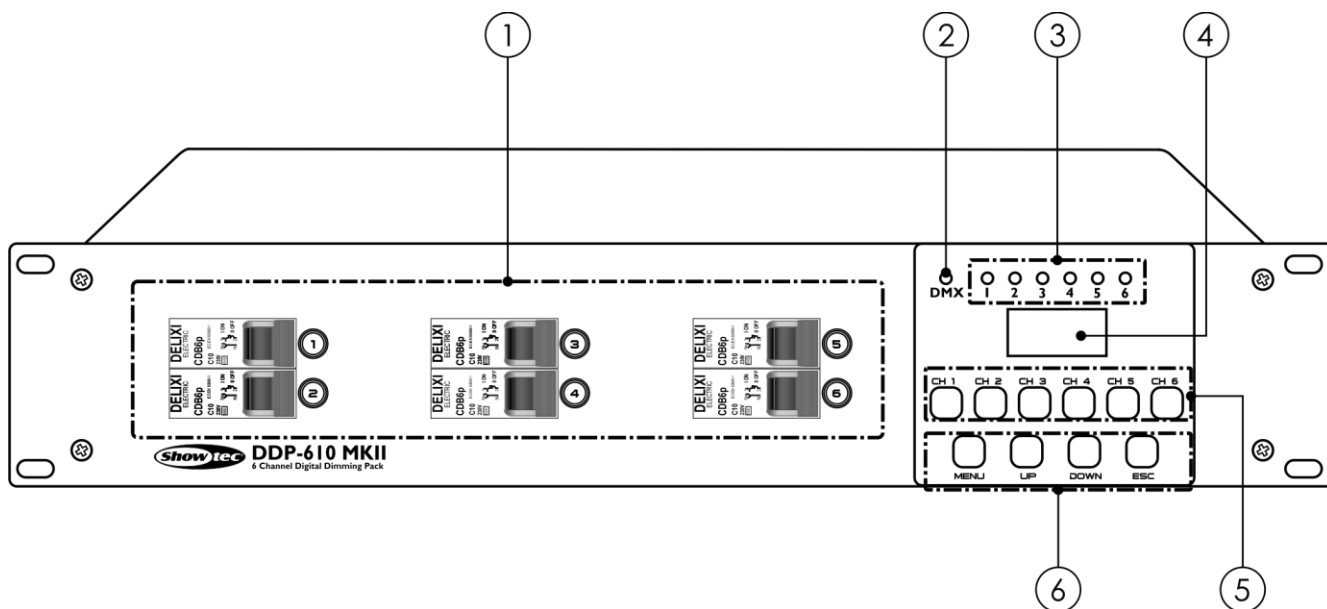

Fig.01

- 01) **Circuit breakers (CH1-CH6)**
- 02) **DMX LED indicator**
This LED indicates if the device receives a DMX signal.
- 03) **Channel LED indicator**
The LED intensity indicates the corresponding channel's output value.
- 04) **LCD display**
- 05) **Channel buttons (CH1-CH6)**
- 06) **Menu buttons (MENU, UP, DOWN, ESC)**

Backside DDP-610M (ordercode 50754)

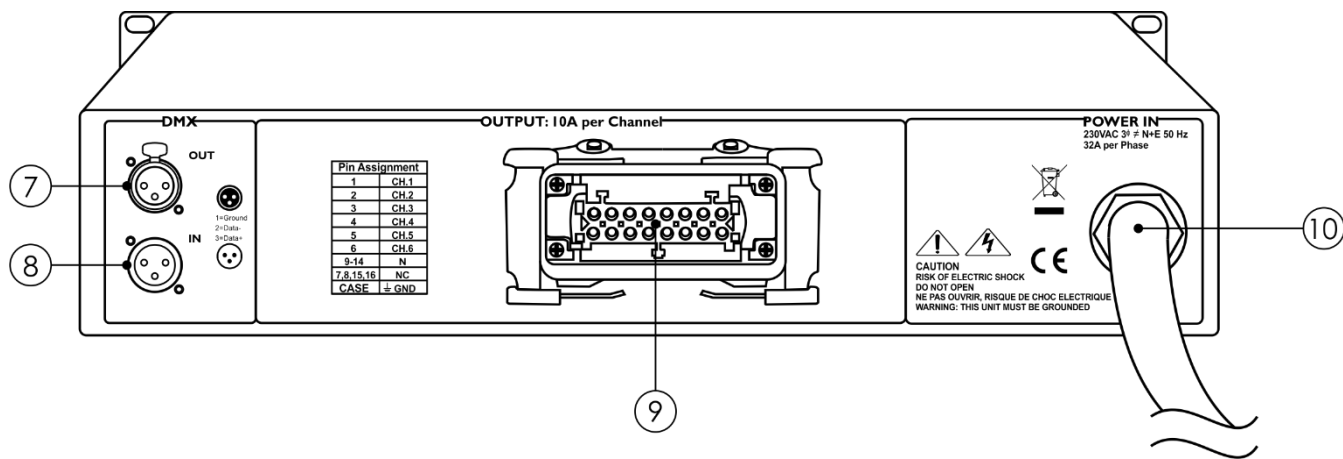

Fig. 02

- 07) **3-pin DMX signal connector OUT**
- 08) **3-pin DMX signal connector IN**
- 09) **Multiconnector output (6 outputs)**
Maximum load 10A per output.
- 10) **Power input**
Total load should not exceed 32A per phase.

Backside DDP-610S (ordercode 50755)

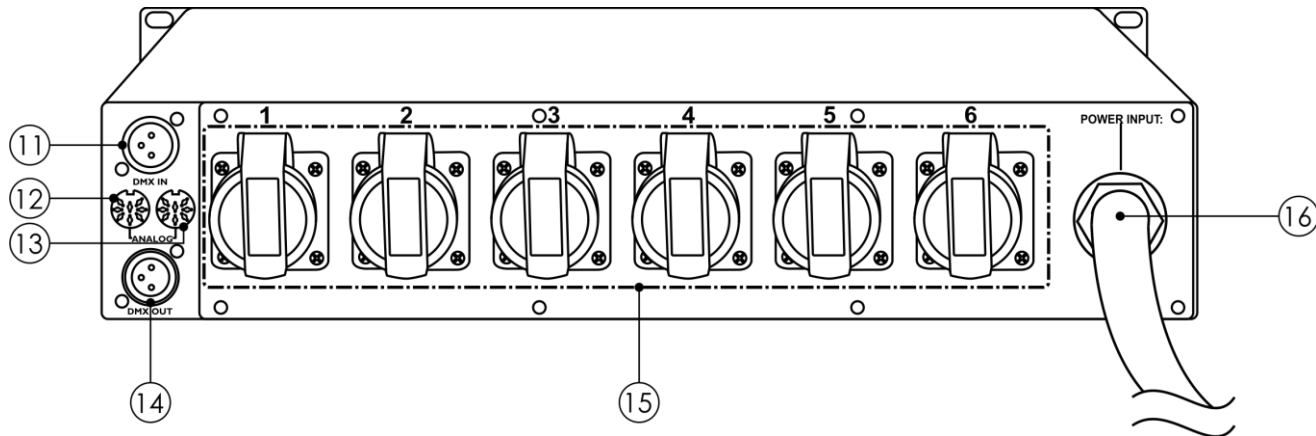

Fig. 03

- 11) **3-pin DMX signal connector IN**
- 12) **Analog IN 1-6 connector**
This connector allows you to control each channel with an analog DC voltage between 0-10V.
- 13) **Analog through 1-6 connector**
This connector is wired parallel with the analog input 1-6 connector (12).
- 14) **3-pin DMX signal connector OUT**
- 15) **6x Schuko output**
Maximum load 10A per output.
- 16) **Schuko Power cable**

Backside DDP-610T (ordercode 50757)

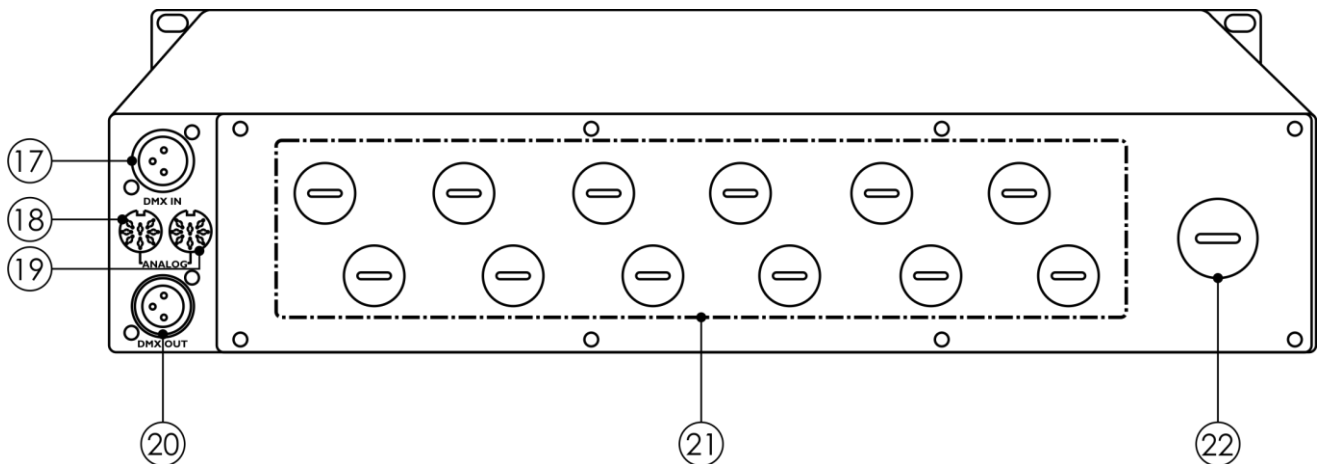

Fig. 04

- 17) **3-pin DMX signal connector IN**
- 18) **Analog IN 1-6 connector**
This connector allows you to control each channel with an analog DC voltage between 0-10V.
- 19) **Analog through 1-6 connector**
This connector is wired parallel with the analog input 1-6 connector (18).
- 20) **3-pin DMX signal connector OUT**
- 21) **Cable entrances**
Make sure that you use good quality cables and cable glands.
- 22) **Power cable entrance**
Make sure that you use good quality cables and cable glands.

Installation

Remove all packing materials from the DDP-610 MKII. Check if all foam and plastic padding is removed. Screw the equipment into a 19-inch rack. On each side of the device a metal plate is attached which also can be used to fasten to the 19-inch rack. Let all wiring to and from the DDP-610 MKII be carried out by a qualified technician.

Pin assignment DDP-610M (ordercode 50754)

Pin Assignment	
1	CH.1
2	CH.2
3	CH.3
4	CH.4
5	CH.5
6	CH.6
9-14	N
7,8,15,16	NC
CASE	⏚ GND

Always disconnect from electric mains power supply before cleaning or servicing. Damages caused by non-observance are not subject to warranty.

Terminal connections DDP-610T (ordercode 50757)

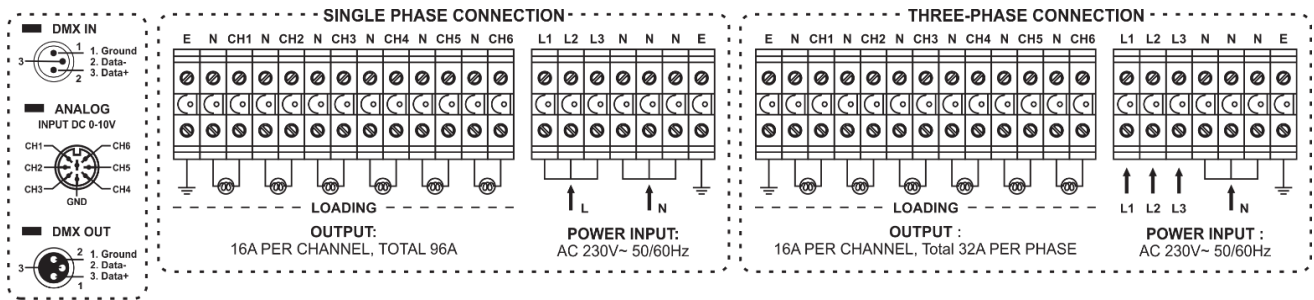

Always disconnect from electric mains power supply before cleaning or servicing.
 Damages caused by non-observance are not subject to warranty.

Occupation of the XLR connection (All versions)

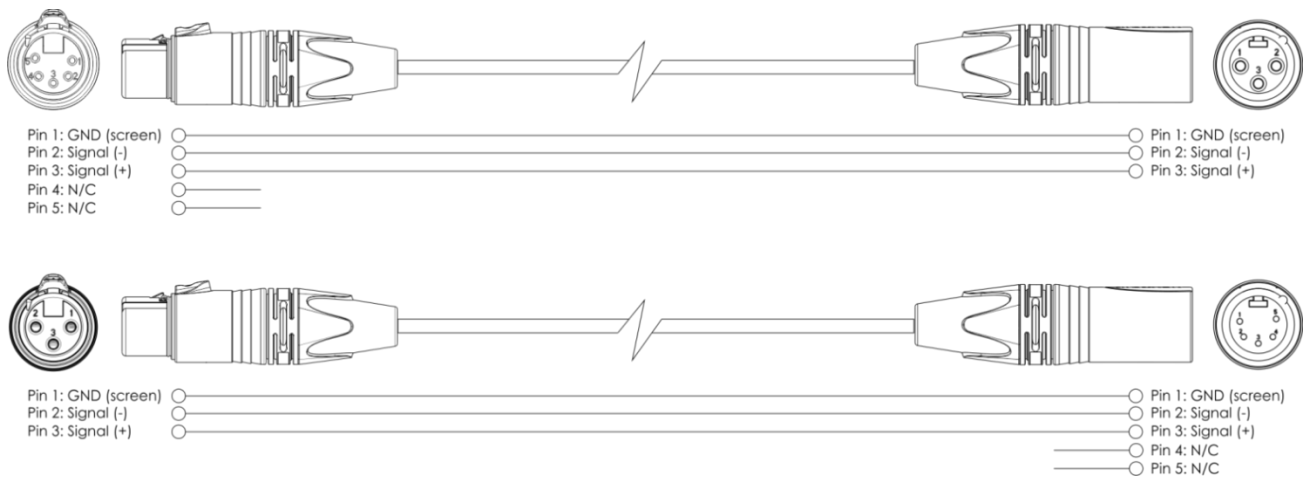

Occupation of the analog connector (DDP-610S ordercode 50755/DDP-610T ordercode 50757)

INPUT DC 0-10V



Set Up and Operation

Follow the directions below, as they pertain to your preferred operation mode.

Before plugging the unit in, always make sure that the power supply matches the product specification voltage. Do not attempt to operate a 120V specification product on 230V power, or vice versa. Connect the device to the main power supply.

Switching power to the DDP-610 MKII

Showtec
Rev1.00

- 01) When powering the unit on, the starting screen will pop up. The display shows
- 02) After approximately 5 seconds, the starting menu will appear:

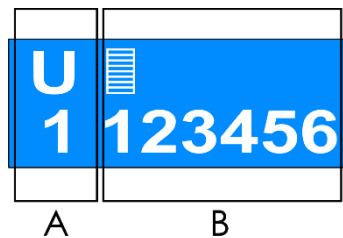

- 03) **A** – shows the actual channel which you are editing or the last edited channel. The output of the channel is indicated by a bar graph.
- 04) **B** – overview of all channels. The output of each channel is indicated by a bar graph.

Manual channel output adjustment

- 01) While in the main menu, press the **CH1-CH6** buttons to choose the channel which you want to edit.
- 02) Press the **ESC** button to activate the channel output increase mode.
- 03) Press and hold down the **CH1-CH6** button corresponding to the desired channel and observe how the output value increases.
- 04) Press the **ESC** button again to activate the channel output decrease mode.
- 05) Press and hold down the **CH1-CH6** button corresponding to the desired channel and observe how the output value decreases.
- 06) Press the **MENU** button to open the main menu, in order to change settings.

Menu Overview

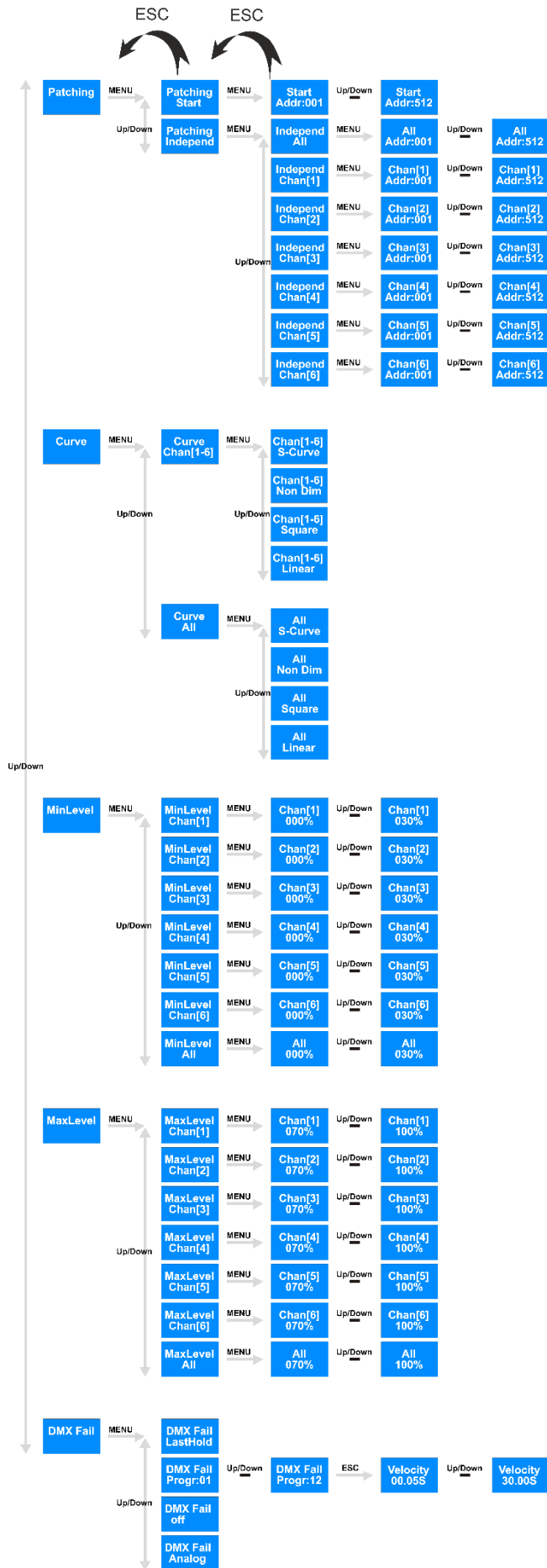

Main Menu Options

- Patching** Patching mode
- Curve** Dimming curve
- MinLevel** Minimum output level
- MaxLevel** Maximum output level
- DMX Fail** DMX failure settings

1. Patching mode

With this menu you can set whether the DMX address is applied to all channels or just one channel at a time.

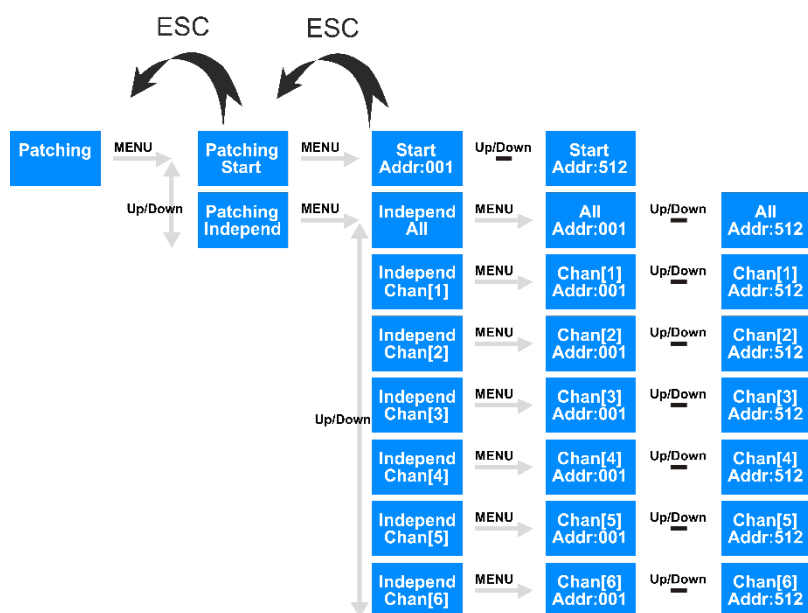

- 01) While in the main menu, press the **UP/DOWN** buttons until the display shows **Patching**.
- 02) Press the **MENU** button to open the submenu.
- 03) Press the **UP/DOWN** buttons to toggle between the following options:

Patching Start One starting DMX address for all channels.

Patching Independ Set individual DMX addresses for each of the 6 available channels.

- 04) When the display shows **Patching Start**, press the **MENU** button to proceed to the settings.
- 05) Press the **UP/DOWN** buttons to set the starting address for all 6 channels. The adjustment range is between 001-512.
- 06) When the display shows **Patching Independ**, press the **MENU** button to proceed to the settings.
- 07) Press the **UP/DOWN** buttons to choose the channel you would like to adjust.
- 08) Press the **MENU** button to proceed to set the DMX address.

- 09) Press the **UP/DOWN** buttons to assign a separate address to each of the 6 channels. The adjustment range is between 001-512.
- 10) Once you have adjusted all the settings, press the **ESC** button to return to the previous menu.

2. Dimming curve

With this menu you can set the desired dimming curve.

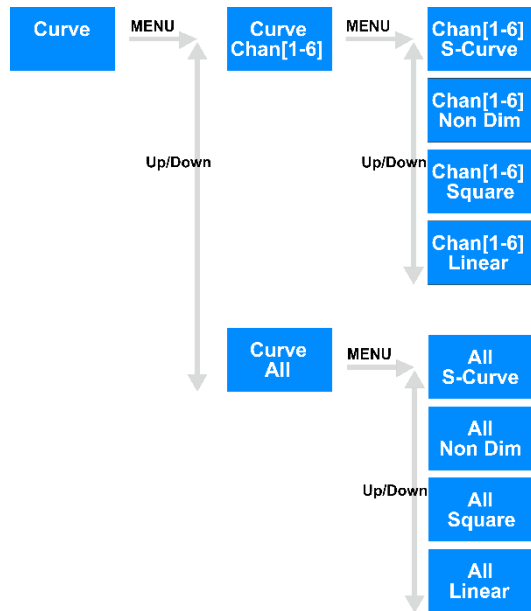

- 01) While in the main menu, press the **UP/DOWN** buttons until the display shows Curve.
- 02) Press the **MENU** button to enter the submenu.
- 03) Press the **UP/DOWN** buttons to toggle between the following options:

Curve Chan[1-6] Set individual dimming curves for each of the 6 available channels

Curve All One dimming curve for all channels.

- 04) When the display shows Curve Chan[1-6], press the **MENU** button to proceed to the dimming curve choice menu.
- 05) Press the **UP/DOWN** buttons to choose one of the 4 available dimming curves and assign it to the desired channel:
 - S-curve
 - Non Dim (ON/OFF) curve
 - Square curve
 - Linear curve
- 06) When the display shows Curve All, press the **MENU** button to proceed to the dimming curve choice menu.
- 07) Press the **UP/DOWN** buttons to choose one of the 4 available dimming curves and assign it to all 6 channels:
 - S-curve
 - Non Dim (ON/OFF) curve
 - Square curve
 - Linear curve
- 08) Once you have adjusted all the settings, press the **ESC** button to return to the previous menu.

3. Minimum output level

With this menu you can set the minimum output level and set whether the output is applied to all channels or just one channel at a time.

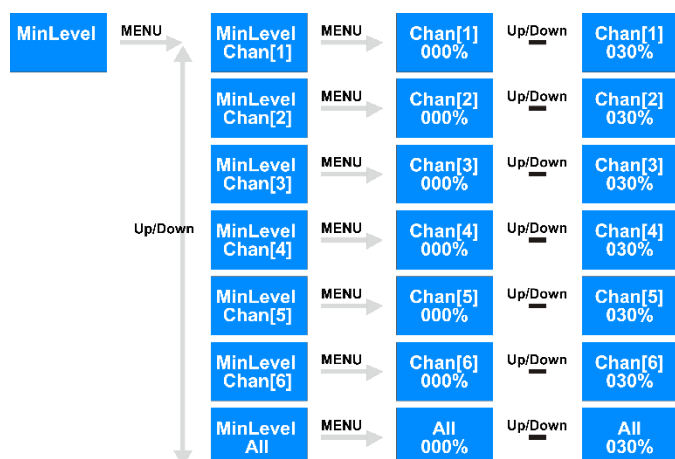

- 01) While in the main menu, press the **UP/DOWN** buttons until the display shows MinLevel.
- 02) Press the **MENU** button to enter the submenu.
- 03) Press the **UP/DOWN** buttons to choose one of the following options:
 - Chan(1)-Chan(6): the minimum output level is applied only to the desired channel
 - All: the minimum output level is applied to all 6 channels
- 04) Press the **MENU** button to proceed to the minimum output level settings.
- 05) Press the **UP/DOWN** buttons to increase/decrease the minimum output level. The adjustment range is between 0-30%.
- 06) Once you have adjusted all the settings, press the **ESC** button to return to the previous menu.

4. Maximum output level

With this menu you can set the maximum output level and set whether the output is applied to all channels or just one channel at a time.

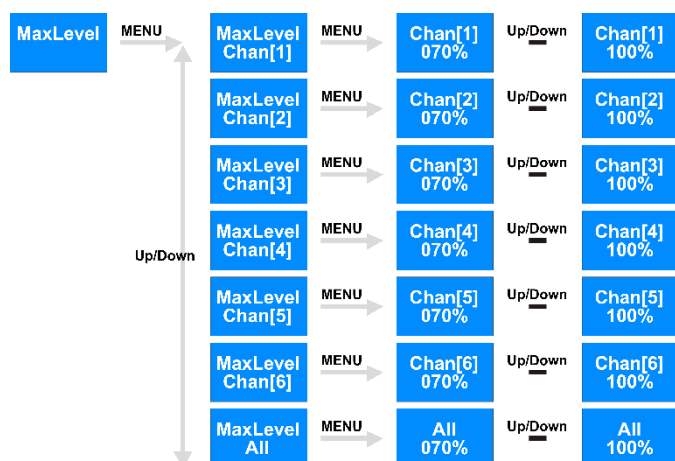

- 01) While in the main menu, press the **UP/DOWN** buttons until the display shows MaxLevel.
- 02) Press the **MENU** button to enter the submenu.
- 03) Press the **UP/DOWN** buttons to choose one of the following options:
 - Chan(1)-Chan(6): the maximum output level is applied only to the desired channel
 - All: the maximum output level is applied to all 6 channels
- 04) Press the **MENU** button to proceed to the maximum output level settings.
- 05) Press the **UP/DOWN** buttons to increase/decrease the maximum output level. The adjustment range is between 70-100%.
- 06) Once you have adjusted all the settings, press the **ESC** button to return to the previous menu.

5. DMX failure settings

With this menu you can determine the behavior of the DDP-610 MKII in case of DMX failure.

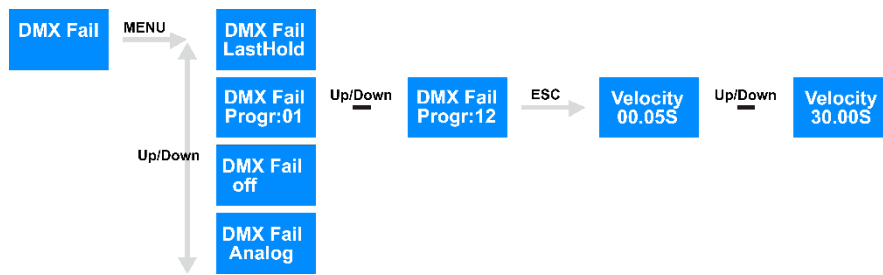

- 01) When in the main menu, press the **UP/DOWN** buttons until the display shows **DMX Fail**.
- 02) Press the **MENU** button to open the menu.
- 03) Press the **UP/DOWN** buttons to toggle between the following options:
 - Last Hold
 - Built-in programs (Progr:01 - Progr:12)
 - Off
 - Analog
- 04) When the display shows **DMX Fail LastHold**, the device will memorize the last successfully received DMX signal and will continue using it until DMX signal reception is restored.
- 05) When the display shows one of the 12 built-in programs **DMX Fail Progr:01**, press the **ESC** button to enter the program speed settings.
- 06) Press the **UP/DOWN** buttons to increase/decrease the program speed. The adjustment range is between **Velocity 00.05S** and **Velocity 30.00S**, from fast to slow.
- 07) When the display shows **DMX Fail off**, the device will blackout the output in case of DMX failure.
- 08) When the display shows **DMX Fail Analog**, the device will react to the connected analog signal source.
- 09) Once you have adjusted all the settings, press the **ESC** button to return to the previous menu.

Maintenance

The operator has to make sure that safety-related and machine-technical installations are to be inspected by an expert after every year in the course of an acceptance test.

The operator has to make sure that safety-related and machine-technical installations are to be inspected by a skilled person once a year.

We strongly advise you to let a qualified technician give the unit a maintenance check twice a year.

The following points have to be considered during the inspection:

- 01) All screws used for installing the device or parts of the device have to be tightly connected and must not be corroded.
- 02) There may not be any deformations on housings, fixations and installation spots.
- 03) The electric power supply cables must not show any damages or material fatigue.

The Showtec DDP-610 MKII requires almost no maintenance. However, you should keep the unit clean.

- 01) Disconnect the mains power supply, and then wipe the cover with a damp cloth. Do not immerse in liquid. Do not use alcohol or solvents.
- 02) Please clean internal components twice a year with a light brush and vacuum cleaner.
- 03) Keep connections clean. Disconnect electric power, and then wipe the connections with a damp cloth. Make sure connections are thoroughly dry before linking equipment or supplying electric power.
- 04) Check and tighten all screws, especially the screw terminals.
- 05) The electric power supply cables must not show any damages or material fatigue.

Troubleshooting

This troubleshooting guide is meant to help solve simple problems. If a problem occurs, carry out the steps below in sequence until a solution is found. Once the unit operates properly, do not carry out the following steps.

- 01) If the device does not operate properly, unplug the device.
- 02) Check power from the wall, all cables, the settings (return to default), etc.
- 03) Plug the unit in again.
- 04) If nothing happens after 30 seconds, unplug the device.
- 05) Return the device to your Showtec dealer.

Product Specifications

Model:	Showtec DDP-610 MKII
Power supply:	230VAC, 50/60Hz single phase connection, 400VAC, 50/60Hz 3-phase connection
Output power	10A per channel/max. 60A
Dimensions:	483 x 380 x 88 mm (LxWxH) 19 inch x 2HE (LxH)
Weight:	12 kg
Operation	
Signal pin OUT:	Pin 1 (earth), pin 2 (-), pin 3 (+)
Signal input:	3-pin DMX IN
Signal output:	3-pin DMX OUT
Electro-mechanical effects	
Control:	DMX-512
Circuit breaker:	3 x 2-pin 16A, C-Type
Housing:	Die-cast aluminum
Connections DDP-610M (50754):	3-pin XLR IN/OUT, 16-pole Multipin
Connections DDP-610S (50755):	3-pin XLR IN/OUT, 8-pin analog DIN connectors, 6x Schuko
Connections DDP-610T (50757):	Terminal screw connector, 3-pin XLR IN/OUT, analog 8-pin DIN connector
Colour:	Grey
Onboard:	LCD display for easy setup
Cooling:	Fan
IP rating:	IP20
Max. ambient temperature t_a :	40°C
Max. housing temperature t_B :	80°C

Design and product specifications are subject to change without prior notice.



Website: www.Showtec.info
Email: service@highlite.nl

Dimensions

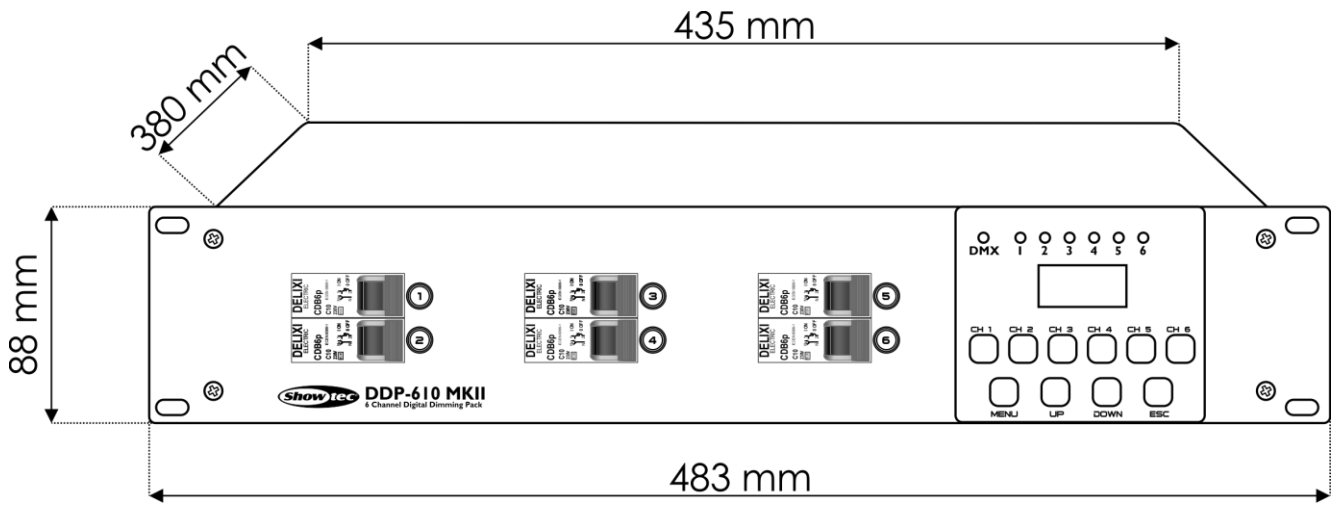



©2017 Showtec