

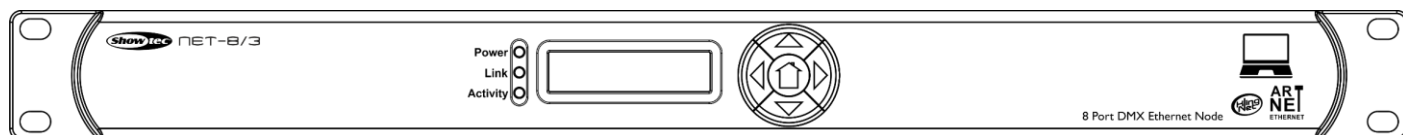

MANUAL



ENGLISH

Net-8/3

V1

Ordercode: 50809

Table of contents

Warning	2
Safety Instructions	2
Operating Determinations	4
Connection with the mains.....	4
Return Procedure.....	5
Claims.....	5
Description of the device	6
Frontside.....	6
Backside	7
Installation	7
Set Up and Operation	7
Control Modes.....	8
Setup Net-8/3 with Laptop/PC.....	8
Setup Net-8/3 with Lighting controller	9
Fixture Linking.....	10
Data Cabling.....	10
Control Panel.....	11
Status Menu	11
Main Menu Options	12
1. Rename	12
2. Set DHCP	12
3. Set IP Address	13
4. Set Netmask.....	13
5. Set DMX Port	13
6. Set Device ID	15
7. Set LCD Backlight	15
8. Set Display	15
9. User Preset	16
10. Set Default	16
11. Version	16
Maintenance	17
Replacing the Fuse.....	17
Troubleshooting	17
No Light.....	17
No Response to DMX.....	17
Product Specifications	19
Dimensions	20
Notes	21

Warning

**For your own safety, please read this user manual carefully
before your initial start-up!**

**Unpacking Instructions**

Immediately upon receiving this product, carefully unpack the carton and check the contents to ensure that all parts are present, and have been received in good condition. Notify the dealer immediately and retain packing material for inspection if any parts appear damaged from shipping or the carton itself shows signs of mishandling. Save the carton and all packing materials. In the event that a fixture must be returned to the factory, it is important that the fixture be returned in the original factory box and packing.

Your shipment includes:

- Showtec Net-8/3
- Schuko to Pro power connector power cable (1,3 m)
- User manual

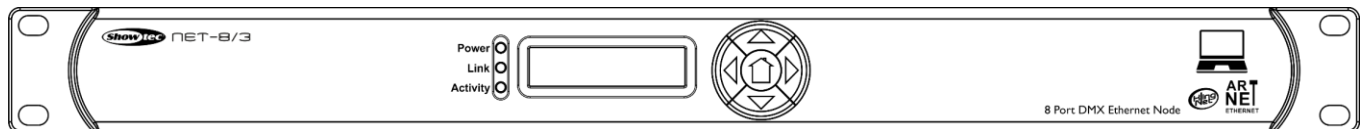
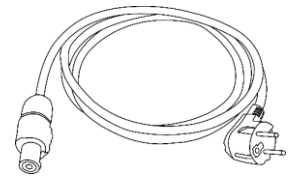

CAUTION!
Keep this device away from rain and moisture!
Unplug mains lead before opening the housing!

**Safety Instructions**

Every person involved with the installation, operation and maintenance of this device has to:

- be qualified
- follow the instructions of this manual



CAUTION! Be careful with your operations.
**With a dangerous voltage you can suffer
a dangerous electric shock when touching the wires!**



Before your initial start-up, please make sure that there is no damage caused by transportation. Should there be any, consult your dealer and do not use the device.

To maintain perfect condition and to ensure a safe operation, it is absolutely necessary for the user to follow the safety instructions and warning notes written in this manual.

Please consider that damages caused by manual modifications to the device are not subject to warranty.

This device contains no user-serviceable parts. Refer servicing to qualified technicians only.

IMPORTANT:

The manufacturer will not accept liability for any resulting damages caused by the non-observance of this manual or any unauthorized modification to the device.

- Never let the power cord come into contact with other cables! Handle the power cord and all connections with the mains with particular caution!
- Never remove warning or informative labels from the unit.
- Never use anything to cover the ground contact.
- Never leave any cables lying around.
- Do not connect this device to a dimmer pack.
- Do not switch the device on and off in short intervals, as this would reduce the device's life.
- Do not touch the device's housing bare-handed during its operation. Allow the fixture to cool for at least 5 minutes before handling.
- Do not shake the device. Avoid brute force when installing or operating the device.
- Only use device indoors, avoid contact with water or other liquids.
- Only operate the fixture after having checked that the housing is firmly closed and all screws are tightly fastened.
- Only operate the device after having familiarized with its functions.
- Avoid flames and do not put close to flammable liquids or gases.
- Always keep case closed while operating.
- Always allow free air space of at least 50 cm around the unit for ventilation.
- Always disconnect power from the mains, when device is not used or before cleaning! Only handle the power cord by the plug. Never pull out the plug by tugging the power cord.
- Make sure that the device is not exposed to extreme heat, moisture or dust.
- Make sure that the available voltage is not higher than stated on the rear panel.
- Make sure that the power cord is never crimped or damaged. Check the device and the power cord from time to time.
- If device is dropped or struck, disconnect mains power supply immediately. Have a qualified engineer inspect for safety before operating.
- If the device has been exposed to drastic temperature fluctuation (e.g. after transportation), do not switch it on immediately. The arising condensation water might damage your device. Leave the device switched off until it has reached room temperature.
- If your Showtec device fails to work properly, discontinue use immediately. Pack the unit securely (preferably in the original packing material), and return it to your Showtec dealer for service.
- For adult use only. Device must be installed out of the reach of children. Never leave the unit running unattended.
- Never attempt to bypass the thermostatic switch or fuses.
- The user is responsible for correct positioning and operating of the Net-8/3. The manufacturer will not accept liability for damages caused by the misuse or incorrect installation of this device.
- This device falls under protection class I. Therefore it is essential to connect the yellow/green conductor to earth.
- Repairs, servicing and electric connection must be carried out by a qualified technician.
- **WARRANTY:** Till one year after date of purchase.

Operating Determinations

- This device is not designed for permanent operation. Consistent operation breaks will ensure that the device will serve you for a long time without defects.
- The maximum ambient temperature $t_a = 40\text{ °C}$ must never be exceeded.
- In order to eliminate wear and improve the device's lifespan, during periods of non-use, completely disconnect from power source via breaker or by unplugging.
- The relative humidity must not exceed 50 % with an ambient temperature of 40 °C .
- If this device is operated in any other way, than the one described in this manual, the product may suffer damages and the warranty becomes void.
- Any other operation may lead to dangers like short-circuit, burns, electric shock, crash etc.

You endanger your own safety and the safety of others!

Improper installation can cause serious damage to people and property!

Connection with the mains

Connect the device to the mains with the power-plug.

Always pay attention, that the right color cable is connected to the right place.

International	EU Cable	UK Cable	US Cable	Pin
L	BROWN	RED	YELLOW/COPPER	PHASE
N	BLUE	BLACK	SILVER	NULL
	YELLOW/GREEN	GREEN	GREEN	EARTH

Make sure that the device is always properly connected to the earth!

Improper installation can cause serious injuries and/or damage of property!



Return Procedure

Returned merchandise must be sent prepaid and in the original packing, call tags will not be issued. Package must be clearly labeled with a Return Authorization Number (RMA number). Products returned without an RMA number will be refused. Highlite will not accept the returned goods or any responsibility. Call Highlite 0031-455667723 or mail offersales@highlite.com and request an RMA prior to shipping the fixture. Be prepared to provide the model number, serial number and a brief description of the cause for the return. Be sure to properly pack fixture, any shipping damage resulting from inadequate packaging is the customer's responsibility. Highlite reserves the right to use its own discretion to repair or replace product(s). As a suggestion, proper UPS packing or double-boxing is always a safe method to use.

Note: If you are given an RMA number, please include the following information on a piece of paper inside the box:

- 01) Your name
- 02) Your address
- 03) Your phone number
- 04) A brief description of the symptoms

Claims

The client has the obligation to check the delivered goods immediately upon delivery for any shortcomings and/or visible defects, or perform this check after our announcement that the goods are at their disposal. Damage incurred in shipping is the responsibility of the shipper; therefore the damage must be reported to the carrier upon receipt of merchandise.

It is the customer's responsibility to notify and submit claims with the shipper in the event that a fixture is damaged due to shipping. Transportation damage has to be reported to us within one day after receipt of the delivery.

Any return shipment has to be made post-paid at all times. Return shipments must be accompanied with a letter defining the reason for return shipment. Non-prepaid return shipments will be refused, unless otherwise agreed in writing.

Complaints against us must be made known in writing or by fax within 10 working days after receipt of the invoice. After this period complaints will not be handled anymore.

Complaints will only then be considered if the client has so far complied with all parts of the agreement, regardless of the agreement of which the obligation is resulting.

Description of the device

Features

The Showtec Net-8/3 node is a cutting-edge network routing device which converts ArtNET to DMX-512 and DMX-512 to ArtNet. A maximum of 4096 channels can be transmitted over a single CAT5. This makes the Net-8/3 suitable for small and large-scale events. The Net-8/3 embeds a built-in network switch to be used as an ethernet repeater as well as 8 isolated DMX-512 universes which can be used as an input or output.

- Supports ArtNet and KlingNet protocols
- 1 Gbps data speed
- 8 universes: DMX IN or OUT
- High speed network IN and OUT
- Input voltage: 100–240 V AC, 50/60 Hz
- Power consumption: 20 W
- Connections: 8 x 3-pin XLR IN/OUT, 2 x RJ45 IN/OUT, Pro power connector Blue IN
- Control protocol: ArtNet, KlingNet, sACN, TCP/IPv4, DMX-512
- LCD display for easy setup
- IP rating: IP20
- Operating temperature: From -5 °C to +40 °C
- Fuse: T1AL/250 V
- Dimensions: 483 x 143 x 44,5 mm (LxWxH); 19 inch x 1U (LxH)
- Weight: 2,2 kg

Frontside

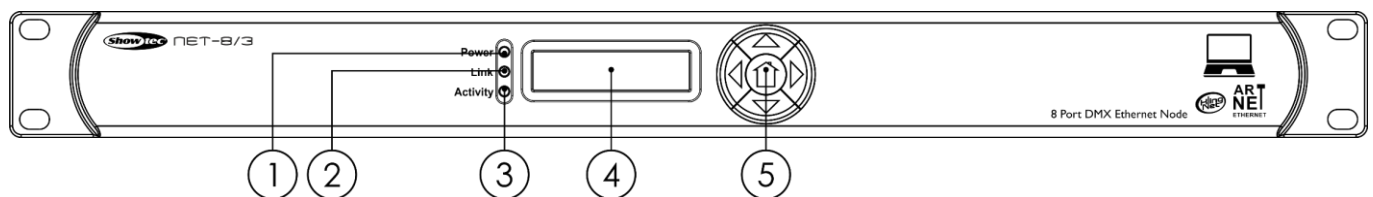

Fig. 01

- 01) Power LED indicator
This indicator will light up when you switch power on.
- 02) Link LED indicator
This indicator will light up when a network signal is received.
- 03) Activity LED indicator
This indicator will light up when a DMX signal is received.
- 04) LCD display
- 05) Control buttons

Backside

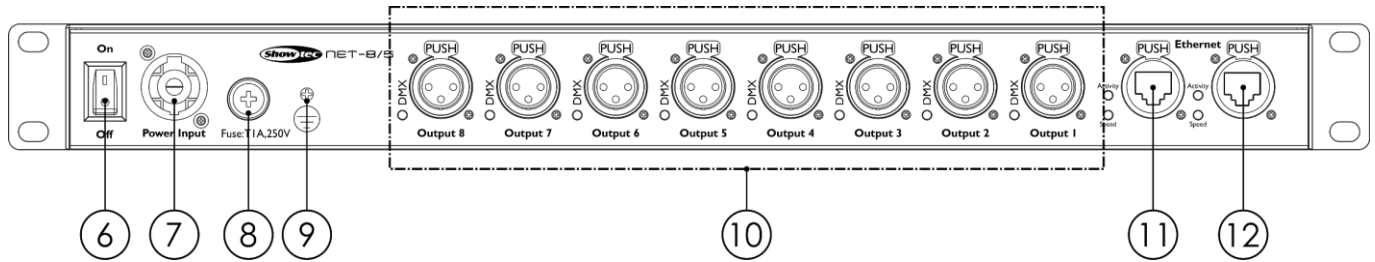

Fig. 02

- 06) Power switch ON/OFF
- 07) Pro power connector Blue IN
- 08) Fuse T1A/250 V
- 09) Ground/earth connection
- 10) 8 x 3-pin XLR DMX OUT with LED indicators
- 11) Ethernet RJ45 connector 1 with Activity and Speed LED indicators
- 12) Ethernet RJ45 connector 2 with Activity and Speed LED indicators

Installation

Remove all packing materials from the Net-8/3. Check that all foam and plastic padding is removed. Connect all cables.

Do not supply power before the whole system is set up and connected properly.

Always disconnect from electric mains power supply before cleaning or servicing.

Damages caused by non-observance are not subject to warranty.

Set Up and Operation

Follow the directions below, as they pertain to your preferred operation mode.

Before plugging the unit in, always make sure that the power supply matches the product specification voltage. Do not attempt to operate a 120V specification product on 230V power, or vice versa.

Control Modes

Setup Net-8/3 with Laptop/PC

- 01) Fasten the Net-8/3 to a 19-inch rack.
- 02) Use a 3-pin XLR cable to connect the Net-8/3 DMX outputs to your fixtures.
- 03) Connect the network switch to the Net-8/3 (CAT5, CAT6 cable).
- 04) Connect the laptop/PC to the network switch (CAT5, CAT6 cable).
- 05) Supply electric power: Plug the unit's mains power cord into a proper electric power supply socket.
Do not supply power before the whole system is set up and connected properly.
- 06) Set the IP address of your laptop/PC to 2.0.0.1 and the Net's to 2.0.0.2.

Setup Net-8/3 with Laptop/PC

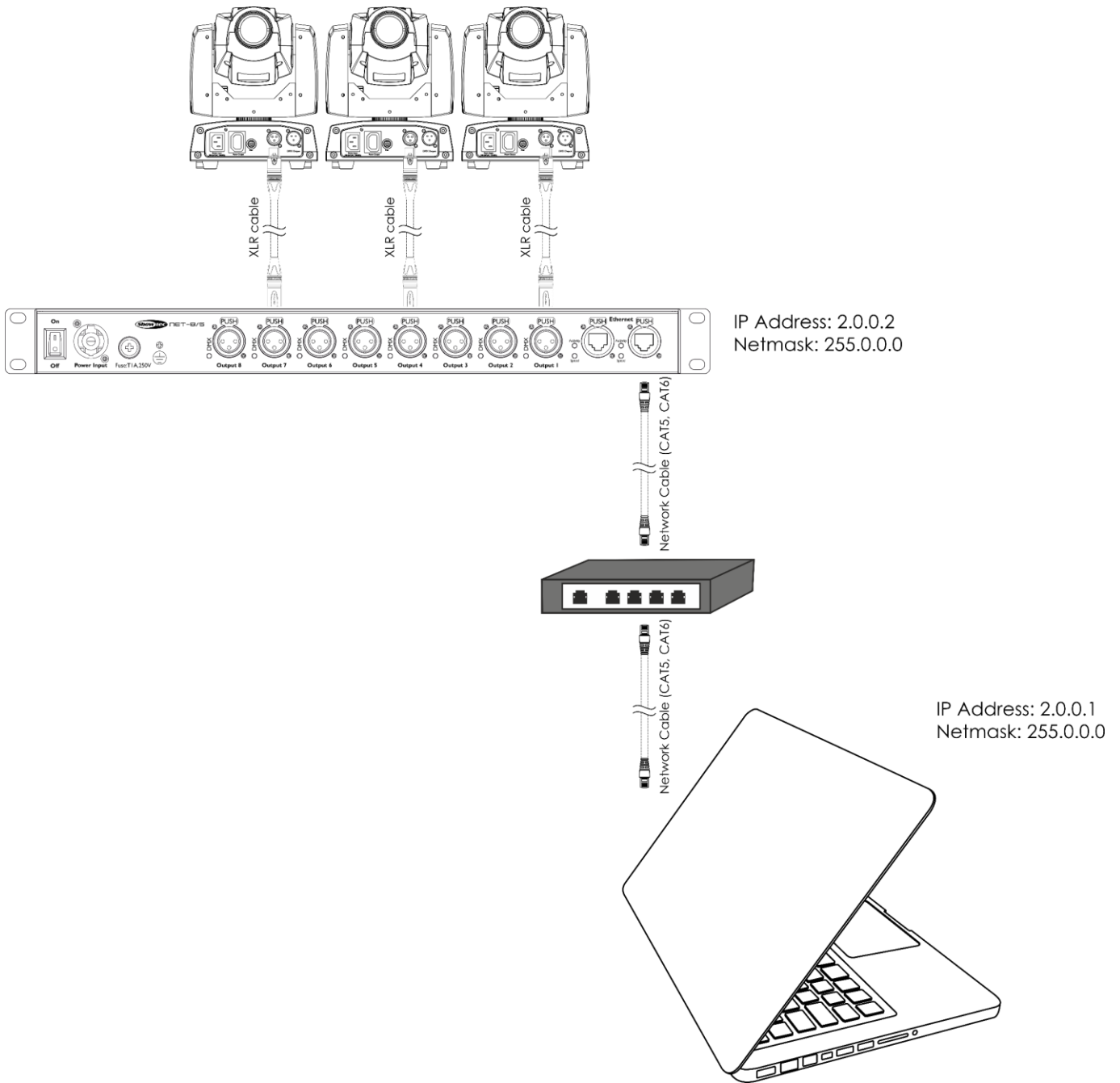

Fig. 03

Note: Link all cables before connecting electric power

Setup Net-8/3 with Lighting controller

- 01) Fasten the Net-8/3 to a 19-inch rack.
- 02) Use a 3-pin XLR cable to connect the Net-8/3 DMX outputs to your fixtures.
- 03) Connect the network switch to the Net-8/3 (CAT5, CAT6 cable).
- 04) Connect the lighting controller to the network switch (CAT5, CAT6 cable).
- 05) Supply electric power: Plug the unit's mains power cord into a proper electric power supply socket.
Do not supply power before the whole system is set up and connected properly.
- 06) Set the IP address of your lighting controller to 2.0.0.1 and the Net's to 2.0.0.2.

Setup Net-8/3 with Lighting controller

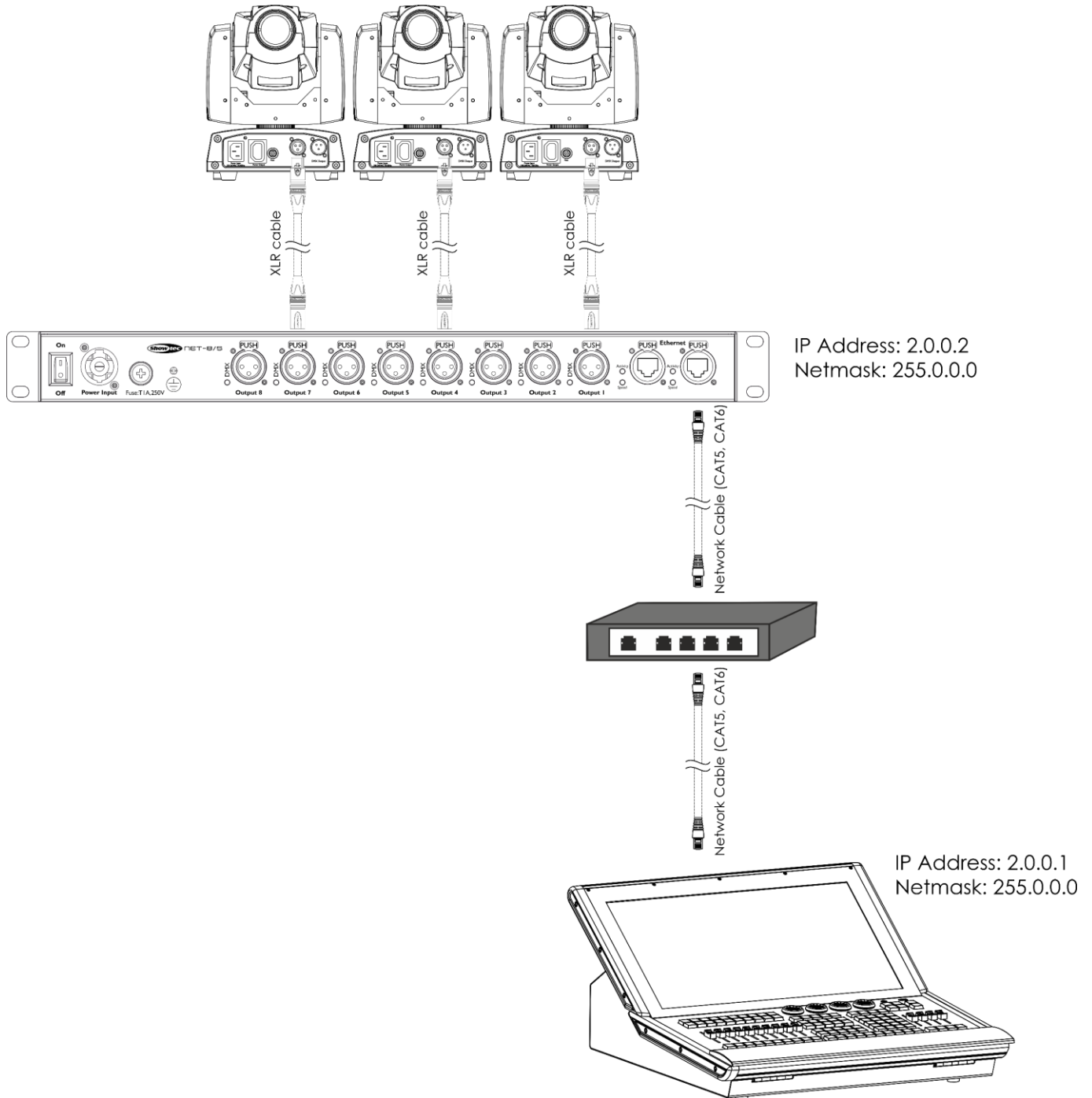

Fig. 04

Note: Link all cables before connecting electric power

Fixture Linking

You will need a serial data link to run light shows of one or more fixtures using a DMX-512 controller or to run synchronized shows of two or more fixtures set to a master/slave operating mode. The combined number of channels required by all the fixtures on a serial data link determines the number of fixtures the data link can support.

Important: Fixtures on a serial data link must be daisy-chained in a single line. To comply with the EIA-485 standard, no more than 30 devices should be connected on one data link. Connecting more than 30 fixtures on one serial data link without the use of a DMX optically isolated splitter may result in deterioration of the digital DMX signal.



Maximum recommended DMX data link distance: 100 meters
Maximum recommended number of fixtures on a DMX data link: 30 fixtures

Data Cabling

To link fixtures together you must obtain data cables. You can purchase DAP Audio certified DMX cables directly from a dealer/distributor or construct your own cable. If you choose to create your own cable please use data-grade cables that can carry a high quality signal and are less prone to electromagnetic interference.

DAP Audio DMX Data Cables

- DAP Audio Basic microphone cable for allround use. bal. XLR/M 3-pin > XLR/F 3-pin. **Ordercode** FL01150 (1,5 m), FL013 (3 m), FL016 (6 m), FL0110 (10 m), FL0115 (15 m), FL0120 (20 m).
- DAP Audio X-type data cable XLR/M 3-pin > XLR/F 3-pin. **Ordercode** FLX0175 (0,75 m), FLX01150 (1,5 m), FLX013 (3 m), FLX016 (6 m), FLX0110 (10 m).
- DAP Audio cable for the demanding user with exceptional audio-qualities and connector made by Neutrik®. **Ordercode** FL71150 (1,5 m), FL713 (3 m), FL716 (6 m), FL7110 (10 m).
- DAP Audio cable for the demanding user with exceptional audio-qualities and connector made by Neutrik®. **Ordercode** FL7275 (0,75 m), FL72150 (1,5 m), FL723 (3 m), FL726 (6 m), FL7210 (10 m).
- DAP Audio 110 Ohm cable with digital signal transmission. **Ordercode** FL0975 (0,75 m), FL09150 (1,5 m), FL093 (3 m), FL096 (6 m), FL0910 (10 m), FL0915 (15 m), FL0920 (20 m).
- DAP Audio data cable FL08 DMX/AES-EBU, XLR/M 5-pin > XLR/F 5-pin. **Ordercode** FL08150 (1,5 m), FL083 (3 m), FL086 (6 m), FL0810 (10 m), FL0820 (20 m).
- DAP Audio DMX adapter: 5-pin/3-pin. **Ordercode** FLA29.
- DAP Audio DMX adapter: 3-pin/5-pin. **Ordercode** FLA30.
- DAP Audio DMX Terminator 3-pin. **Ordercode** FLA42.
- DAP Audio DMX Terminator 5-pin. **Ordercode** FLA43.

DAP Audio PC Interface Cables

- CAT-5 cable 7,6 mm Matte blue PVC. **Ordercode** FL55150 (1,5 m), FL553 (3 m), FL556 (6 m), FL5510 (10 m), FL5515 (15 m), FL5520 (20 m).
- CAT-6 cable (recommended for best data transfer). **Ordercode** FL563 (3 m), FL566 (6 m), FL5610 (10 m), FL5615 (15 m), FL5640 (40 m).

Control Panel

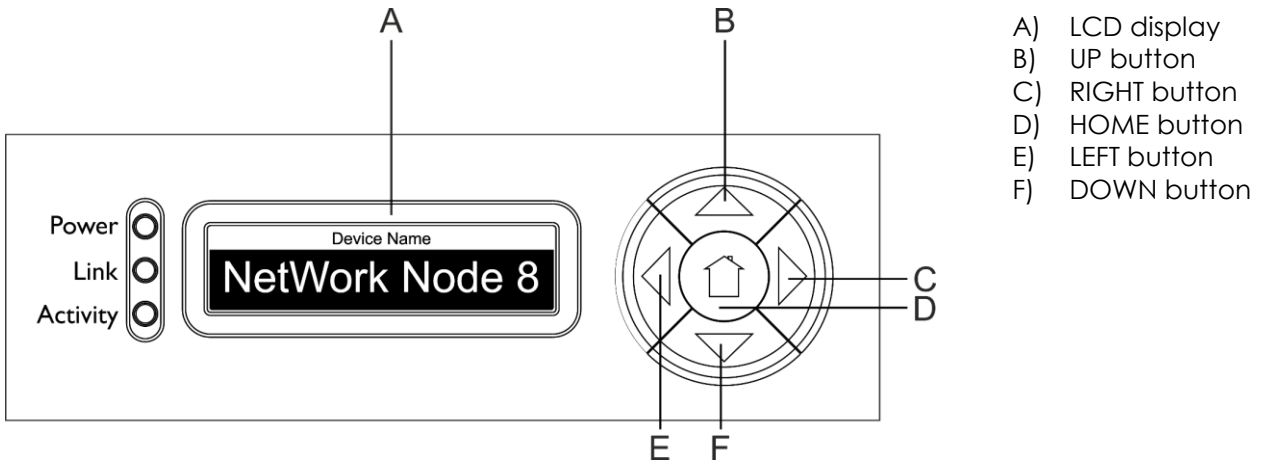
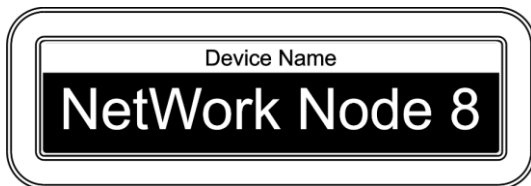

Fig. 05

Status Menu

At the start-up you can navigate through the 5 status modes. They provide you with instant information about the most important parameters.

- Press the **UP/DOWN** buttons to navigate.



This menu shows the device's name which can be changed in the main menu. For more information see "1.Rename" on page 12.

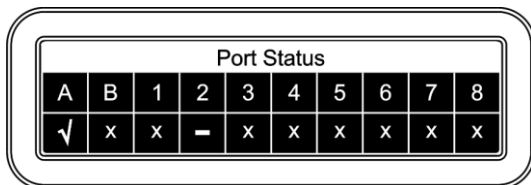

This menu shows which port is connected (√), not connected (X) or disabled (-).

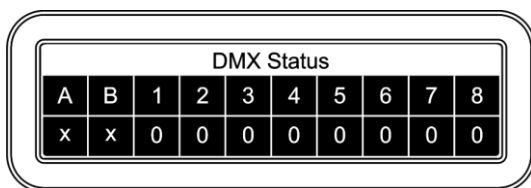

This menu shows which port is an input (I), output (O) or disabled (X).

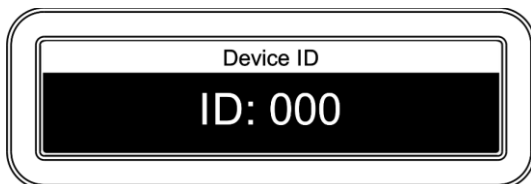

This menu shows the device's ID. For more information see "6.Set Device ID" on page 15.

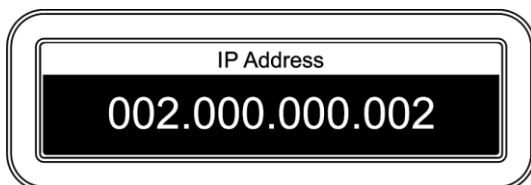

This menu shows the device's IP address. For more information see "3.Set IP Address" on page 13).

- Press the **LEFT** button to enter the main menu.

Main Menu Options

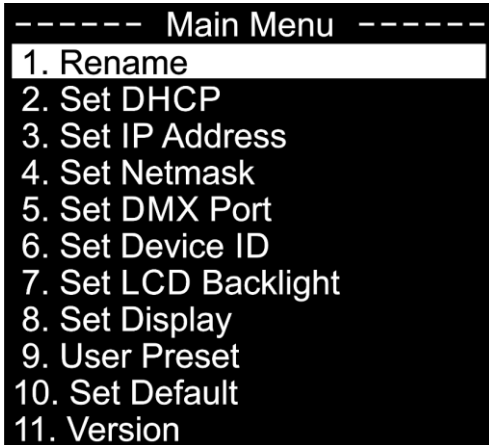

1. Rename
2. Set DHCP
3. Set IP Address
4. Set Netmask
5. Set DMX Port
6. Set Device ID
7. Set LCD Backlight
8. Set Display
9. User Preset
10. Set Default
11. Version

Note: If no button is pressed within 30 seconds, the display will return to the start-up screen (Status menu).

1. Rename

- 01) Press the **LEFT** button to enter the main menu.
- 02) Press the **UP/DOWN** buttons to select RENAME and press the **RIGHT** button to open the submenu.
The display shows:

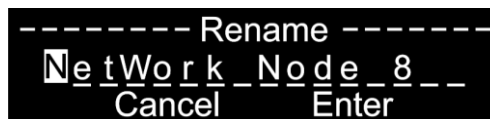

- 03) Press the **UP/DOWN** buttons to scroll through the letters, CANCEL and ENTER.
- 04) Press the **RIGHT** button to select a letter. The selected letter will be highlighted.
- 05) Press the **UP/DOWN** buttons to change the selected letter.
- 06) Press the **RIGHT** button to confirm.
- 07) Repeat steps 3–6 to edit the remaining letters.
- 08) Press the **UP/DOWN** buttons to select CANCEL (to exit without saving) or ENTER (to save the new name).
- 09) Press the **RIGHT** button to confirm.

2. Set DHCP

- 01) Press the **LEFT** button to enter the main menu.
- 02) Press the **UP/DOWN** buttons to select SET DHCP and press the **RIGHT** button to open the submenu.
The display shows:



- 03) Press the **UP/DOWN** buttons to choose ENABLE or DISABLE.
- 04) Press the **RIGHT** button to confirm.
- 05) If you select ENABLE, the network switch will automatically provide an IP address to the device.
- 06) If you select DISABLE, you will have to set the IP address manually.

3. Set IP Address

- 01) Press the **LEFT** button to enter the main menu.
- 02) Press the **UP/DOWN** buttons to select SET IP ADDRESS and press the **RIGHT** button to open the submenu. The display shows:

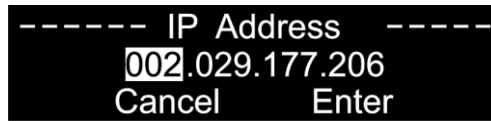

- 03) Press the **UP/DOWN** buttons to scroll through the address sections, CANCEL and ENTER.
- 04) Press the **RIGHT** button to select the desired address section.
- 05) Press the **UP/DOWN** buttons to change the numbers (0–255). (Alternatively, press and hold down the **UP/DOWN** buttons for quick search.)
- 06) Press the **RIGHT** button to confirm.
- 07) Repeat steps 3–6 to edit the remaining address sections.
- 08) Press the **UP/DOWN** buttons to select CANCEL (to discard changes) or ENTER (to confirm the new IP address).
- 09) Press the **RIGHT** button to confirm.

Note: It is possible to change the IP address **ONLY** if DHCP (see page 12) is **disabled**.

4. Set Netmask

- 01) Press the **LEFT** button to enter the main menu.
- 02) Press the **UP/DOWN** buttons to select SET NETMASK and press the **RIGHT** button to open the submenu. The display shows:

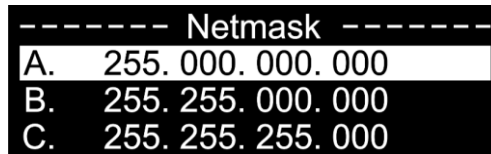

- 03) Press the **UP/DOWN** buttons to scroll through the 3 options: A, B or C.
- 04) The selected option will be highlighted.
- 05) Press the **RIGHT** button to confirm.

5. Set DMX Port

- 01) Press the **LEFT** button to enter the main menu.
- 02) Press the **UP/DOWN** buttons to select SET DMX PORT and press the **RIGHT** button to open the submenu. The display shows:

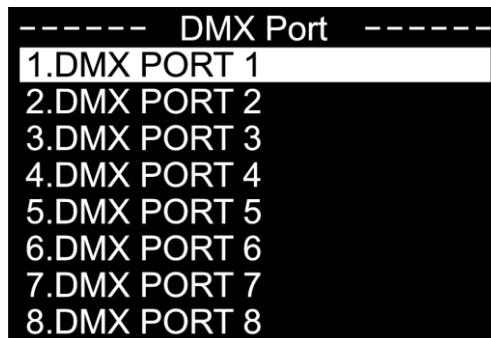

- 03) Press the **UP/DOWN** buttons to scroll through the ports 1–8.

04) Press the **RIGHT** button to select a port. The display shows:

----- DMX Port 2 -----	
1. Disp Type	DEC
2. DMX Status	OUTPUT
3. DMX Mode	LTP
4. Protocol	ArtNet
5. Framerte/fs	040
6. Network	000
7. Primary	001
8. Secondary	009
9. Resend	017

05) Press the **UP/DOWN** buttons to scroll through the following options:

- DISP TYPE (Display type)
 - DEC: Decimal display (0–255)
 - HEX: Hexadecimal display (00H–FFH)
- DMX STATUS (DMX port status)
 - INPUT: The port will be used as an input.
 - OUTPUT: The port will be used as an output.
 - DISABLE: The port will be disabled.
- DMX MODE (Depends on whether the port is set as an input or output.)
 - If the port is set as input:
 - NORMAL: The DMX port receives the DMX signal and sends it to the first selected ArtNet universe.
 - BACKUP: In case of a failure, or when there are no DMX values on the first selected ArtNet universe for more than 3 seconds, the Net-8/3 starts sending the DMX values from the backup port.
 - If the port is set as output:
 - SINGLE: The DMX signal is sent to the DMX port from the first selected ArtNet universe.
 - HTP: The DMX signal is sent to the DMX port from the merging of the 1st and 2nd ArtNet selected universes. It will compare the values on the inputs and will send the **highest** value to the DMX port for each DMX channel in both universes.
 - LTP: The DMX signal is sent to the DMX port from the merging of the 1st and 2nd ArtNet selected universe. It will compare the values on the inputs and will send the **last changed** value to the DMX port for each DMX channel in both universes.
- PROTOCOL: Choose ArtNet, KlingNet or sACN.
- FRAMERTE/FS: Set the DMX frames per second which will be sent. Choose from: 10, 15, 20, 25, 30, 35 or 40 frames per second.
- PIXEL TYPE: Set the desired pixel type (RGB, RGBAW, RGBD, RGBA, RGBW). **This option is visible only when protocol is set to KlingNet.**
- PIXEL WIDTH: Set the pixel width, when using KlingNet (0–170). **This option is visible only when protocol is set to KlingNet.**
- PIXEL HEIGHT: Set the pixel height, when using KlingNet (0–170). **This option is visible only when protocol is set to KlingNet.**
- NETWORK: Set your network (0–127).
- PRIMARY: Set the 1st ArtNet universe dedicated to this port (0–255).
- SECONDARY: Set the 2nd ArtNet universe dedicated to this port (0–255). **This option is visible only when the port is set as output, the DMX mode is set to HTP or LTP and the protocol is sACN or ArtNet.**
- RESEND: The merged signal from the 1st and 2nd ArtNet universe keeps sending data, if there is no activity. Choose which Artnet universe (0–255 and DISABLED) the data needs to be sent to. **This option is visible only when the port is set as output, the DMX mode is set to HTP or LTP and the protocol is sACN or ArtNet.**

06) Press the **RIGHT** button to select the desired option.

07) Press the **UP/DOWN** buttons to change the values.

08) Press the **RIGHT** button to confirm.

09) Press the **LEFT** button to go to the previous submenu.

10) Press the **LEFT** button again to return to the main menu.

6. Set Device ID

- 01) Press the **LEFT** button to enter the main menu.
- 02) Press the **UP/DOWN** buttons to select SET DEVICE ID and press the **RIGHT** button to open the submenu. The display shows:



- 03) Press the **UP/DOWN** buttons to highlight the number in the middle of the screen.
- 04) Press the **RIGHT** button to select the number.
- 05) Press the **UP/DOWN** buttons to change the value. The adjustment range is among 0–255.
- 06) Press the **RIGHT** button to confirm.
- 07) Press the **UP/DOWN** buttons to select CANCEL (to exit without saving) or ENTER (to save the new ID).
- 08) Press the **RIGHT** button to confirm.

7. Set LCD Backlight

- 01) Press the **LEFT** button to enter the main menu.
- 02) Press the **UP/DOWN** buttons to select SET LCD BACKLIGHT and press the **RIGHT** button to open the submenu. The display shows:



- 03) Press the **UP/DOWN** buttons to choose one of the 3 options: ON (the display remains on), 10 seconds or 30 seconds.
- 04) Press the **RIGHT** button to confirm.
- 05) If no button is pressed within the preset amount of time, the display will turn off.

8. Set Display

- 01) Press the **LEFT** button to enter the main menu.
- 02) Press the **UP/DOWN** buttons to select SET DISPLAY and press the **RIGHT** button to open the submenu. The display shows:



- 03) Press the **UP/DOWN** buttons to choose NORMAL or INVERSION.
- 04) Press the **RIGHT** button to confirm.
- 05) If you select INVERSION, the display will be horizontally flipped.

9. User Preset

- 01) Press the **LEFT** button to enter the main menu.
- 02) Press the **UP/DOWN** buttons to select USER PRESET and press the **RIGHT** button to open the submenu. The display shows:

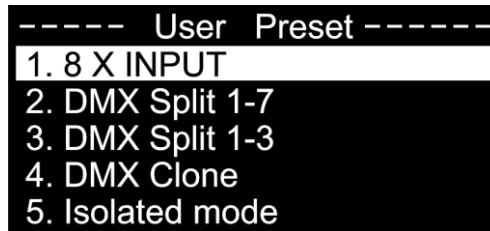

- 03) Press the **UP/DOWN** buttons to scroll through the 5 options:
 - 8 X INPUT: The node converts 8 x DMX inputs into 8 separate ArtNet universes.
 - DMX SPLIT 1–7: DMX splitter with 1 input and 7 isolated DMX outputs (DMX port 1 is an input and DMX port 2–8 are outputs.)
 - DMX SPLIT 1–3: DMX splitter with 2 x DMX inputs and 3 isolated DMX outputs (DMX port 1 is an input and DMX ports 2–4 are outputs. DMX port 5 is an input and DMX ports 6–8 are outputs.)
 - DMX CLONE: The node converts 4 x DMX inputs into 4 separate ArtNet universes and duplicates the 4 input signals to the DMX ports 5–8. A network configuration needs to be carried out according to your network and your ArtNet receiver specifications.
 - ISOLATED MODE: The node receives 8 separate ArtNet universes and sends them to the 8 DMX output ports. A network configuration needs to be carried out according to your network and your ArtNet receiver specifications.
- 04) Press the **RIGHT** button to confirm.

10. Set Default

- 01) Press the **LEFT** button to enter the main menu.
- 02) Press the **UP/DOWN** buttons to select SET DEFAULT and press the **RIGHT** button to open the submenu. The display shows:

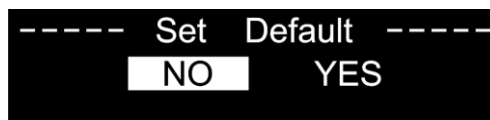

- 03) Press the **UP/DOWN** buttons to select NO or YES.
- 04) Press the **RIGHT** button to confirm.
- 05) If you choose YES, the device will be reset and the factory default settings will be restored.

11. Version

- 01) Press the **LEFT** button to enter the main menu.
- 02) Press the **UP/DOWN** buttons to select VERSION and press the **RIGHT** button to open the submenu. The display shows:



Maintenance

The operator has to make sure that safety-related and machine-technical installations are to be inspected by an expert after every year in the course of an acceptance test.

The operator has to make sure that safety-related and machine-technical installations are to be inspected by a skilled person once a year.

The following points have to be considered during the inspection:

- 01) All screws used for installing the device or parts of the device have to be tightly connected and must not be corroded.
- 02) There may not be any deformations on housings, fixations and installation spots.
- 03) Mechanically moving parts like axles, eyes and others may not show any traces of wearing.
- 04) The electric power supply cables must not show any damages or material fatigue.

The Showtec Net-8/3 requires almost no maintenance. However, you should keep the unit clean. Disconnect the mains power supply and then wipe the cover with a damp cloth. Wipe the front glass panel clean with glass cleaner and a soft cloth. Do not use alcohol or solvents. Do not immerse in liquid. Keep connections clean. Disconnect electric power, and then wipe the DMX and audio connections with a damp cloth. Make sure connections are thoroughly dry before linking equipment or supplying electric power.

Replacing the Fuse

Power surges, short-circuit or inappropriate electrical power supply may cause a fuse to burn out. If the fuse burns out, the product will not function whatsoever. If this happens, follow the directions below.

- 01) Unplug the unit from electric power source.
- 02) Insert a flat-headed screwdriver into a slot in the fuse cover. Turn the screwdriver to the left, at the same time gently push a bit (Turn and Push). The fuse will come out.
- 03) Remove the used fuse. If brown or unclear, it is burned out.
- 04) Insert the replacement fuse into the holder where the old fuse was. Reinsert the fuse holder. Be sure to use a fuse of the same type and specification. See the product specification label for details.

Troubleshooting

No Light

This troubleshooting guide is meant to help solve simple problems.

If a problem occurs, carry out the steps below in sequence until a solution is found. Once the unit operates properly, do not carry out following steps.

If the light effect does not operate properly, refer servicing to a technician.

Suspect three potential problem areas as: the power supply, the distributor or the fuse.

- 01) Power supply. Check if the unit is plugged into an appropriate power supply.
- 02) The distributor. Return the Net-8/3 to your Showtec dealer.
- 03) The fuse. Replace the fuse. See page 17 for replacing the fuse.
- 04) If all appears to be O.K., plug the unit in again.
- 05) If you are unable to determine the cause of the problem, do not open the Net-8/3, as this may damage the unit and the warranty will become void.
- 06) Return the device to your Showtec dealer.

No Response to DMX

Suspect the DMX cable or connectors, a controller malfunction, a light effect DMX card malfunction.

- 01) Check the DMX setting. Make sure that DMX addresses are correct.
- 02) Check the DMX cable: Unplug the unit; change the DMX cable; then reconnect to electrical power. Try your DMX control again.
- 03) Determine whether the DMX recorder, light controller or light effect is at fault. Does the controller operate properly with other DMX products? If not, take the controller in for repair. If so, take the DMX cable and/or the light effect to a qualified technician.

Problem	Probable cause(s)	Solution
One or more fixtures do not function at all	No power to the fixture	<ul style="list-style-type: none"> • Check if power is switched on and cables are plugged in
	Primary fuse blown	<ul style="list-style-type: none"> • Replace fuse
Fixtures reset correctly, but all respond erratically or not at all to the controller	ArtNet protocol is not active	<ul style="list-style-type: none"> • Configure and activate ArtNet
	The controller is not connected.	<ul style="list-style-type: none"> • Connect controller
Fixtures reset correctly, but some respond erratically or not at all to the controller	3-pin XLR Out of the controller does not match XLR Out of the first fixture on the link (i.e. signal is reversed)	<ul style="list-style-type: none"> • Install a phase reversing cable between the controller and the first fixture on the link
	Poor data quality	<ul style="list-style-type: none"> • Check data quality. If much lower than 100 percent, the problem may be a bad data link connection, poor quality or broken cables, missing termination plug, or a defective fixture disturbing the link
	Bad data link connection	<ul style="list-style-type: none"> • Inspect connections and cables. Correct poor connections. Repair or replace damaged cables.
	Data link not terminated with 120 Ohm termination plug	<ul style="list-style-type: none"> • Insert termination plug in output jack of the last fixture on the link
	Incorrect addressing of the fixtures	<ul style="list-style-type: none"> • Check address setting
	One of the fixtures is defective and disturbs data transmission on the link	<ul style="list-style-type: none"> • Bypass one fixture at a time until normal operation is restored: unplug both connectors and connect them directly together • Have the defective fixture serviced by a qualified technician
	3-pin XLR Out on the fixtures does not match (pins 2 and 3 reversed)	<ul style="list-style-type: none"> • Install a phase-reversing cable between the fixtures or swap pin 2 and 3 in the fixture that behaves erratically
	LEDs/lamp damaged	<ul style="list-style-type: none"> • Check the user manual of the defective fixture
The power supply settings do not match local AC voltage and frequency	<ul style="list-style-type: none"> • Disconnect fixture. Check settings and correct if necessary 	

Product Specifications

Model:	Showtec Net-8/3
Input voltage:	100–240 V AC, 50/60 Hz
Power consumption:	20 W
Fuse:	T1AL/250 V
Dimensions:	483 x 143 x 44,5 mm (LxWxH) 19 inch x 1U (LxH)
Weight:	2,2 kg
Operation and Programming	
Signal pin OUT:	pin 1 earth, pin 2 (-), pin 3 (+), pin 4 (N/C), pin 5 (N/C)
Setup:	LCD display for easy setup
Connections:	8 x 3-pin XLR IN/OUT, 2 x RJ45 IN/OUT
Power connection:	Pro power connector Blue IN
Control protocol:	ArtNET, KlingNET, sACN, TCP/IPv4, DMX-512
Electro-mechanical effects	
8 universes DMX IN/OUT	
Supports Artnet or Klingnet protocol	
Data signal: 1 Gbps data speed	
IP20 rating	
Max. ambient temperature t_a :	From -5 °C to +40 °C
Max. housing temperature t_B	70 °C
Minimum distance:	
Minimum distance from flammable surfaces:	0,5 m

Design and product specifications are subject to change without prior notice.



Website: www.Showtec.info
Email: service@highlite.com

Dimensions

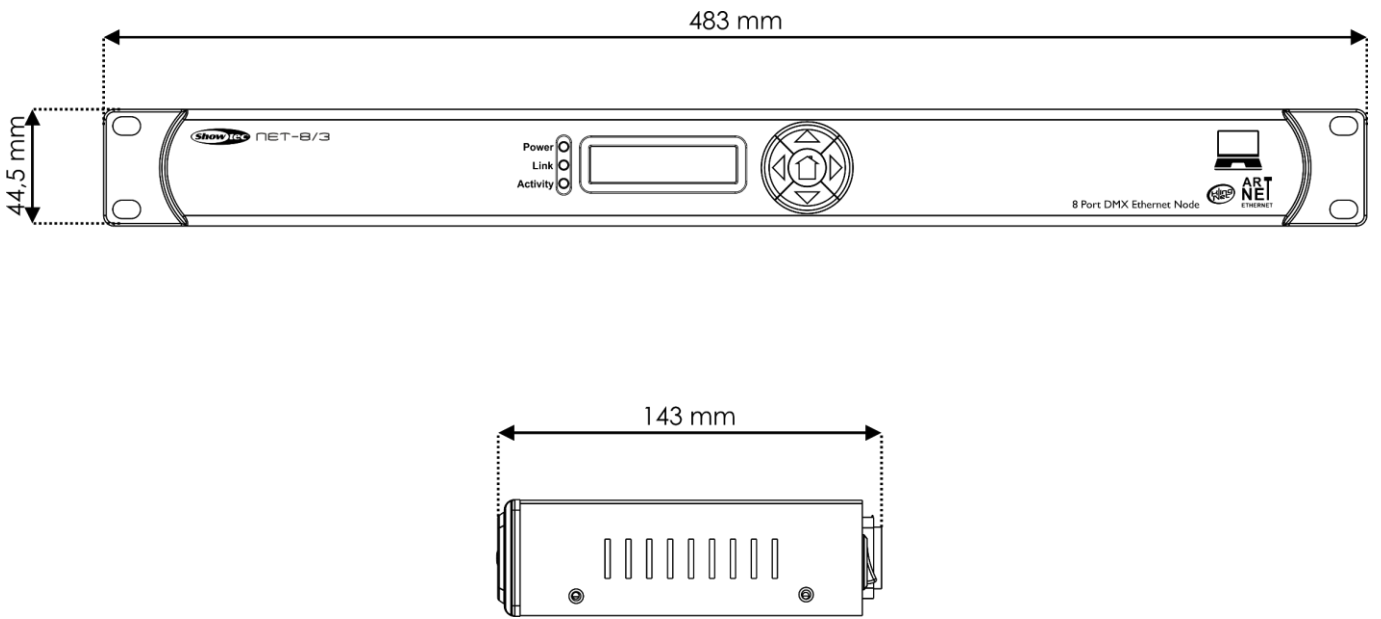



©2020 Showtec