

Table of contents

Warning	2
Safety Instructions	2
Operating Determinations	3
Return Procedure	4
Claims	4
Description of the device	5
Overview	5
Backside	5
Installation	6
Flush-mounted Wall Box U40 Installation	6
Setup and Operation	7
RJ45 Connector	7
Maintenance	8
Troubleshooting	8
No Light	8
No Response to DMX	8
Product Specifications	10

Warning



**For your own safety, please read this user manual carefully
before your initial start-up!**



Unpacking Instructions

Immediately upon receiving this product, carefully unpack the carton and check the contents to ensure that all parts are present, and have been received in good condition. Notify the dealer immediately and retain packing material for inspection if any parts appear damaged from shipping or the carton itself shows signs of mishandling. Save the carton and all packing materials. In the event that a fixture must be returned to the factory, it is important that the fixture be returned in the original factory box and packing.

Your shipment includes:

- Showtec TR-512 Wallpanel (RJ45)
- User manual

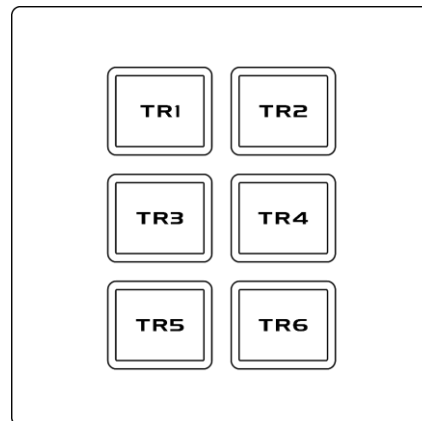

CAUTION!
Keep this device away from rain and moisture!
Unplug mains lead before opening the housing!



Safety Instructions

Every person involved with the installation, operation and maintenance of this device has to:

- be qualified
- follow the instructions of this manual



CAUTION! Be careful with your operations.
**With a dangerous voltage you can suffer
a dangerous electric shock when touching the wires!**



Before your initial start-up, please make sure that there is no damage caused by transportation. Should there be any, consult your dealer and do not use the device.

To maintain perfect condition and to ensure a safe operation, it is absolutely necessary for the user to follow the safety instructions and warning notes written in this manual.

Please consider that damages caused by manual modifications to the device are not subject to warranty.

This device contains no user-serviceable parts. Refer servicing to qualified technicians only.

IMPORTANT:

The manufacturer will not accept liability for any resulting damages caused by the non-observance of this manual or any unauthorized modification to the device.

- Never remove warning or informative labels from the unit.
- Never use anything to cover the ground contact.
- Never leave any cables lying around.
- Do not connect this device to a dimmer pack.
- Do not switch the device on and off in short intervals, as this would reduce the device's life.
- Do not shake the device. Avoid brute force when installing or operating the device.
- Only use device indoors, avoid contact with water or other liquids.
- Only operate the device after having checked if the housing is firmly closed and all screws are tightly fastened.
- Only operate the device after having familiarized with its functions.
- Avoid flames and do not put close to flammable liquids or gases.
- Always keep case closed while operating.
- Always disconnect power from the mains, when device is not used or before cleaning!
- Make sure that the device is not exposed to extreme heat, moisture or dust.
- If device is dropped or struck, disconnect mains power supply immediately. Have a qualified engineer inspect for safety before operating.
- If the device has been exposed to drastic temperature fluctuation (e.g. after transportation), do not switch it on immediately. The arising condensation water might damage your device. Leave the device switched off until it has reached room temperature.
- If your Showtec device fails to work properly, discontinue use immediately. Pack the unit securely (preferably in the original packing material), and return it to your Showtec dealer for service.
- For adult use only. Device must be installed out of the reach of children. Never leave the unit running unattended.
- Never attempt to bypass the thermostatic switch or fuses.
- The user is responsible for correct positioning and operating of the TR-512 Wallpanel (RJ45). The manufacturer will not accept liability for damages caused by the misuse or incorrect installation of this device.
- Repairs, servicing and electric connection must be carried out by a qualified technician.
- WARRANTY: Till one year after date of purchase.

Operating Determinations

- This device is not designed for permanent operation. Consistent operation breaks will ensure that the device will serve you for a long time without defects.
- The maximum ambient temperature $t_a = 40\text{ °C}$ must never be exceeded.
- The relative humidity must not exceed 50 % with an ambient temperature of 40 °C .
- If this device is operated in any other way, than the one described in this manual, the product may suffer damages and the warranty becomes void.
- Any other operation may lead to dangers like short-circuit, burns, electric shock, crash etc.

You endanger your own safety and the safety of others!

Improper installation can cause serious damage to people and property !



Return Procedure

Returned merchandise must be sent prepaid and in the original packing, call tags will not be issued. Package must be clearly labeled with a Return Authorization Number (RMA number). Products returned without an RMA number will be refused. Highlite will not accept the returned goods or any responsibility. Call Highlite 0031-455667723 or mail aftersales@highlite.com and request an RMA prior to shipping the fixture. Be prepared to provide the model number, serial number and a brief description of the cause for the return. Be sure to properly pack fixture, any shipping damage resulting from inadequate packaging is the customer's responsibility. Highlite reserves the right to use its own discretion to repair or replace product(s). As a suggestion, proper UPS packing or double-boxing is always a safe method to use.

Note: If you are given an RMA number, please include the following information on a piece of paper inside the box:

- 01) Your name
- 02) Your address
- 03) Your phone number
- 04) A brief description of the symptoms

Claims

The client has the obligation to check the delivered goods immediately upon delivery for any shortcomings and/or visible defects, or perform this check after our announcement that the goods are at their disposal. Damage incurred in shipping is the responsibility of the shipper; therefore the damage must be reported to the carrier upon receipt of merchandise.

It is the customer's responsibility to notify and submit claims with the shipper in the event that a fixture is damaged due to shipping. Transportation damage has to be reported to us within one day after receipt of the delivery.

Any return shipment has to be made post-paid at all times. Return shipments must be accompanied with a letter defining the reason for return shipment. Non-prepaid return shipments will be refused, unless otherwise agreed in writing.

Complaints against us must be made known in writing or by fax within 10 working days after receipt of the invoice. After this period complaints will not be handled anymore.

Complaints will only then be considered if the client has so far complied with all parts of the agreement, regardless of the agreement of which the obligation is resulting.

Description of the device

Features

The TR-512 Wallpanel (RJ45) is a compact wall panel equipped with 6 trigger buttons. Each trigger can start either a show or a scene. Each show can be played in a loop mode or single play mode. It is also possible to set a delay, which enhances your control of the shows.

- Trigger buttons: 6
- Connections: Trigger connector RJ45
- Installation depth: 29 mm
- Housing: Brushed Aluminum
- IP rating: IP20
- Dimensions: 85 x 85 x 36 mm (LxWxH)
- Weight: 0,1 kg

Optional accessories

[50825](#) – TR-512

Overview

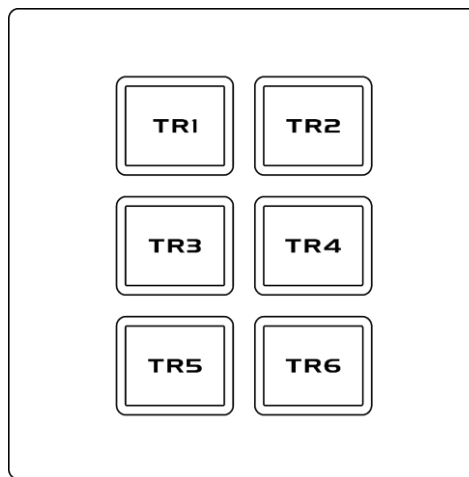

Fig. 01

Backside

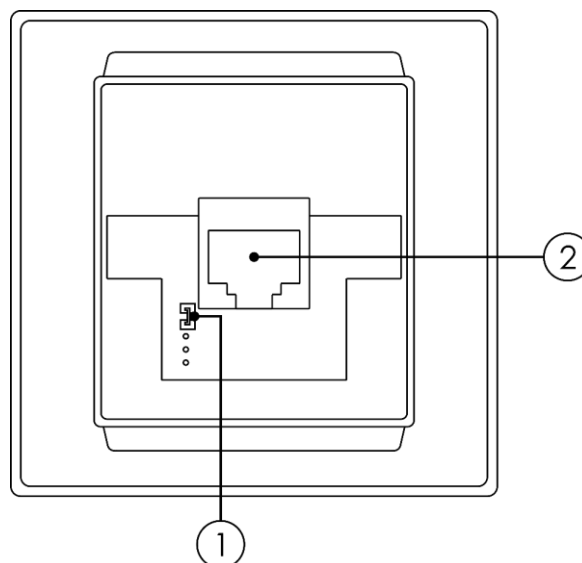

Fig. 02

01) Jumper

02) RJ45 connector OUT

Use this connector to connect the Wallpanel to the TR-512 (50825).

Installation

Remove all packing materials from the TR-512 Wallpanel (RJ45). Check that all foam and plastic padding is removed. Connect all cables.

Do not supply power before the whole system is set up and connected properly.

Always disconnect from electric mains power supply before cleaning or servicing.

Damages caused by non-observance are not subject to warranty.

Flush-mounted Wall Box U40 Installation

Install the TR-512 Wallpanel on a flush-mounted wall box (U40).

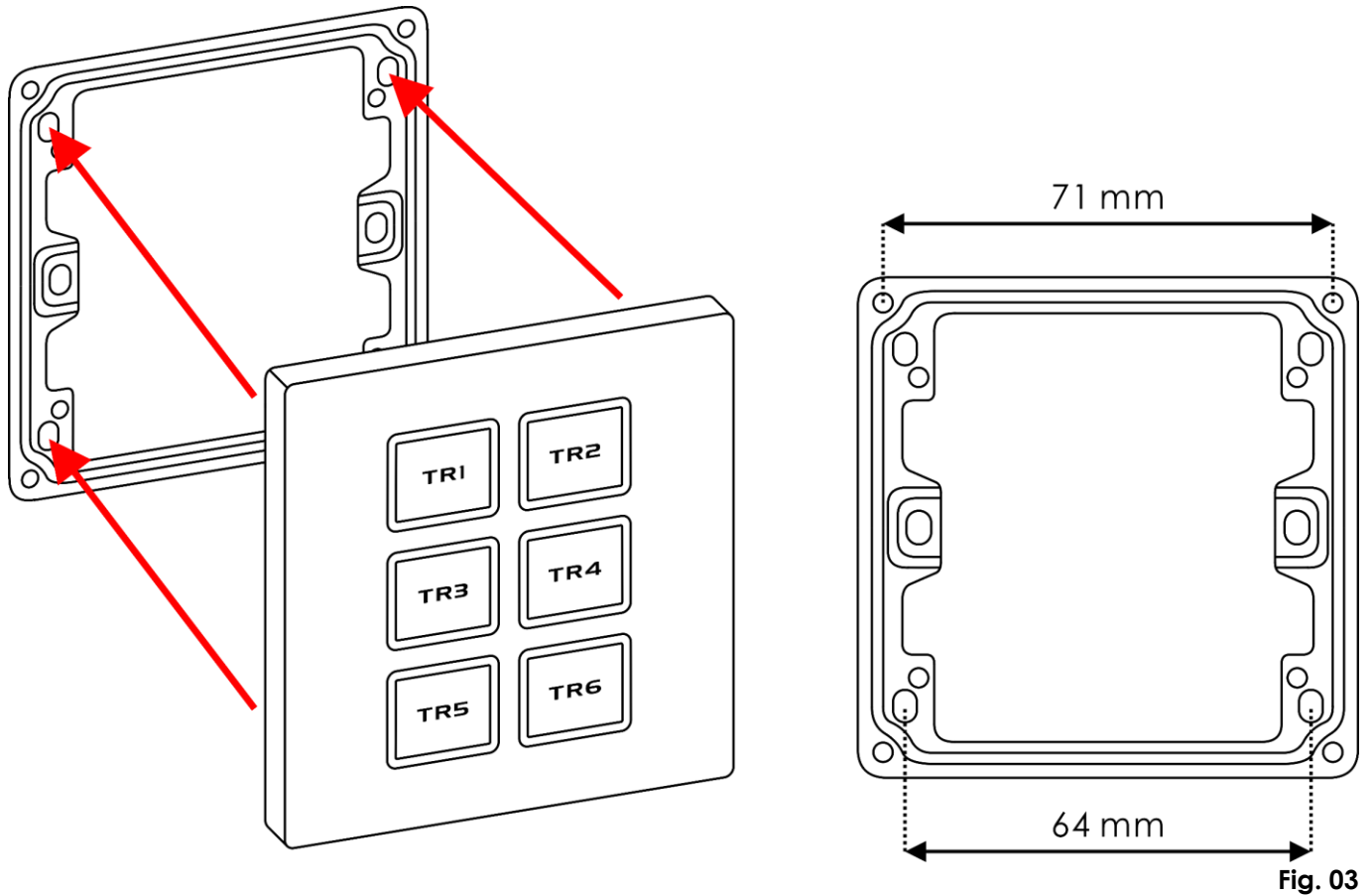

Setup and Operation

Follow the directions below, as they pertain to your preferred operation mode.

Before plugging the unit in, always make sure that the power supply matches the product specification voltage. Do not attempt to operate a 115 V specification product on 230 V power, or vice versa.

- 01) Connect the Wallpanel to the TR-512 trigger (50825) by means of a CAT cable. **Recommended maximum CAT cable length: 25 m.**
- 02) You can install the Wallpanel in two ways, **with or without the jumper**. Please, see Fig. 02 page 5.
 - **With** the jumper: The TR-512 trigger (50825) should be set to **TOGGLE_TR**. Press one of the 6 trigger buttons on the Wallpanel to run a program. Press the button again to immediately stop the program. Refer to the user manual of the TR-512 (50825) for more information.
 - **Without** the jumper: The TR-512 trigger (50825) should be set to **NO_TR**. Press one of the 6 trigger buttons on the Wallpanel to run a program. If you press the button again, the device will wait until the currently active program reaches its end and then it will stop. Refer to the user manual of the TR-512 (50825) for more information.
- 03) Press the trigger buttons to activate/deactivate desired programs. The corresponding trigger button will light up when active.

RJ45 Connector

Please follow the instructions below in order to create an RJ45 trigger connector.

Pinout

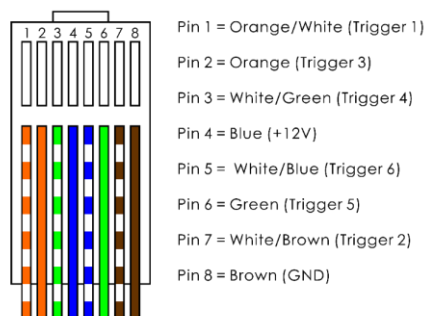

Trigger Connection

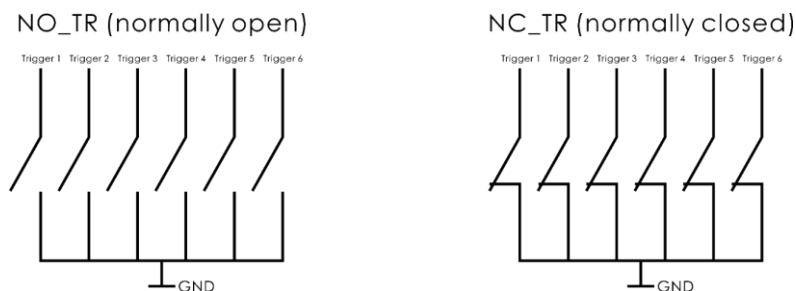

Fig. 04

It is possible to use each of the 4 modes (NO_TR, NC_TR, TOGGLE_TR, AUTO_TR) independently, for separate triggers (1-6). Make sure that your settings are correct. Refer to the user manual of the TR-512 (50825) for more information.

Maintenance

The operator has to make sure that safety-related and machine-technical installations are to be inspected by an expert after every year in the course of an acceptance test.

The operator has to make sure that safety-related and machine-technical installations are to be inspected by a skilled person once a year.

The following points have to be considered during the inspection:

- 01) All screws used for installing the device or parts of the device have to be tightly connected and must not be corroded.
- 02) There may not be any deformations on housings, fixations and installation spots.
- 03) Mechanically moving parts like axles, eyes and others may not show any traces of wearing.
- 04) The electric power supply cables must not show any damages or material fatigue.

The TR-512 Wallpanel (RJ45) requires almost no maintenance. However, you should keep the unit clean. Disconnect the mains power supply, and then wipe the cover with a damp cloth. Do not immerse in liquid. Do not use alcohol or solvents.

Keep connections clean. Disconnect electric power, and then wipe the connections with a damp cloth. Make sure connections are thoroughly dry before linking equipment or supplying electric power.

Troubleshooting

No Light

This troubleshooting guide is meant to help solve simple problems.

If a problem occurs, carry out the steps below in sequence until a solution is found. Once the unit operates properly, do not carry out following steps.

If the DMX trigger, the Wallpanel or the light effect does not operate properly, refer servicing to a technician.

Suspect four potential problem areas as: the power supply, the DMX trigger, the Wallpanel and the light fixture.

- 01) Power supply. Check if the unit is plugged into an appropriate power supply.
- 02) The DMX trigger. Return the TR-512 (50825) to your Showtec dealer.
- 03) The Wallpanel. Return the Wallpanel (50824) to your Showtec dealer.
- 04) The light fixture. Return your light fixture to your dealer.
- 05) If all appears to be O.K., plug the unit in again.
- 06) If you are unable to determine the cause of the problem, do not open the TR-512 or the Wallpanel, as this may damage the unit(s) and the warranty will become void.
- 07) Return the device(s) to your Showtec dealer.

No Response to DMX

Suspect the DMX cable or connectors, a controller malfunction, a light effect DMX card malfunction.

- 01) Check the DMX setting. Make sure that DMX addresses are correct.
- 02) Check the DMX cable: Unplug the unit; change the DMX cable; then reconnect to electrical power. Try your DMX control again.
- 03) Determine whether the DMX trigger, light controller or light effect is at fault. Does the controller operate properly with other DMX products? If not, take the controller in for repair. If so, take the DMX cable and/or the light effect to a qualified technician.

Problem	Probable cause(s)	Remedy
The device does not function at all	No power to the device	<ul style="list-style-type: none"> • Check if power is switched on and cables are plugged in
Fixtures reset correctly, but all respond erratically or not at all to the controller	The controller is not connected 3-pin XLR Out of the DMX trigger does not match XLR In of the fixture on the link (i.e. signal is reversed)	<ul style="list-style-type: none"> • Connect controller • Install a phase reversing cable between the controller and the first fixture on the link
Fixtures reset correctly, but some respond erratically or not at all to the DMX trigger	Poor data quality	<ul style="list-style-type: none"> • Check data quality. If much lower than 100 percent, the problem may be a bad data link connection, poor quality or broken cables, missing termination plug, or a defective fixture disturbing the link
	Bad data link connection	<ul style="list-style-type: none"> • Inspect connections and cables. Correct poor connections. Repair or replace damaged cables
	Data link not terminated with 120 Ohm termination plug	<ul style="list-style-type: none"> • Insert termination plug in output jack of the last fixture on the link
	Incorrect addressing of the fixtures 3-pin XLR Out on the fixtures does not match (pins 2 and 3 reversed)	<ul style="list-style-type: none"> • Check address setting • Install a phase-reversing cable between the fixtures or swap pins 2 and 3 in the fixture
No light or LEDs/lamp cut out intermittently	Fixture is too hot	<ul style="list-style-type: none"> • Allow fixture to cool down • Turn up the air conditioning
	LEDs/lamp damaged	<ul style="list-style-type: none"> • Disconnect fixture and return to your dealer
	The power supply settings do not match local AC voltage and frequency	<ul style="list-style-type: none"> • Disconnect fixture. Check settings and correct if necessary

Product Specifications

Model:	Showtec TR-512 Wallpanel (RJ45)
Dimensions:	85 x 85 x 36 mm (LxWxH)
Weight:	0,1 kg
Operation and Programming	
Signal output:	RJ45 OUT
Electro-mechanical effects	
Trigger buttons:	6
Installation depth:	29 mm
Connections:	Trigger connector RJ45
Housing:	Brushed Aluminum
IP rating:	IP20
Max. ambient temperature ta:	40 °C
Max. housing temperature tB	80 °C

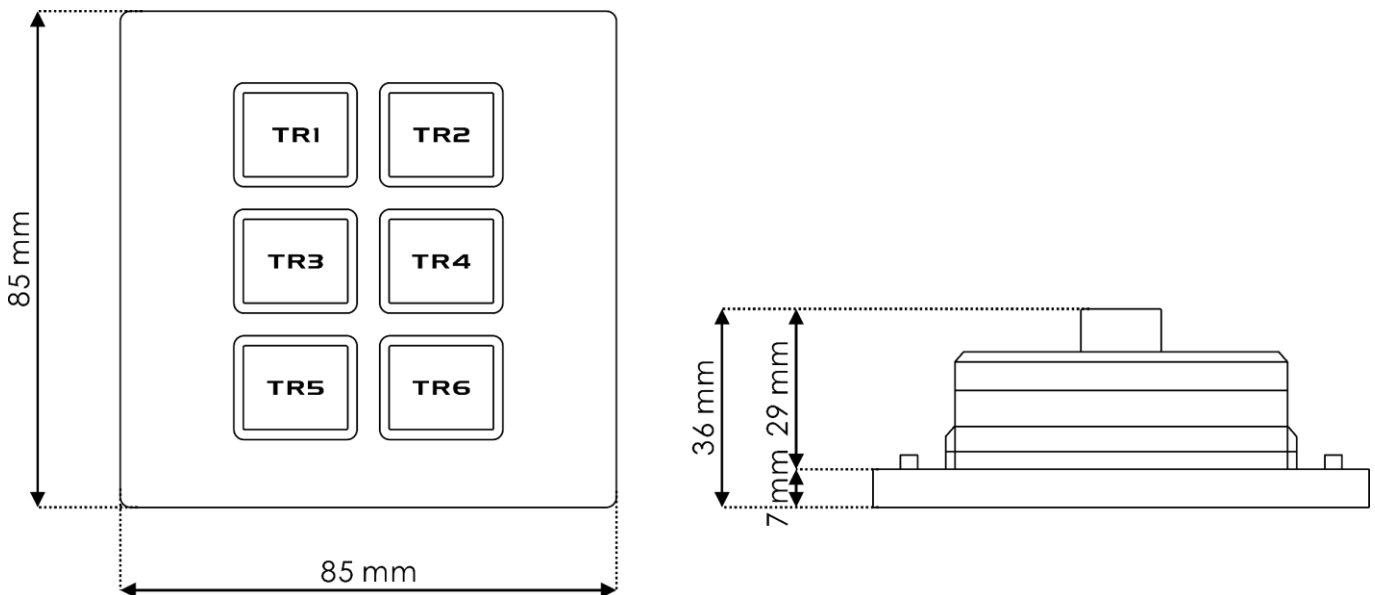

Design and product specifications are subject to change without prior notice.



Website: www.Showtec.info
Email: service@highlite.com



©2019 Showtec