

ENGLISH

TR-512

V3

Ordercode: 50825

## Table of contents

---

<b>Warning</b> .....	2
Safety Instructions .....	2
Operating Determinations .....	3
Connection with the mains .....	4
Return Procedure .....	4
Claims .....	4
<b>Description of the device</b> .....	5
Overview .....	5
<b>Installation</b> .....	6
<b>Set Up and Operation</b> .....	6
Control Modes .....	6
Data Cabling .....	7
Control Panel .....	7
Control Mode .....	7
Main Menu Options .....	8
1. Play Show .....	8
2. Record Show .....	9
3. Delete Show .....	10
4. Trigger Event .....	11
4.1. Status .....	11
4.2. Rename .....	11
4.3. Show .....	12
4.4. Mode .....	12
4.5. Delay .....	12
5. Stop TR Event .....	12
6. Device Settings .....	13
6.1. Device Label .....	13
6.2. DMX Port Option .....	13
6.3. Display Option .....	14
6.4. Version .....	14
7. Save Configuration .....	15
8. Load Configuration .....	16
9. Default Setting .....	16
RJ45 Connector .....	17
Installation of the TR-512 Wallpanel RJ45 (ordercode: 50824) .....	18
Overview .....	18
Backside .....	18
<b>Maintenance</b> .....	19
<b>Troubleshooting</b> .....	19
No Light .....	19
No Response to DMX .....	19
<b>Product Specifications</b> .....	21
<b>Dimensions</b> .....	22
50825 – TR-512 .....	22
50824 – TR-512 Wallpanel (RJ45) .....	22

## Warning



**For your own safety, please read this user manual carefully  
before your initial start-up!**



### Unpacking Instructions

Immediately upon receiving this product, carefully unpack the carton and check the contents to ensure that all parts are present, and have been received in good condition. Notify the dealer immediately and retain packing material for inspection if any parts appear damaged from shipping or the carton itself shows signs of mishandling. Save the carton and all packing materials. In the event that a fixture must be returned to the factory, it is important that the fixture be returned in the original factory box and packing.

### Your shipment includes:

- Showtec TR-512
- MicroSD card
- 12V DC power adapter, 1500 mA (1,2 m)
- User manual

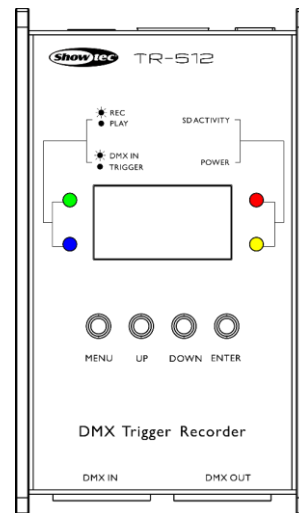

**CAUTION!**  
**Keep this device away from rain and moisture!**  
**Unplug mains lead before opening the housing!**



### Safety Instructions

Every person involved with the installation, operation and maintenance of this device has to:

- be qualified
- follow the instructions of this manual



**CAUTION! Be careful with your operations.**  
**With a dangerous voltage you can suffer  
a dangerous electric shock when touching the wires!**



Before your initial start-up, please make sure that there is no damage caused by transportation. Should there be any, consult your dealer and do not use the device.

To maintain perfect condition and to ensure a safe operation, it is absolutely necessary for the user to follow the safety instructions and warning notes written in this manual.

Please consider that damages caused by manual modifications to the device are not subject to warranty.

This device contains no user-serviceable parts. Refer servicing to qualified technicians only.

**IMPORTANT:**

The manufacturer will not accept liability for any resulting damages caused by the non-observance of this manual or any unauthorized modification to the device.

- Never let the power cord come into contact with other cables! Handle the power cord and all connections with the mains with particular caution!
- Never remove warning or informative labels from the unit.
- Never use anything to cover the ground contact.
- Never leave any cables lying around.
- Do not connect this device to a dimmer pack.
- Do not switch the device on and off in short intervals, as this would reduce the device's life.
- Do not touch the device's housing bare-handed during its operation. Allow the device to cool for at least 5 minutes before handling.
- Do not shake the device. Avoid brute force when installing or operating the device.
- Only use device indoors, avoid contact with water or other liquids.
- Only operate the device after having checked that the housing is firmly closed and all screws are tightly fastened.
- Only operate the device after having familiarized with its functions.
- Avoid flames and do not put close to flammable liquids or gases.
- Always keep case closed while operating.
- Always disconnect power from the mains, when device is not used or before cleaning! Only handle the power cord by the plug. Never pull out the plug by tugging the power cord.
- Make sure that the device is not exposed to extreme heat, moisture or dust.
- Make sure that the available voltage is not higher than stated on the rear panel.
- Make sure that the power cord is never crimped or damaged. Check the device and the power cord from time to time.
- If device is dropped or struck, disconnect mains power supply immediately. Have a qualified engineer inspect for safety before operating.
- If the device has been exposed to drastic temperature fluctuation (e.g. after transportation), do not switch it on immediately. The arising condensation water might damage your device. Leave the device switched off until it has reached room temperature.
- If your Showtec device fails to work properly, discontinue use immediately. Pack the unit securely (preferably in the original packing material), and return it to your Showtec dealer for service.
- For adult use only. Device must be installed out of the reach of children. Never leave the unit running unattended.
- Never attempt to bypass the thermostatic switch or fuses.
- The user is responsible for correct positioning and operating of the TR-512. The manufacturer will not accept liability for damages caused by the misuse or incorrect installation of this device.
- This device falls under protection class I. Therefore it is essential to connect the yellow/green conductor to earth.
- Repairs, servicing and electric connection must be carried out by a qualified technician.
- WARRANTY: Till one year after date of purchase.

**Operating Determinations**

- This device is not designed for permanent operation. Consistent operation breaks will ensure that the device will serve you for a long time without defects.
- The maximum ambient temperature  $t_a = 40^\circ\text{C}$  must never be exceeded.
- The relative humidity must not exceed 50 % with an ambient temperature of  $40^\circ\text{C}$ .
- If this device is operated in any other way, than the one described in this manual, the product may suffer damages and the warranty becomes void.
- Any other operation may lead to dangers like short-circuit, burns, electric shock, crash etc.

*You endanger your own safety and the safety of others!*

*Improper installation can cause serious damage to people and property !*

## Connection with the mains

Connect the device to the mains with the power-plug.

Always pay attention, that the right color cable is connected to the right place.

International	EU Cable	UK Cable	US Cable	Pin
L	BROWN	RED	YELLOW/COPPER	PHASE
N	BLUE	BLACK	SILVER	NULL
	YELLOW/GREEN	GREEN	GREEN	EARTH

*Make sure that the device is always connected properly to the earth!*



## Return Procedure

Returned merchandise must be sent prepaid and in the original packing, call tags will not be issued. Package must be clearly labeled with a Return Authorization Number (RMA number). Products returned without an RMA number will be refused. Highlite will not accept the returned goods or any responsibility. Call Highlite 0031-455667723 or mail [aftersales@highlite.com](mailto:aftersales@highlite.com) and request an RMA prior to shipping the fixture. Be prepared to provide the model number, serial number and a brief description of the cause for the return. Be sure to properly pack fixture, any shipping damage resulting from inadequate packaging is the customer's responsibility. Highlite reserves the right to use its own discretion to repair or replace product(s). As a suggestion, proper UPS packing or double-boxing is always a safe method to use.

**Note: If you are given an RMA number, please include the following information on a piece of paper inside the box:**

- 01) Your name
- 02) Your address
- 03) Your phone number
- 04) A brief description of the symptoms

## Claims

The client has the obligation to check the delivered goods immediately upon delivery for any shortcomings and/or visible defects, or perform this check after our announcement that the goods are at their disposal. Damage incurred in shipping is the responsibility of the shipper; therefore the damage must be reported to the carrier upon receipt of merchandise.

It is the customer's responsibility to notify and submit claims with the shipper in the event that a fixture is damaged due to shipping. Transportation damage has to be reported to us within one day after receipt of the delivery.

Any return shipment has to be made post-paid at all times. Return shipments must be accompanied with a letter defining the reason for return shipment. Non-prepaid return shipments will be refused, unless otherwise agreed in writing.

Complaints against us must be made known in writing or by fax within 10 working days after receipt of the invoice. After this period complaints will not be handled anymore.

Complaints will only then be considered if the client has so far complied with all parts of the agreement, regardless of the agreement of which the obligation is resulting.

## Description of the device

### Features

The TR-512 is a compact but very powerful tool which can be used for triggering any light show or scene in a simple way. It can record and play several DMX shows at the same time. Those shows can be stored on a microSD card. Shows can be played by 6 external triggers or by the internal auto trigger. Each trigger can start either a show or a scene. Each show can be played in a loop mode or single play mode. It is also possible to set a delay, which enhances your control of the shows. The TR-512 is suitable for a large range of venues, such as: theme parks, museums, shops and many others.

- Input voltage: 100-240V AC, 50/60 Hz
- Power supply: 12V DC via the included power adapter, 1500mA
- Control protocol: DMX-512
- Connections: 3-pin XLR IN & OUT, microSD card IN, trigger connector RJ45 IN
- RJ45 connector for 6 external triggers
- Storage: MicroSD card (included)
- Housing: Aluminum extrusion
- IP rating: IP-20
- Dimensions (TR-512): 115 x 67 x 45 mm (LxWxH)
- Dimensions (Wallpanel): 85 x 85 x 36 mm (LxWxH)
- Weight (TR-512): 0,4 kg
- Weight (Wallpanel): 0,1 kg

### Optional accessories

50824 – TR-512 Wallpanel (RJ45) **(not included)**

### Overview

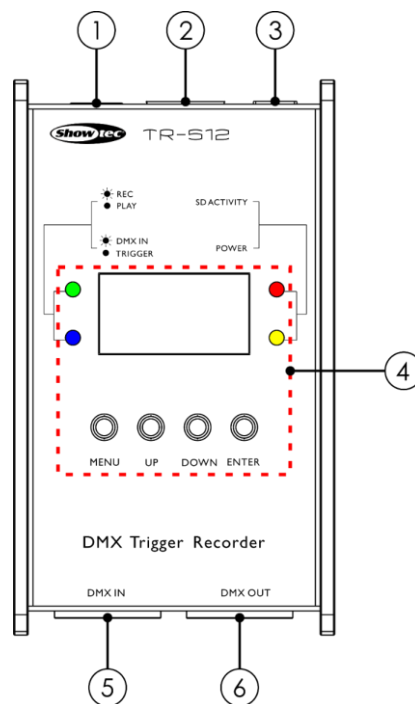

Fig. 01

- 01) **MicroSD card IN**  
Insert the included microSD card and store your shows and configuration files.
- 02) **Trigger connector RJ45 IN**  
Connect a maximum of 6 external triggers or the TR-512 Wallpanel (ordercode: 50824). Do not use for data transmission. See pages 17-18.
- 03) **12V DC power adapter IN**
- 04) **LCD display + control buttons + LED indicators**
- 05) **3-pin DMX signal connector IN**  
Connect a light controller (only when recording).
- 06) **3-pin DMX signal connector OUT**  
Connect a light fixture.

## Installation

Remove all packing materials from the TR-512. Check that all foam and plastic padding is removed. Connect all cables.

**Do not supply power before the whole system is set up and connected properly.**

**Always disconnect from electric mains power supply before cleaning or servicing.**

**Damages caused by non-observance are not subject to warranty.**

## Set Up and Operation

Follow the directions below, as they pertain to your preferred operation mode.

Before plugging the unit in, always make sure that the power supply matches the product specification voltage. Do not attempt to operate a 120V specification product on 230V power, or vice versa.

### Control Modes

There are 3 modes:

- DMX player
- DMX recorder
- DMX trigger

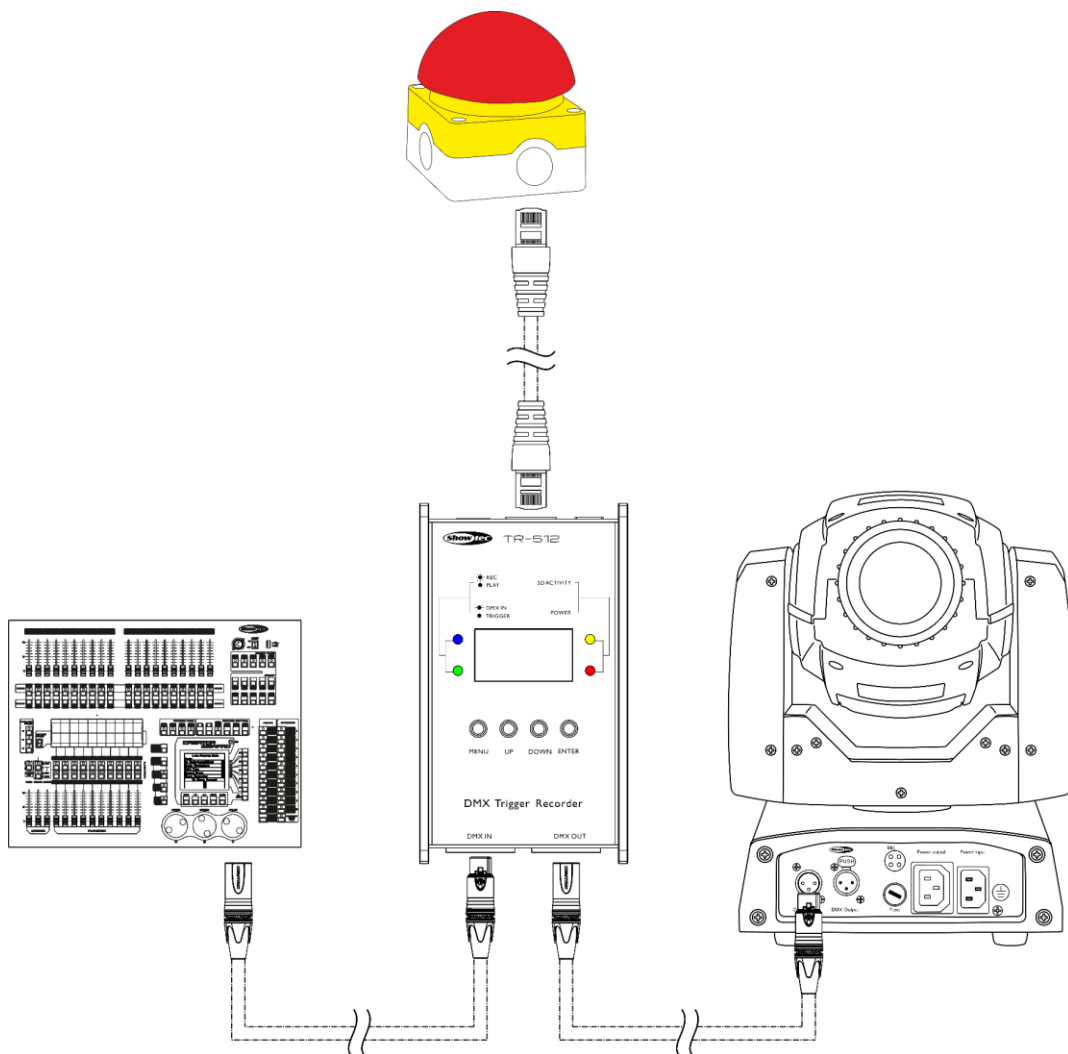

Fig. 02

**Note : Link all cables before connecting electric power**

## Data Cabling

To link fixtures together you must obtain data cables. You can purchase DAP Audio certified DMX cables directly from a dealer/distributor or construct your own cable. If you choose to create your own cable please use data-grade cables that can carry a high quality signal and are less prone to electromagnetic interference.

### DAP Audio DMX Data Cables

- DAP Audio Basic microphone cable for allround use. bal. XLR/M 3-pin > XLR/F 3-pin. **Ordercode** FL01150 (1,5 m), FL013 (3 m), FL016 (6 m), FL0110 (10 m), FL0115 (15 m), FL0120 (20 m).
- DAP Audio X-type data cable XLR/M 3-pin > XLR/F 3-pin. **Ordercode** FLX0175 (0,75 m), FLX01150 (1,5 m), FLX013 (3 m), FLX016 (6 m), FLX0110 (10 m).
- DAP Audio cable for the demanding user with exceptional audio-qualities and connector made by Neutrik®. **Ordercode** FL71150 (1,5 m), FL713 (3 m), FL716 (6 m), FL7110 (10 m).
- DAP Audio cable for the demanding user with exceptional audio-qualities and connector made by Neutrik®. **Ordercode** FL7275 (0,75 m), FL72150 (1,5 m), FL723 (3 m), FL726 (6 m), FL7210 (10 m).
- DAP Audio 110 Ohm cable with digital signal transmission. **Ordercode** FL0975 (0,75 m), FL09150 (1,5 m), FL093 (3 m), FL096 (6 m), FL0910 (10 m), FL0915 (15 m), FL0920 (20 m).
- DAP Audio data cable FL08 DMX/AES-EBU, XLR/M 5-pin > XLR/F 5-pin. **Ordercode** FL08150 (1,5 m), FL083 (3 m), FL086 (6 m), FL0810 (10 m), FL0820 (20 m).
- DAP Audio DMX adapter: 5-pin/3-pin. **Ordercode** FLA29.
- DAP Audio DMX adapter: 3-pin/5-pin. **Ordercode** FLA30.
- DAP Audio DMX Terminator 3-pin. **Ordercode** FLA42.
- DAP Audio DMX Terminator 5-pin. **Ordercode** FLA43.

## Control Panel

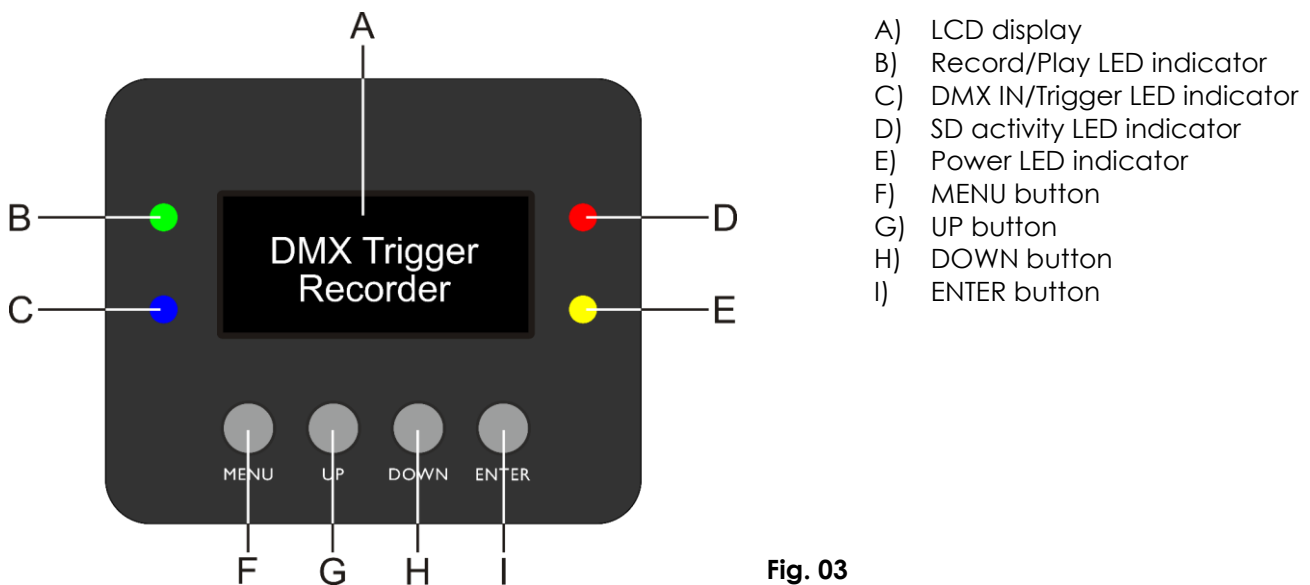

Fig. 03

## Control Mode

The TR-512 is connected to the controller and responds to the DMX signal from the controller.

### Controlling:

You can operate the TR-512 via your light controller.

**Note:** After switching on, the TR-512 will automatically detect whether DMX-512 data is received or not. If there is no data received at the DMX-input, the "LED" on the control panel will not flash.

If not, the problem may be:

- The XLR cable from the controller is not connected with the input of the TR-512.
- The controller is switched off or defective, the cable or connector is defective, or the signal wires are swapped in the input connector.



## Main Menu Options

01) Upon start-up, the device will show the start screen:

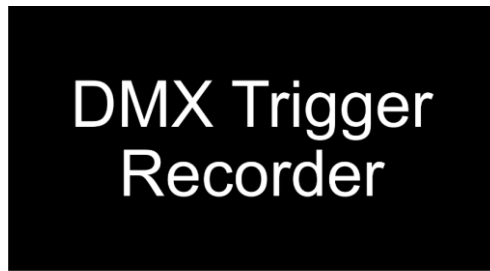

02) If you now press an external trigger button or press the **UP/DOWN** buttons, the device will show the currently active trigger's status. Press the **UP/DOWN** buttons to toggle through the 6 triggers:

Trigger Status	
1. Name:	Trigger1
2. Show:	SHT001
3. Time:	00:03
4. Status:	Playing
5. Delay:	00:00

03) In order to return to the start screen (from any place in the menu), press and hold down the **MENU** button for 2 seconds.

04) Press the **MENU** button to enter the main menu. The display will show:

Main Menu	
1. Play Show	
2. Record Show	
3. Delete Show	
4. Trigger Event	
5. Stop TR Event	
6. Device Settings	
7. Save Configuration	
8. Load Configuration	
9. Default Setting	

1. Play Show
2. Record Show
3. Delete Show
4. Trigger Event
5. Stop TR Event
6. Device Settings
7. Save Configuration
8. Load Configuration
9. Default Setting

05) Insert a microSD card into the slot **(01)**.

06) Press the **UP/DOWN** buttons to toggle through the 9 menus.

07) Press the **ENTER** button to open the desired menu.

### 1. Play Show

In this menu you can play the previously recorded shows, as a sort of preview. You can only play one show at a time. All the other active triggered shows and the external triggers will be disabled.

**Note:** Before using this operation mode, you will need to program at least one show. For more information, please read 2. Record Show, page 9.

**Note:** When this mode is active, **remove the DMX cable** from the DMX input connector **(05)**, in order to avoid data collision.

01) The display will show:



- 02) Press the **UP/DOWN** buttons to select SHOW or MODE and press the **ENTER** button.
- 03) If you have chosen SHOW, press the **ENTER** button to open the menu. The display will show the list of all the recorded shows.
- 04) If you have not inserted the microSD card into the slot, the display will show PLEASE INSERT SD-CARD.
- 05) Insert the SD card and press the **ENTER** button to confirm.

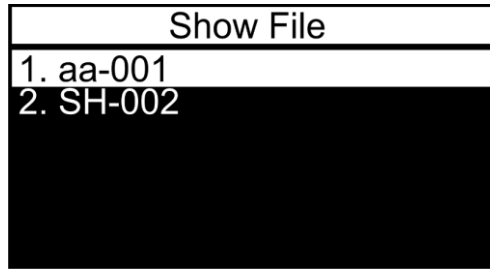

- 06) Press the **UP/DOWN** buttons to select the desired show and press the **ENTER** button to confirm your choice.
- 07) In step 3, if you have chosen MODE, press the **ENTER** button to open the menu.
- 08) Press the **UP/DOWN** buttons to select ONE PLAY (the show will be played once) or LOOP PLAY (the show will be played in a loop). Press the **ENTER** button to confirm your choice.
- 09) Press the **UP/DOWN** buttons to select START PLAY and press the **ENTER** button.
- 10) The device will now play the desired show. The display will show:



- 11) Press the **ENTER** button to stop playback.

## 2. Record Show

In this menu you can record your own shows.

**Note:** It is allowed to connect a light controller to the DMX input connector **(05)** only when using this operation mode.

- 01) The display will show:

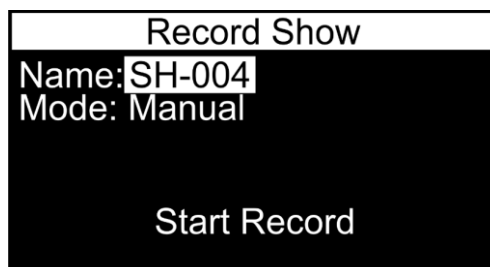

- 02) Press the **UP/DOWN** buttons to select NAME or MODE and press the **ENTER** button.
- 03) If you have chosen NAME, press the **ENTER** button to open the menu and edit the name of the show. The display will show:

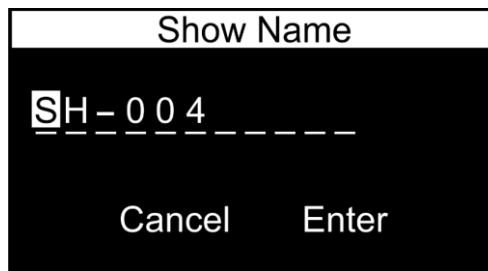

- 04) Press the **UP/DOWN** buttons to select the character which you would like to edit and press the **ENTER** button.
- 05) Press (or press and hold down, for quick search) the **UP/DOWN** buttons to select the desired character and press the **ENTER** button to confirm your choice. Repeat this step to edit the other characters.
- 06) Once you have renamed the file, press the **UP/DOWN** buttons to select CANCEL (to discard changes) or ENTER (to confirm the new file name). Press the **ENTER** button to confirm your choice.
- 07) In step 2, if you have chosen MODE, press the **ENTER** button to open the menu and select the desired recording mode. There are 3 options:
  - MANUAL: manually start and stop recording
  - SEMI\_AUTO: recording starts when the value of a DMX channel is higher than 0. When the DMX channel values are set to 0, or Blackout on the light controller is active, the recording will not start. Once a recording has started, it needs to be stopped manually by choosing STOP RECORD.
  - AUTO: recording starts when the value of a DMX channel is higher than 0. The recording can be stopped by setting all DMX channel values to 0 or by activating Blackout on the light controller.
- 08) Once you have chosen the desired option, press the **ENTER** button to confirm your choice.
- 09) Press the **UP/DOWN** buttons to select START RECORD and press the **ENTER** button to confirm.
- 10) If the display shows WAITING START, press the **ENTER** button again to confirm and start recording.
- 11) Press the **ENTER** button to stop recording. The recorded show will now be saved.

### 3. Delete Show

In this menu you can remove the previously recorded shows.

01) The display will show:

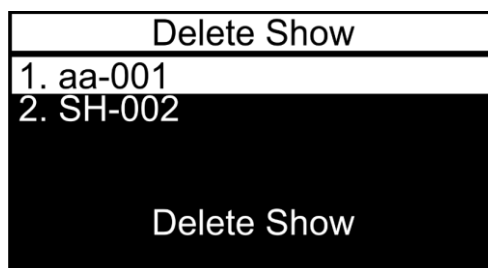

- 02) Press the **UP/DOWN** buttons to select the show which you would like to delete.
- 03) Press the **ENTER** button to confirm your choice. DELETE SHOW will illuminate.
- 04) Press the **ENTER** button to delete the show.
- 05) Repeat steps 2-4 to delete other shows.
- 06) If the show which you wish to delete is assigned to any active trigger event, the device will inform you about this fact. Press the **UP/DOWN** buttons to choose CONTINUE (to delete the show) or RETURN (to return to the previous menu) and press the **ENTER** button to confirm your choice.

#### 4. Trigger Event

In this menu you can set the trigger event settings. It is possible to activate multiple triggers at a time.

01) The display will show:

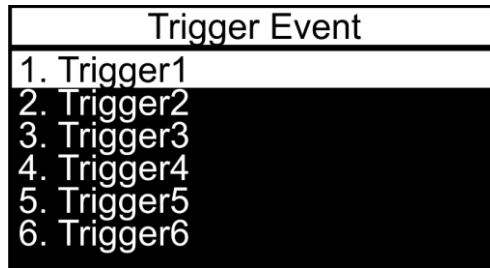

02) Press the **UP/DOWN** buttons to select the desired trigger and press the **ENTER** button to open the desired menu. The display will show:

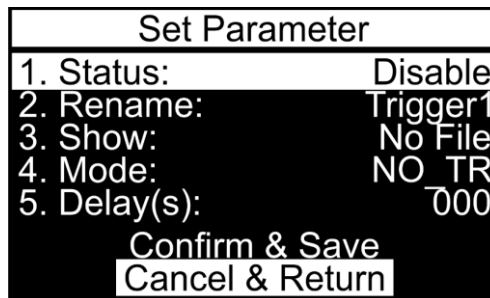

03) Press the **UP/DOWN** buttons to toggle through the 5 available submenus:

- STATUS
- RENAME
- SHOW
- MODE
- DELAY

04) Press the **ENTER** button to open the desired submenu.

##### 4.1. Status

In this menu you can activate/deactivate the desired trigger event.

01) Once you have entered the menu, press the **UP/DOWN** buttons to select ENABLE or DISABLE.

02) Press the **ENTER** button to confirm your choice.

##### 4.2. Rename

In this menu you can rename the trigger events.

01) Once you have entered the menu, the display will show:

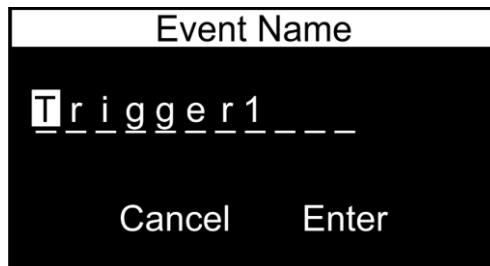

02) Press the **UP/DOWN** buttons to select the character which you would like to edit and press the **ENTER** button.

03) Press (or press and hold down, for quick search) the **UP/DOWN** buttons to select the desired character and press the **ENTER** button to confirm your choice. Repeat this step to edit the other characters.

04) Once you have renamed the trigger event, press the **UP/DOWN** buttons to select CANCEL (to discard changes) or ENTER (to confirm the new name). Press the **ENTER** button to confirm your choice.

**4.3. Show**

In this menu you can assign your recorded shows to the desired triggers.

01) Once you have entered the menu, press the **UP/DOWN** buttons to select the desired show.

Show File	
1.	aa-001
2.	SH-002

02) Press the **ENTER** button to confirm your choice.

**4.4. Mode**

In this menu you can set the trigger mode.

01) Once you have entered the menu, press the **UP/DOWN** buttons to select one of the 4 modes:

- **NO\_TR:** Normally Open (Trigger will be activated when the circuit closes. As long as the circuit remains closed, the triggered show will play in a loop. When the circuit opens, the show will keep playing until it ends and then it will stop. With only a short pulse, the show will play just once.)
- **NC\_TR:** Normally Closed (Trigger will be activated when the circuit opens. As long as the circuit remains open, the triggered show will play in a loop. When the circuit closes, the show will keep playing until it ends and then it will stop. With only a short pulse, the show will play just once.)
- **TOGGLE\_TR:** It works with NO and NC circuits (external buttons). The first pulse starts the triggered show to play in a loop. After the second pulse, the show will stop. Another pulse will restart the show.
- **AUTO\_TR:** When set to this mode, the trigger will be activated immediately. Upon every start-up, the device will always search for any triggers set to this mode and will activate them.

02) Press the **ENTER** button to confirm your choice.

03) It is possible to use each of the 4 modes at the same time, independently, for separate triggers (1-6).

**4.5. Delay**

In this menu you can set the delay time.

01) Once you have entered the menu, press the **UP/DOWN** buttons to set the delay time. The adjustment range is between 0-120 seconds.

02) Press the **ENTER** button to save changes.

**Note:** Once you have adjusted all the options 4.1-4.5, press the **UP/DOWN** buttons to select CONFIRM & SAVE (to save a new trigger event) or CANCEL & RETURN (to discard changes and return to the previous menu). Press the **ENTER** button to confirm your choice.

**5. Stop TR Event**

In this menu you can deactivate the desired trigger events.

01) The display will show:

Stop TR Event	
1. Trigger1:	Playing
2. Trigger2:	Playing
3. Trigger3:	Stop
4. Trigger4:	Stop
5. Trigger5:	Stop
6. Trigger6:	Stop

02) Press the **UP/DOWN** buttons to select the desired trigger event.

03) Press the **ENTER** button to deactivate the selected trigger event.

04) Repeat steps 2-3 to deactivate the remaining trigger events.

## 6. Device Settings

In this menu you can set the device's settings.

01) The display will show:

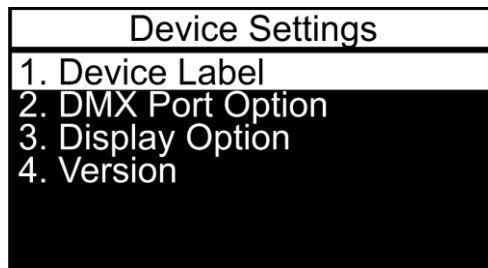

02) Press the **UP/DOWN** buttons to toggle through the 4 available submenus:

- DEVICE LABEL
- DMX PORT OPTION
- DISPLAY OPTION
- VERSION

03) Press the **ENTER** button to open the desired submenu.

### 6.1. Device Label

In this menu you can rename the device label.

01) Once you have entered the menu, the display will show:

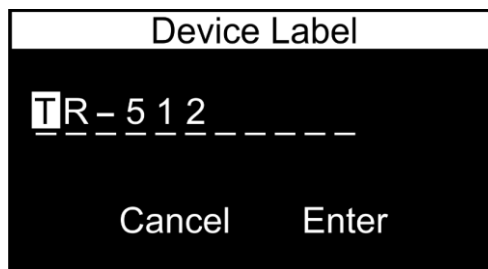

02) Press the **UP/DOWN** buttons to select the character which you would like to edit and press the **ENTER** button.

03) Press (or press and hold down, for quick search) the **UP/DOWN** buttons to select the desired character and press the **ENTER** button to confirm your choice. Repeat this step to edit the other characters.

04) Once you have renamed the device label, press the **UP/DOWN** buttons to select CANCEL (to discard changes) or ENTER (to confirm the new name). Press the **ENTER** button to confirm your choice.

### 6.2. DMX Port Option

In this menu you can set the port settings.

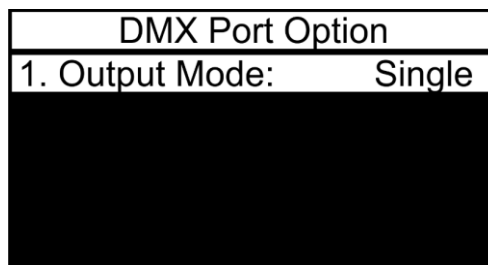

01) Once you have entered the menu, press the **ENTER** button to open edition mode.

02) Press the **UP/DOWN** buttons to select one of the 2 modes:

- SINGLE: only the last triggered show will be played
- HTP (Highest Takes Precedence): all triggered shows can be played simultaneously. The DMX values of each DMX channel are compared for all the triggered shows and they become merged into a DMX output signal, which contains only the highest value for each DMX channel.

03) Press the **ENTER** button to confirm your choice.

### 6.3. Display Option

In this menu you can set the display options.

Display Option	
1. Mode:	Normal
2. GoBack(s):	25
3. BackLight(s):	30

01) Press the **UP/DOWN** buttons to select one of the 3 modes:

- **MODE:** choose between **NORMAL** (normal view) and **INVERSE** (display flip). If you have chosen **INVERSE**, the button functions (**MENU/UP/DOWN/ENTER**) will flip accordingly, too.
- **GOBACK(S):** set the time which needs to pass, after which the display returns to the start screen, when no button is pressed; the adjustment range is between **NEVER** and 5-60 seconds
- **BACKLIGHT(S):** set the time which needs to pass, after which the display will turn off; the adjustment range is between **ON** and 5-60 seconds

02) Press the **ENTER** button to open the desired submenu.

03) Press the **UP/DOWN** buttons to adjust settings.

04) Press the **ENTER** button to save changes.

### 6.4. Version

In this menu you can view the current software version.

Version
CPU1:B1.0 V1.7

## 7. Save Configuration

In this menu you can create a configuration backup.

01) The display will show:

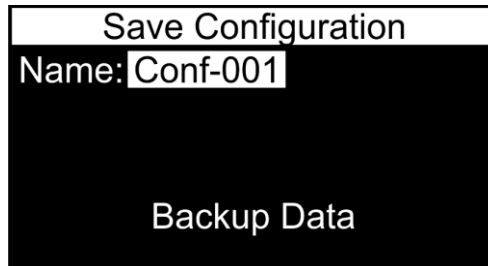

02) Once you have entered the menu, press the **UP/DOWN** buttons to select NAME and press the **ENTER** button to open name edition menu. The display will show:

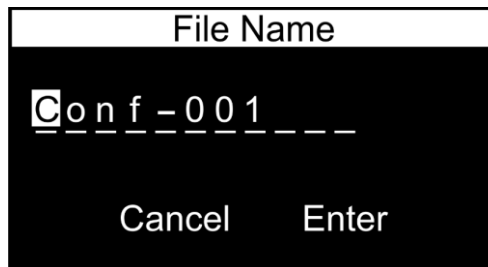

- 03) Press the **UP/DOWN** buttons to select the character which you would like to edit and press the **ENTER** button.
- 04) Press (or press and hold down, for quick search) the **UP/DOWN** buttons to select the desired character and press the **ENTER** button to confirm your choice. Repeat this step to edit the other characters.
- 05) Once you have renamed the configuration file, press the **UP/DOWN** buttons to select CANCEL (to discard changes) or ENTER (to confirm the new name). Press the **ENTER** button to confirm your choice.
- 06) Now press the **UP/DOWN** buttons to select BACKUP DATA and press the **ENTER** button to create a configuration backup. The display will show:



07) Press the **ENTER** button to return to the main menu.



## 8. Load Configuration

In this menu you can load or delete your configuration backup files.

01) The display will show:

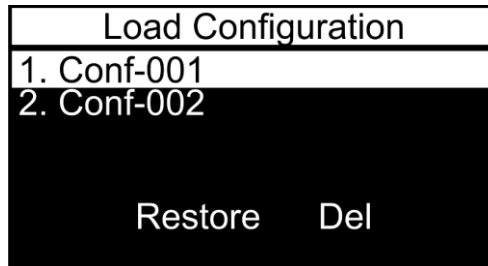

- 02) Press the **UP/DOWN** buttons to select the desired configuration backup file. Press the **ENTER** button to confirm your choice.
- 03) Press the **UP/DOWN** buttons to choose between RESTORE (load the desired configuration backup file) and DEL (delete the desired configuration backup file). Press the **ENTER** button to confirm your choice. Alternatively, press the **MENU** button if you do not want to use those functions and you want to return to the previous menu.

## 9. Default Setting

In this menu you can restore default settings.

01) Once you have entered the menu, the display will show:

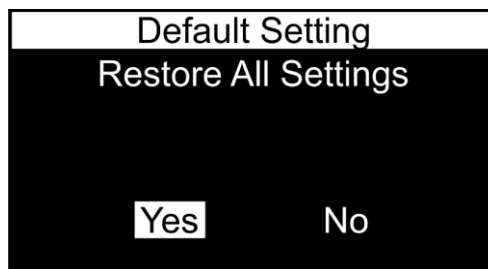

- 02) Press the **UP/DOWN** button to choose between YES and NO. Press the **ENTER** button to confirm your choice.
- 03) If you have chosen NO, the display will return to the main menu.
- 04) If you have chosen YES, the default settings will be restored (All settings of the current trigger events and all the display options will be set to default. The DMX PORT OPTION will be set to SINGLE.)
- 05) All saved shows and configuration files will remain intact.
- 06) The display will return to the main menu.



**The TR-512 should be turned off, before removing the micro SD card.  
The included micro SD card can be used to back up your data and transfer your files to a regular PC.**



## RJ45 Connector

Please follow the instructions below in order to create an RJ45 trigger connector.

### Pinout

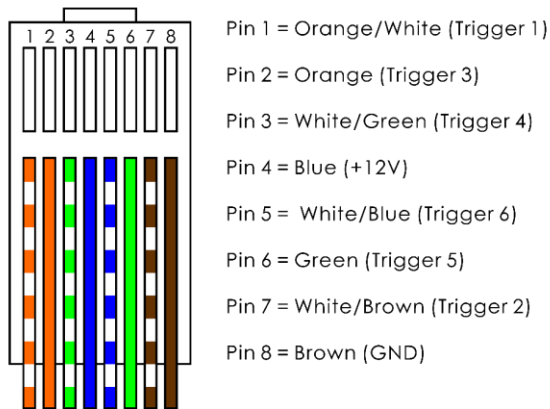

### Trigger Connection

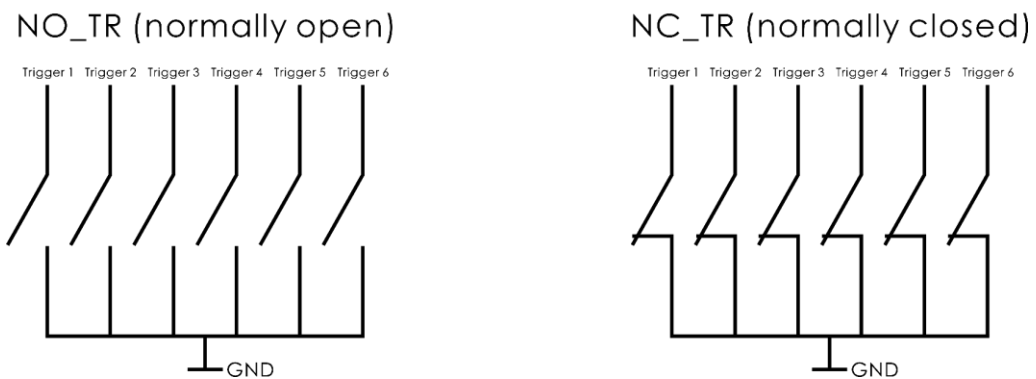

Fig. 04

It is possible to use each of the 4 modes (NO\_TR, NC\_TR, TOGGLE\_TR, AUTO\_TR) independently, for separate triggers (1-6). Make sure that your settings are correct (see 4.4, page 12).

## Installation of the TR-512 Wallpanel RJ45 (ordercode: 50824)

It is possible to use the TR-512 Wallpanel in order to trigger programs.

### Overview

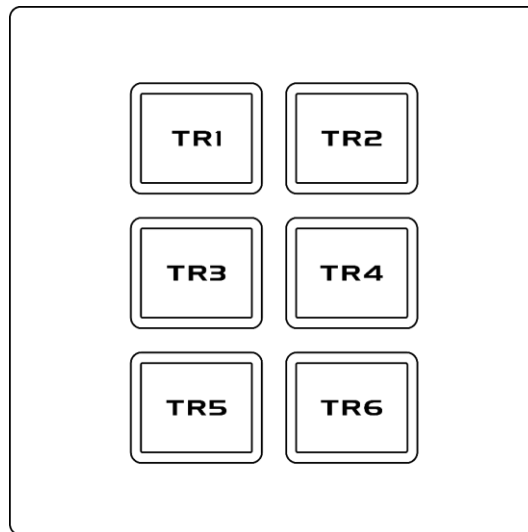

Fig. 05

### Backside

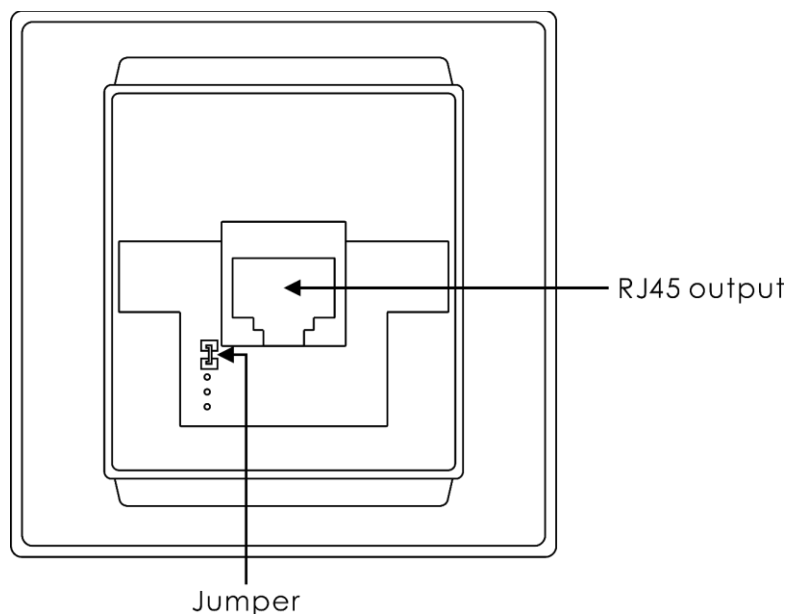

Fig. 06

- 01) Connect the Wallpanel to the TR-512 trigger by means of a CAT cable. **Recommended maximum CAT cable length: 25 m.**
- 02) You can install the Wallpanel in two ways, **with or without the jumper**. Please, see Fig. 06 above.
  - **With** the jumper: the TR-512 trigger should be set to **TOGGLE\_TR**. Press one of the 6 trigger buttons on the Wallpanel to run a program. Press the button again to immediately stop the program. See 4.4. Mode (page 12) for more information.
  - **Without** the jumper: the TR-512 trigger should be set to **NO\_TR**. Press one of the 6 trigger buttons on the Wallpanel to run a program. If you press the button again, the device will wait until the currently active program reaches its end and then it will stop. See 4.4. Mode (page 12) for more information.
- 03) Press the trigger buttons to activate/deactivate desired programs. The corresponding trigger button will light up when active.

## Maintenance

---

The operator has to make sure that safety-related and machine-technical installations are to be inspected by an expert after every year in the course of an acceptance test.

The operator has to make sure that safety-related and machine-technical installations are to be inspected by a skilled person once a year.

The Showtec TR-512 requires almost no maintenance. However, you should keep the unit clean. Disconnect the mains power supply and then wipe the cover with a damp cloth. Do not use alcohol or solvents. Do not immerse in liquid. Keep connections clean. Disconnect electric power, and then wipe the DMX connections with a damp cloth. Make sure connections are thoroughly dry before linking equipment or supplying electric power.

The following points have to be considered during the inspection:

- 01) All screws used for installing the device or parts of the device have to be tightly connected and must not be corroded.
- 02) There may not be any deformations on housings, fixations and installation spots.
- 03) The electric power supply cables must not show any damages or material fatigue.

## Troubleshooting

---

### No Light

This troubleshooting guide is meant to help solve simple problems.

If a problem occurs, carry out the steps below in sequence until a solution is found. Once the unit operates properly, do not carry out following steps.

If the DMX trigger or the light effect does not operate properly, refer servicing to a technician.

Suspect four potential problem areas as: the power supply, the DMX trigger, the Wallpanel and the light fixture.

- 01) Power supply. Check if the unit is plugged into an appropriate power supply.
- 02) The DMX trigger. Return the TR-512 to your Showtec dealer.
- 03) The Wallpanel. Return the Wallpanel to your Showtec dealer.
- 04) The light fixture. Return your light fixture to your dealer.
- 05) If all appears to be O.K., plug the unit in again.
- 06) If you are unable to determine the cause of the problem, do not open the TR-512 or the Wallpanel, as this may damage the unit(s) and the warranty will become void.
- 07) Return the device(s) to your Showtec dealer.

### No Response to DMX

Suspect the DMX cable or connectors, a controller malfunction, a light effect DMX card malfunction.

- 01) Check the DMX setting. Make sure that DMX addresses are correct.
- 02) Check the DMX cable: Unplug the unit; change the DMX cable; then reconnect to electrical power. Try your DMX control again.
- 03) Determine whether the DMX trigger, light controller or light effect is at fault. Does the controller operate properly with other DMX products? If not, take the controller in for repair. If so, take the DMX cable and/or the light effect to a qualified technician.

Problem	Probable cause(s)	Remedy
The device does not function at all	No power to the device	<ul style="list-style-type: none"> <li>• Check if power is switched on and cables are plugged in</li> </ul>
Fixtures reset correctly, but all respond erratically or not at all to the controller	The controller is not connected 3-pin XLR Out of the DMX trigger does not match XLR Out of the fixture on the link (i.e. signal is reversed)	<ul style="list-style-type: none"> <li>• Connect controller</li> <li>• Install a phase reversing cable between the controller and the first fixture on the link</li> </ul>
Fixtures reset correctly, but some respond erratically or not at all to the DMX trigger	Poor data quality	<ul style="list-style-type: none"> <li>• Check data quality. If much lower than 100 percent, the problem may be a bad data link connection, poor quality or broken cables, missing termination plug, or a defective fixture disturbing the link</li> </ul>
	Bad data link connection	<ul style="list-style-type: none"> <li>• Inspect connections and cables. Correct poor connections. Repair or replace damaged cables</li> </ul>
	Data link not terminated with 120 Ohm termination plug	<ul style="list-style-type: none"> <li>• Insert termination plug in output jack of the last fixture on the link</li> </ul>
	Incorrect addressing of the fixtures 3-pin XLR Out on the fixtures does not match (pins 2 and 3 reversed)	<ul style="list-style-type: none"> <li>• Check address setting</li> <li>• Install a phase-reversing cable between the fixtures or swap pins 2 and 3 in the fixture</li> </ul>
No light or LEDs/lamp cuts out intermittently	Fixture is too hot	<ul style="list-style-type: none"> <li>• Allow fixture to cool down</li> <li>• Turn up the air conditioning</li> </ul>
	LEDs/lamp damaged	<ul style="list-style-type: none"> <li>• Disconnect fixture and return to your dealer</li> </ul>
	The power supply settings do not match local AC voltage and frequency	<ul style="list-style-type: none"> <li>• Disconnect fixture. Check settings and correct if necessary</li> </ul>

## Product Specifications

Model:	Showtec TR-512
Input voltage:	100-240V AC, 50/60 Hz
Power supply:	12V DC via the included power adapter, 1500mA
Dimensions (TR-512):	115 x 67 x 45 mm (LxWxH)
Dimensions (Wallpanel):	85 x 85 x 36 mm (LxWxH)
Weight (TR-512):	0,4 kg
Weight (Wallpanel):	0,1 kg
<b>Operation and Programming</b>	
Signal pin OUT:	pin 1 GND, pin 2 (-), pin 3 (+)
Setup:	LCD display for easy setup
Signal input:	3-pin XLR IN
Signal output:	3-pin XLR OUT
<b>Electro-mechanical effects</b>	
Control protocol:	DMX-512
Connections:	3-pin XLR IN & OUT, microSD card IN, trigger RJ45 IN (do not use for data transmission)
Storage:	MicroSD card (included)
Housing:	Aluminum extrusion
IP rating:	IP20
Max. ambient temperature $t_a$ :	40°C
Max. housing temperature $t_B$ :	80°C

Design and product specifications are subject to change without prior notice.



Website: [www.Showtec.info](http://www.Showtec.info)  
 Email: [service@highlite.com](mailto:service@highlite.com)

## Dimensions

### 50825 – TR-512

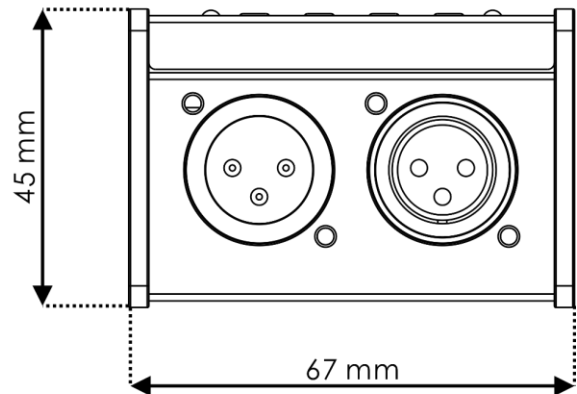
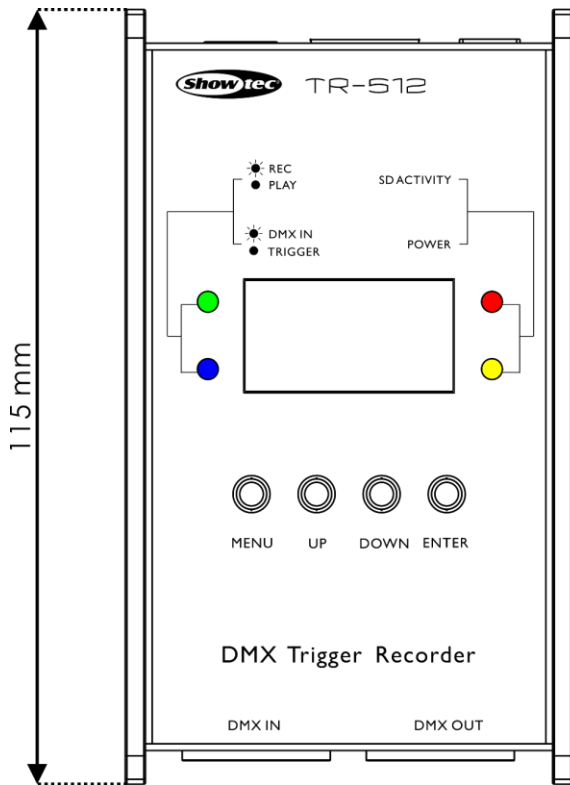

### 50824 – TR-512 Wallpanel (RJ45)

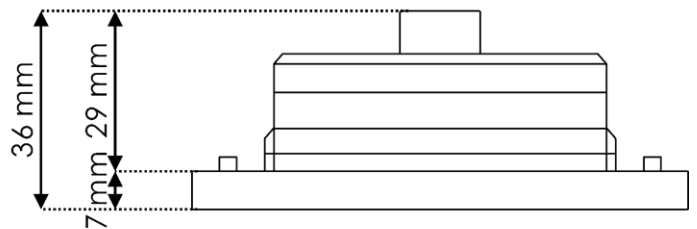
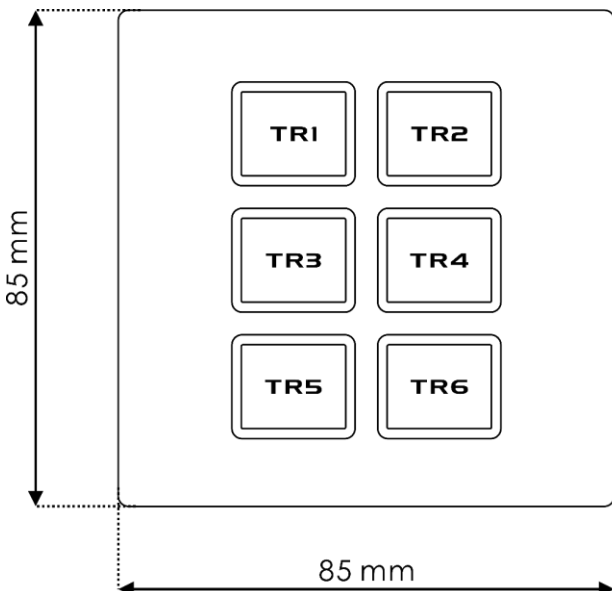



©2018 Showtec