

# COMPACT A 15

## TWO-WAY PROFESSIONAL SPEAKER

### DESCRIPTION

COMPACT A 15 is a multipurpose two-way full-range professional speaker system, suitable for a wide range of applications, such as live sound reinforcement and stage monitoring as well as distributed sound systems for clubs or music venues. The combination of a 1.75" compression driver, 15" woofer, and the constant directivity True Resistive Waveguide produces coherent 100° x 60° coverage for the listening area with high SPL, distortion-free sound. The sleek and lightweight cabinet uses a special polypropylene composite material with an M-brace internal reinforcement, making it easy to carry and secure to install on a pole, flown-, wall-, or truss-mounted using the multiple rigging points and available accessories.



### FEATURES

- 450 W power handling
- Up to 130 dB Sound Pressure Level
- 50-20000 Hz linear frequency response
- 1.75" Compression Driver
- 15" High Power Woofer
- Robust composite material cabinet
- Steel full front grille
- Optional mounting accessories
- 2 x SPEAKON connectors

## TECHNICAL SPECIFICATIONS

<b>Acoustical specifications</b>	Frequency Response (-10dB):	50 Hz ÷ 20000 Hz
	Max SPL @ 1m:	130 dB
	Horizontal coverage angle:	100°
	Vertical coverage angle:	60°
	System Sensitivity:	98 dB
<b>Power section</b>	Amplification:	Full Range
	Nominal Impedance:	8 ohm
	Power Handling:	450 W
	Peak Power Handling:	1800 W PEAK
	Recommended Amplifier:	900 W
	Protections:	Dynamic Active Mosfet
	Crossover Frequencies:	1200 Hz
<b>Transducers</b>	Compression Driver:	1.0", 1.75" v.c
	Woofers:	15", 3.0" v.c
<b>Input/Output section</b>	Input connectors:	Speakon
	Output connectors:	Speakon
<b>Standard compliance</b>	CE marking:	Yes
<b>Physical specifications</b>	Cabinet/Case Material:	PP Composite
	Hardware:	1 x M10 top, 1 x M10 each side
	Handles:	1 top, 1 each side
	Pole mount/Cap:	Yes
	Grille:	Steel
	Color:	Black
<b>Size</b>	Height:	716.6 mm / 28.21 inches
	Width:	414.9 mm / 16.33 inches
	Depth:	410 mm / 16.14 inches
	Weight:	23.5 kg / 51.81 lbs
<b>Shipping informations</b>	Package Height:	760 mm / 29.92 inches
	Package Width:	475 mm / 18.7 inches
	Package Depth:	470 mm / 18.5 inches
	Package Weight:	25.5 kg / 56.22 lbs

## PART NUMBER

- **13000740**

COMPACT A 15

EAN 8024530019761

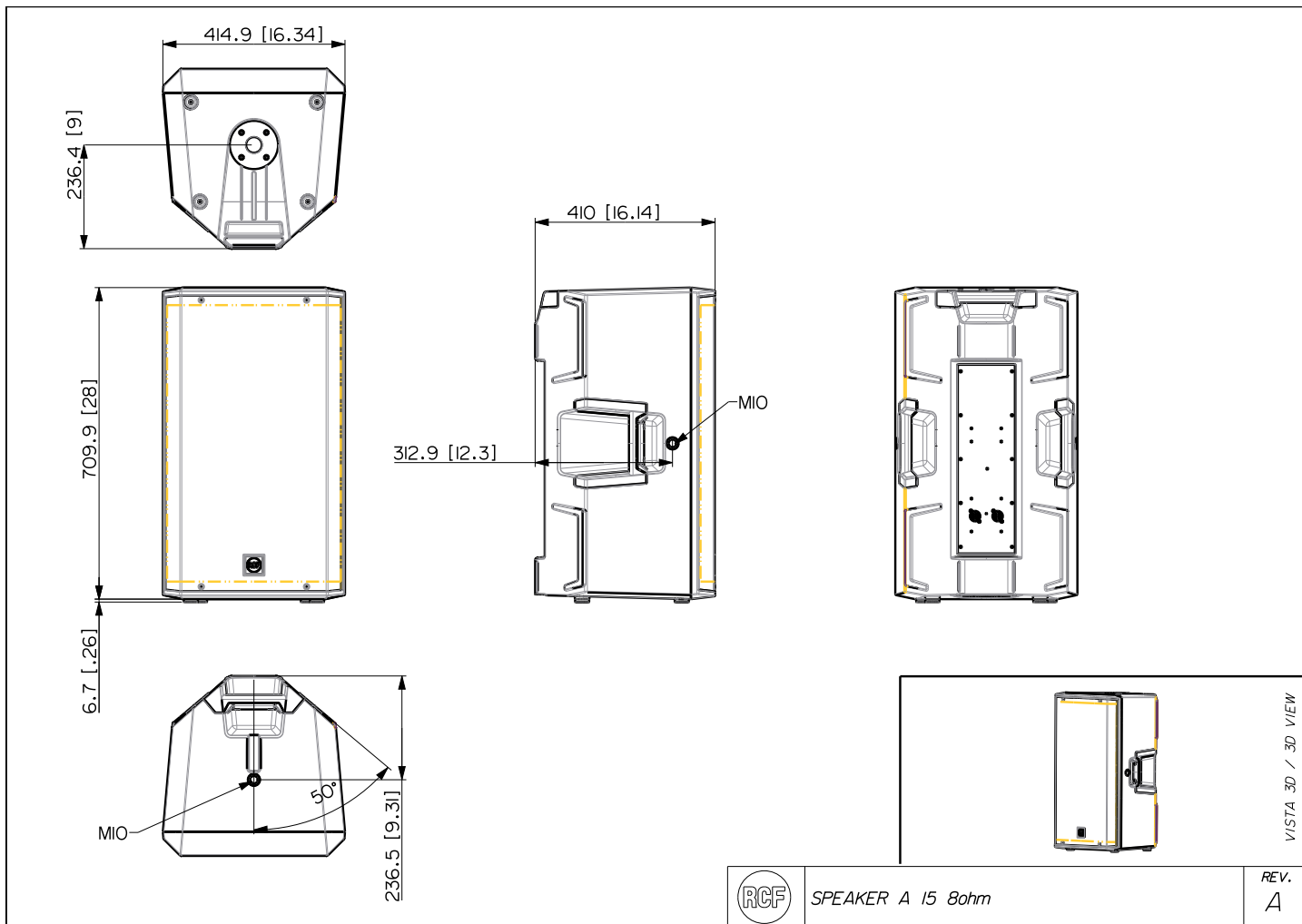

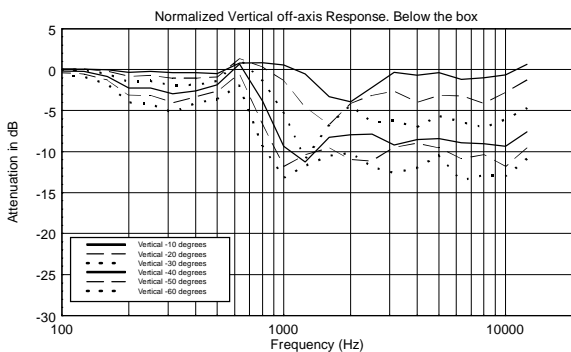
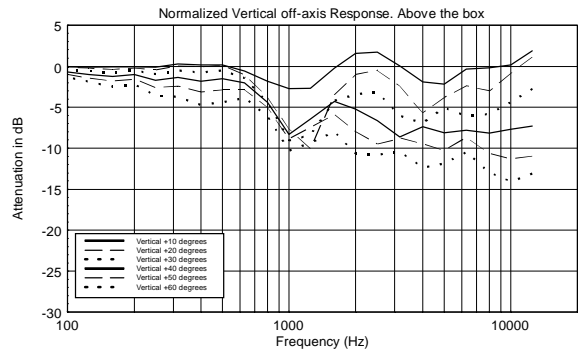
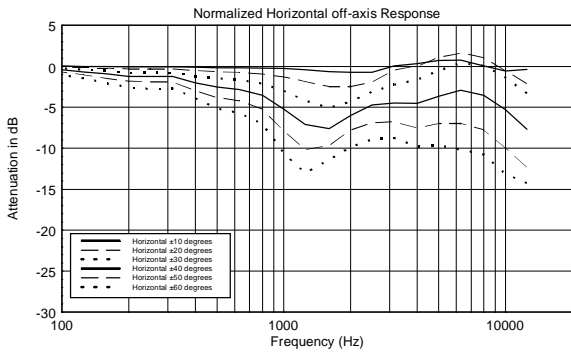
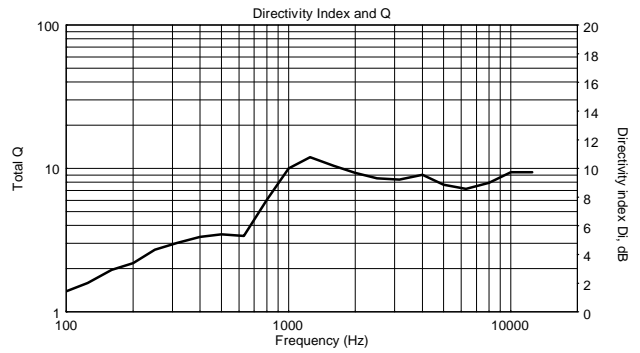
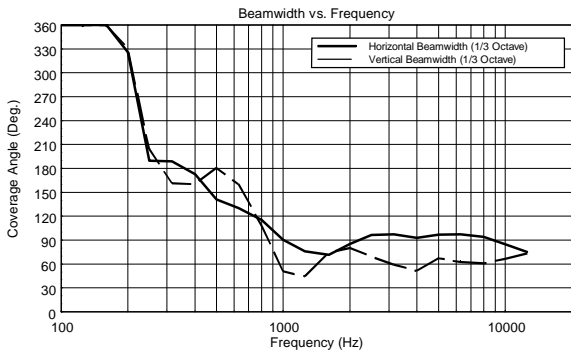
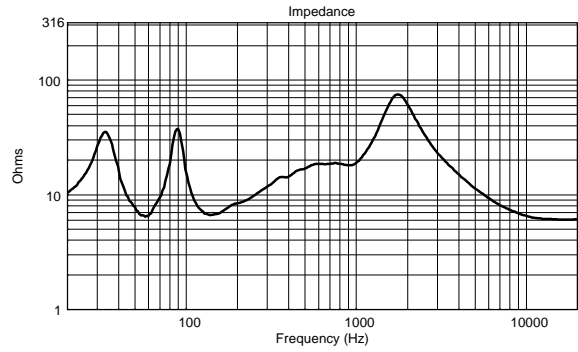
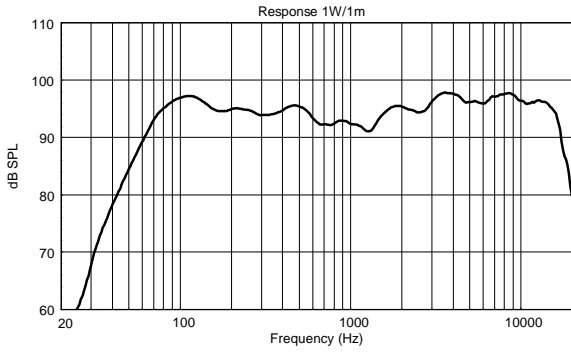

Horizontal 1/3 Octave Polars

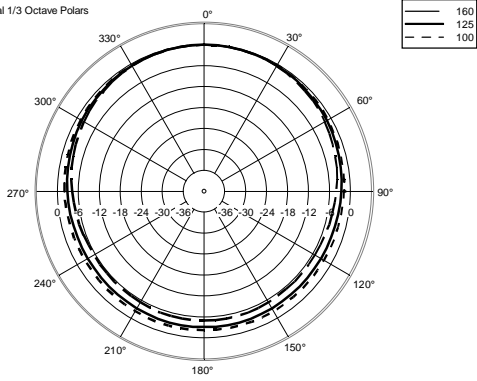

Horizontal 1/3 Octave Polars

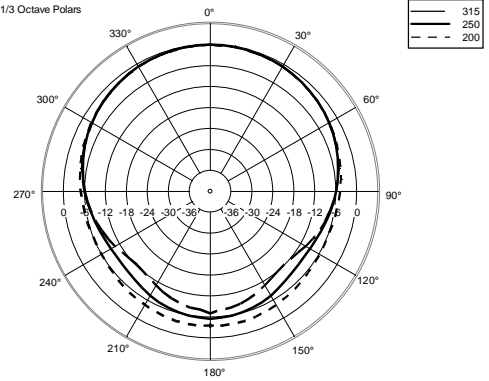

Horizontal 1/3 Octave Polars

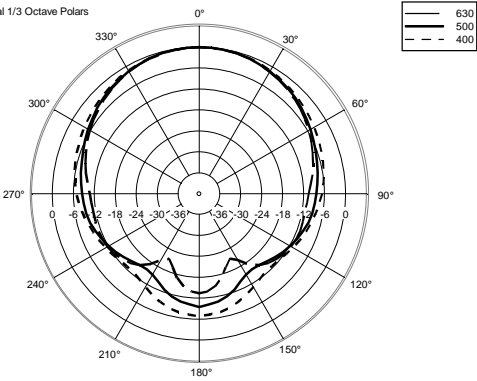

Horizontal 1/3 Octave Polars

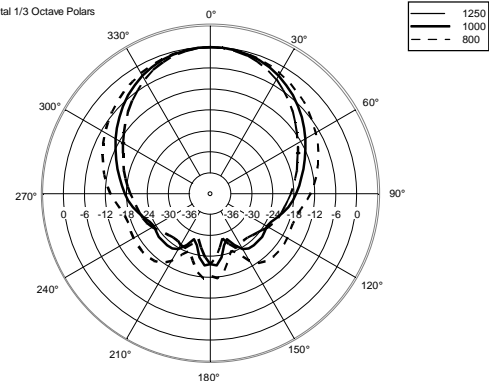

Horizontal 1/3 Octave Polars

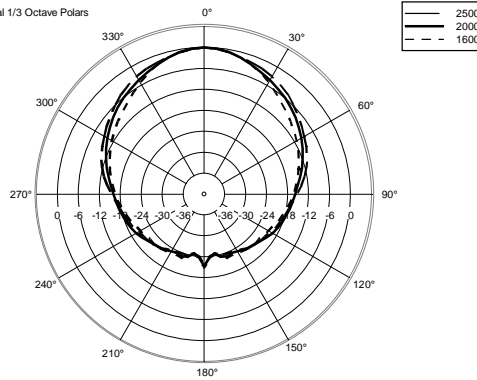

Horizontal 1/3 Octave Polars

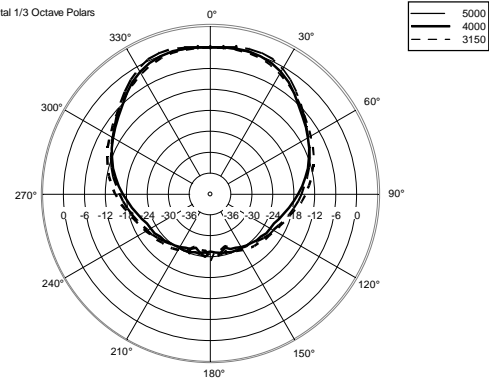

Horizontal 1/3 Octave Polars

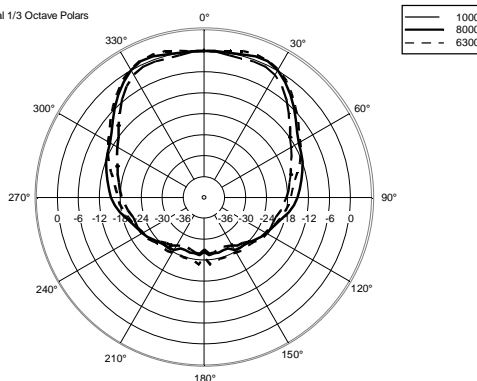



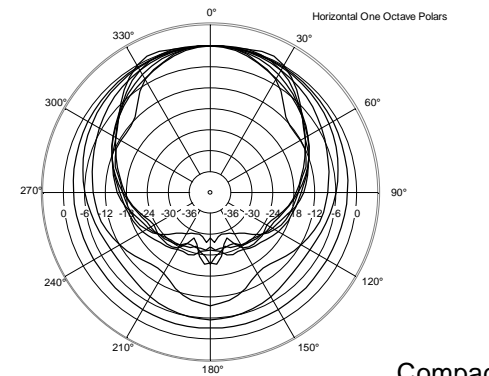

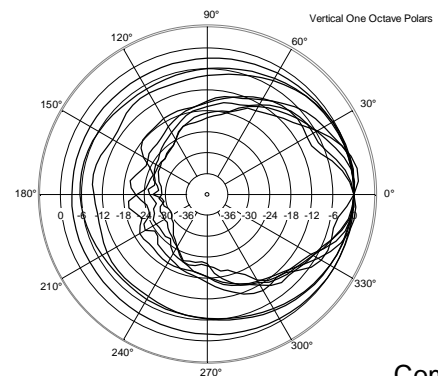
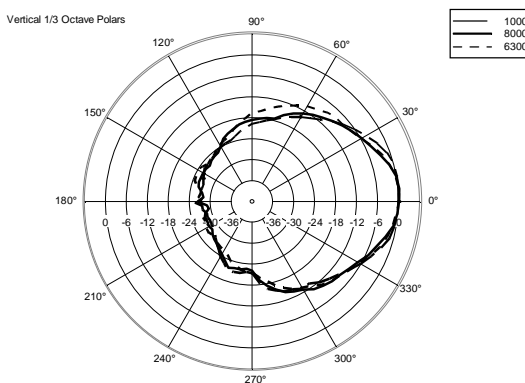
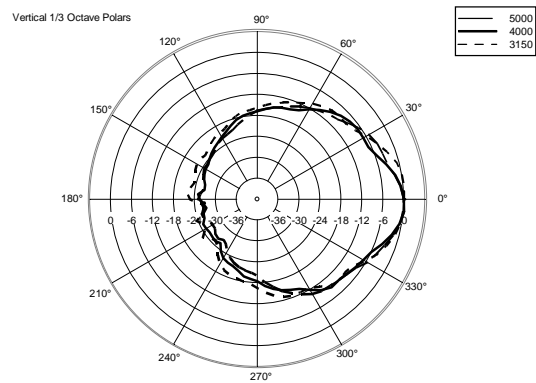
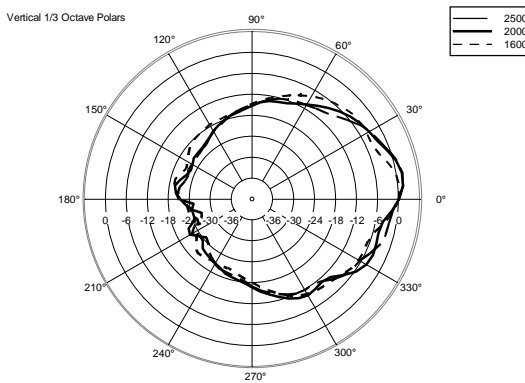
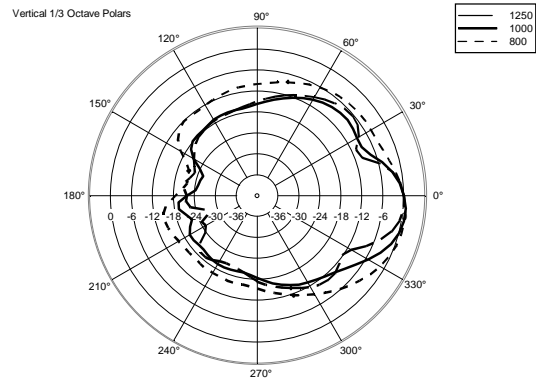
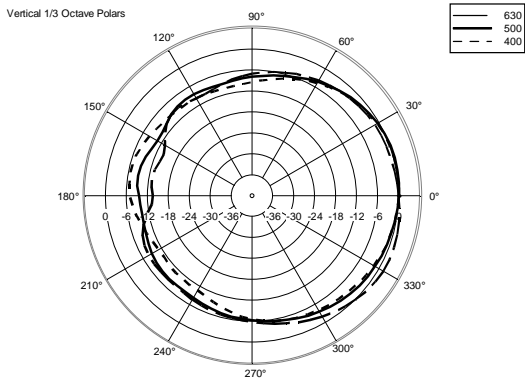
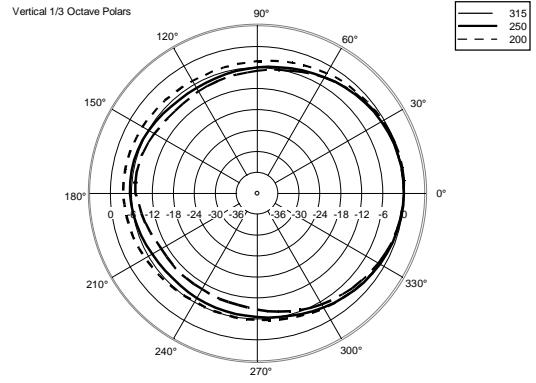
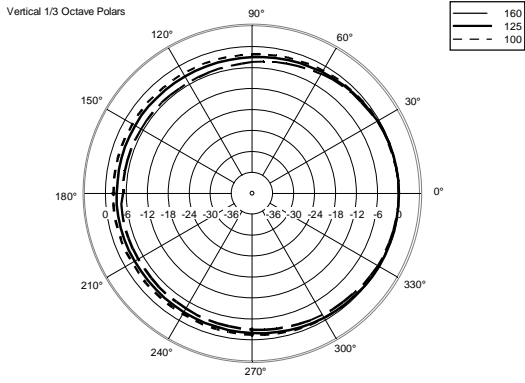



Horizontal One Octave Polars





**ACCESSORIES**

	AC PMA - POLE MOUNT	PART NUMBER EAN:	<b>13360034</b> 8024530007713
	AC PM-M20	PART NUMBER EAN:	<b>13360067</b> 8024530014599
	AC PMX POLE MOUNT M20	PART NUMBER EAN:	<b>13360232</b> 8024530010058
	AC PRO-FS PROFESS. LOCKING FLOOR STAND	PART NUMBER EAN:	<b>13360109</b> 8024530006471
	AC PRO-PM PROFESS. LOCKING POLE MOUNT	PART NUMBER EAN:	<b>13360110</b> 8024530006488
	COVER CVR ART 915	PART NUMBER EAN:	<b>13360478</b> 8024530018856
	FLYING BRACKET FL-BR ART 915	PART NUMBER EAN:	<b>13360481</b> 8024530019174
	HORIZONTAL BRACKET H-BR ART 915	PART NUMBER EAN:	<b>13360479</b> 8024530019198
	VERTICAL BRACKET V-BR ART 915	PART NUMBER EAN:	<b>13360480</b> 8024530019181



## **A&E SPECIFICATIONS**

The product shall be a multipurpose two-way full-range professional speaker system, suitable for a wide range of applications, such as live sound reinforcement and stage monitoring as well as distributed sound systems for clubs or music venues. It shall feature high sensitivity, typical of professional audio cabinets, with smooth and wide frequency response, thanks to the wave-guided compression driver. It shall be robust, suitable for transportation and for any working environment. Optional mounting accessories shall be available for wall or ceiling installations.