

COMPACT M 10

TWO-WAY PASSIVE SPEAKER

DESCRIPTION

COMPACT M 10 is a multipurpose two-way full-range speaker system, suitable for a wide range of applications. Its balanced sound is a big asset in near-field applications for the best intelligibility. The M 10 features high sensitivity, typical of professional audio cabinets thanks to the use of oversized magnets and a HI-FI sound quality, with smooth and wide frequency response, thanks to the wave-guided compression driver. The SPL level of low-distortion audio the M 10 can provide goes far beyond expectations of such a compact solution. The elegant and compact design with accurate finishing makes M 10 suitable for almost any environment, even with architectural constraints. Optional mounting accessories allow using M 10 on wall or ceiling installations.



FEATURES

- 300 W AES power handling
- 128 dB max SPL
- 60 ÷ 20000 Hz frequency range
- 90° x 70° constant directivity coverage angle
- 1 x 10" high power woofer
- 1 x 1.4" voice coil compression driver
- High quality plywood cabinet
- Steel front grille with clothing
- Installation points available on rear, top and bottom panels
- 4 pole EUROBLOCK connector (audio input and parallel link output)

TECHNICAL SPECIFICATIONS

Acoustical specifications	Frequency Response (-10dB):	60 Hz ÷ 20000 Hz
	Max SPL @ 1m:	128 dB
	Horizontal coverage angle:	90°
	Vertical coverage angle:	70°
	Directivity index Q:	9
	System Sensitivity:	98 dB
Power section	Nominal Impedance (ohm):	8 ohm
	Power Handling:	300 W RMS
	Peak Power Handling:	1200 W PEAK
	Recommended Amplifier:	600 W
	Protections:	Dynamic active mosfet
	Crossover Frequencies:	1800 Hz
Transducers	Compression Driver:	1 x 1.0", 1.4" v.c
	Nominal Impedance (ohm):	8 ohm
	Input Power Rating:	25 W AES, 50 W PROGRAM POWER
	Sensitivity:	107 dB, 1W @ 1m
	Woofer:	10", 2.5" v.c
	Nominal Impedance (ohm):	8 ohm
	Input Power Rating:	300 W AES, 600 W PROGRAM POWER
Sensitivity:	98 dB, 1W @ 1m	
Input/Output section	Input connectors:	Euroblock
	Output connectors:	Euroblock
Standard compliance	CE marking:	Yes
Physical specifications	Cabinet/Case Material:	Plywood
	Hardware:	8 x M8, 8 x M10
	Grille:	Steel with clothing
	Color:	Black
Size	Height:	510 mm / 20.08 inches
	Width:	295 mm / 11.61 inches
	Depth:	325 mm / 12.8 inches
	Weight:	17 kg / 37.48 lbs
Shipping informations	Package Height:	545 mm / 21.46 inches
	Package Width:	363 mm / 14.29 inches
	Package Depth:	333 mm / 13.11 inches
	Package Weight:	20 kg / 44.09 lbs



PART NUMBER

- **13000595**
COMPACT M 10
Black
EAN 8024530017804

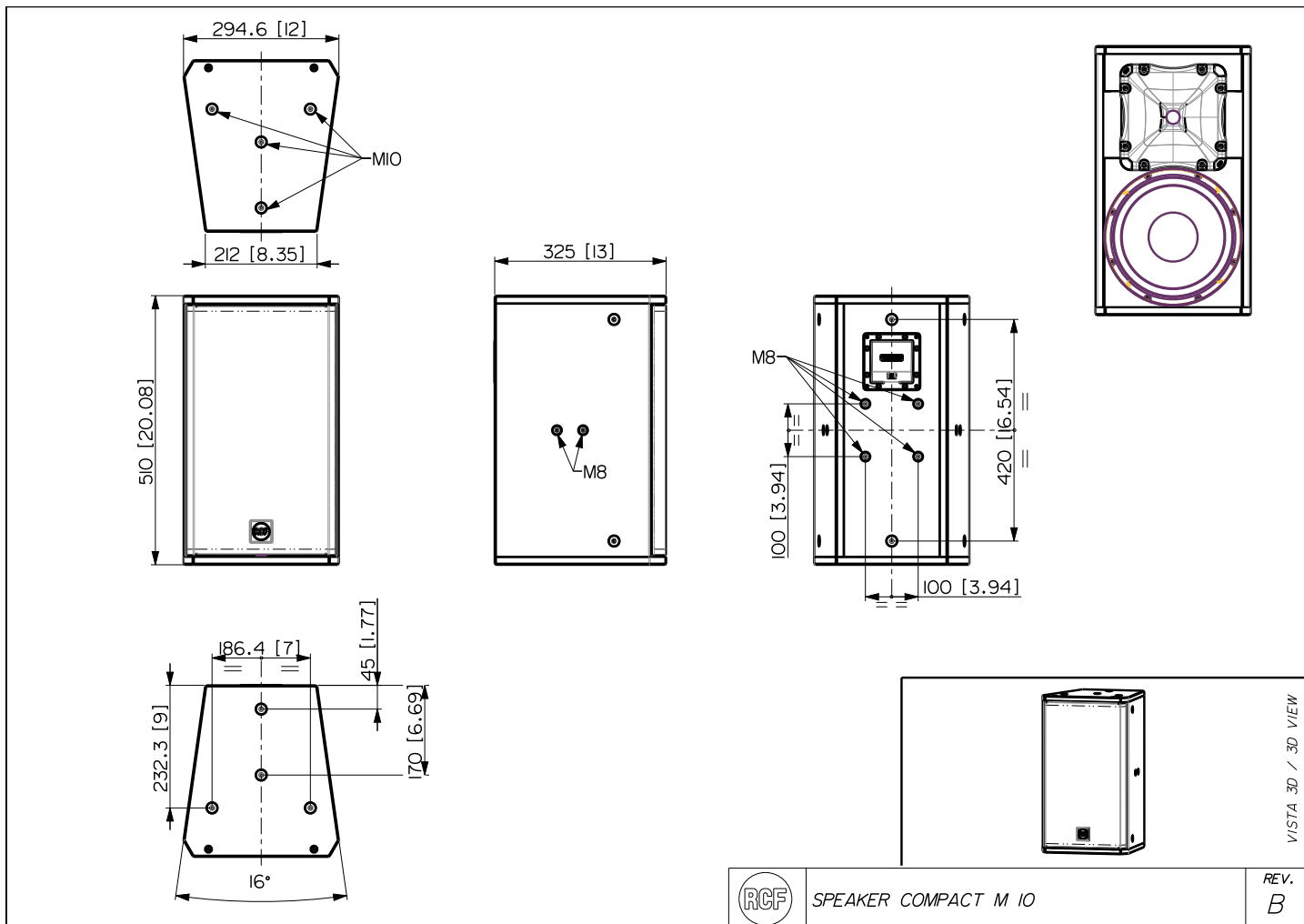

SPEAKER COMPACT M 10

REV.
B

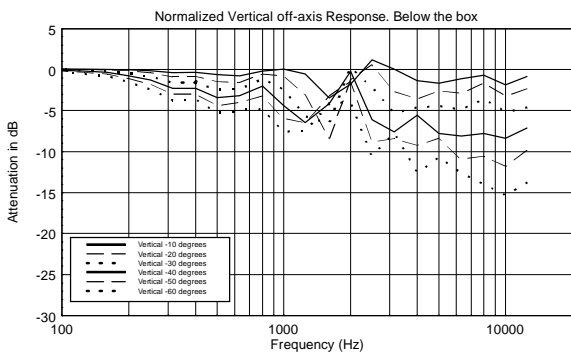
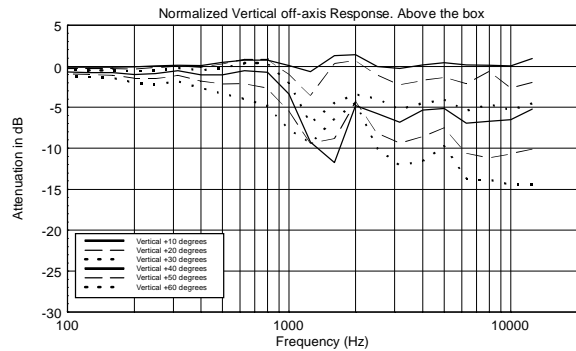
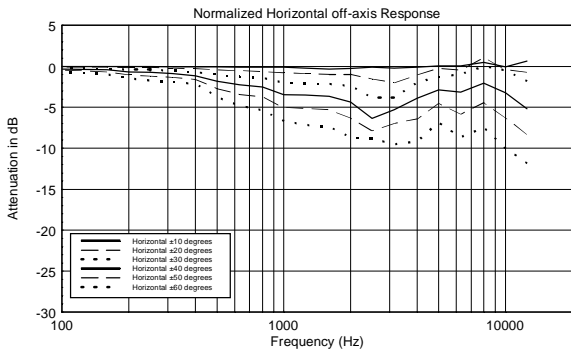
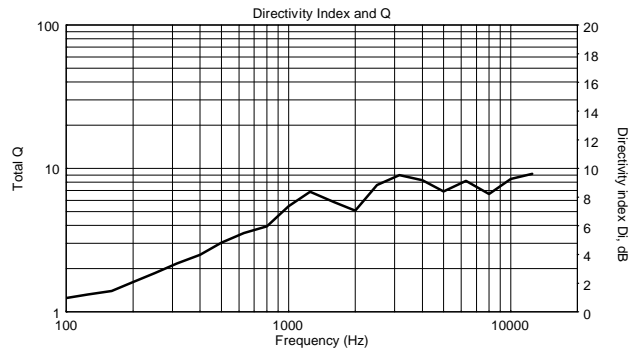
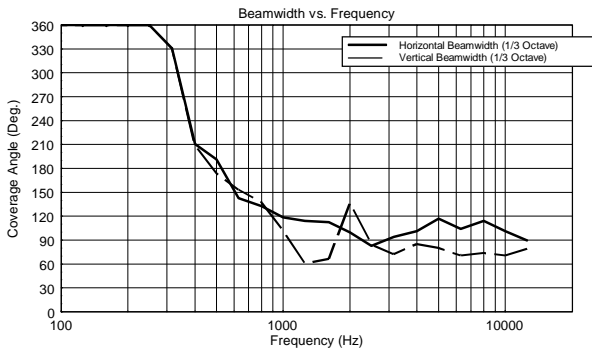
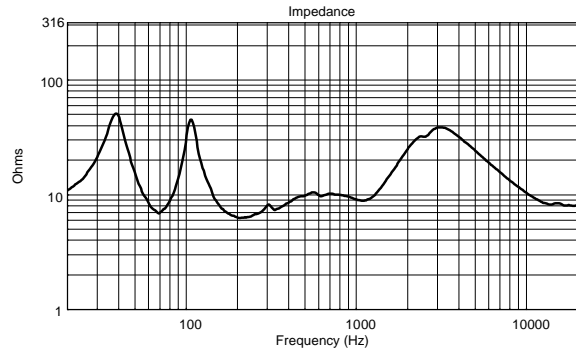
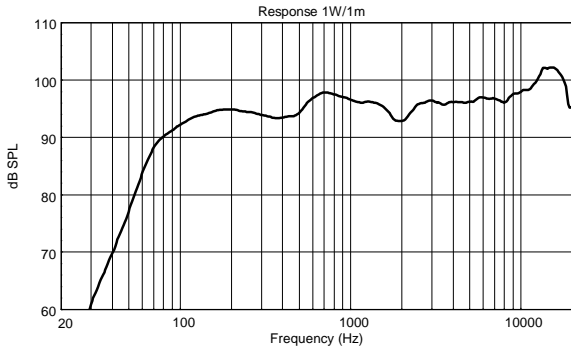

Horizontal 1/3 Octave Polars

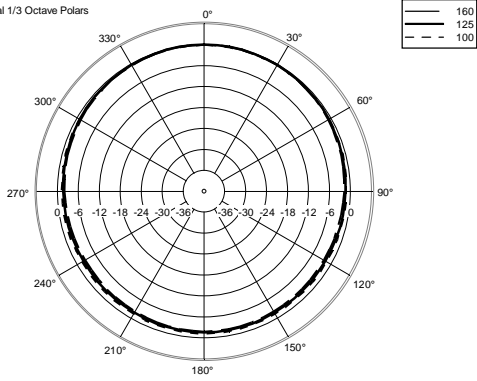

Horizontal 1/3 Octave Polars

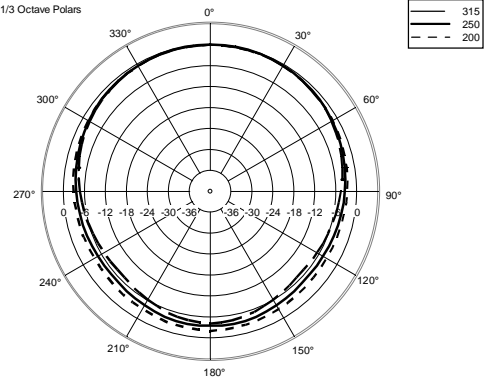

Horizontal 1/3 Octave Polars

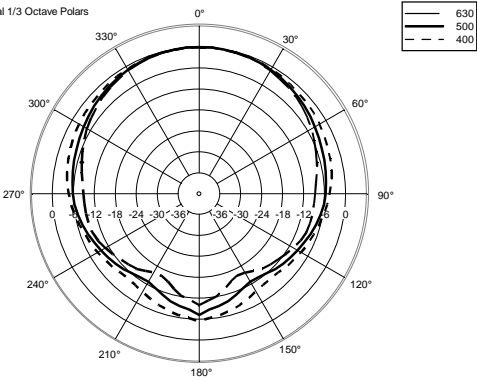

Horizontal 1/3 Octave Polars

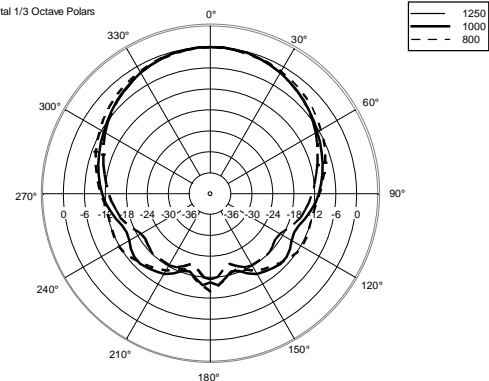

Horizontal 1/3 Octave Polars

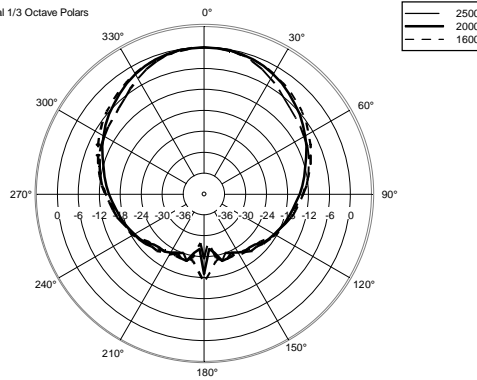

Horizontal 1/3 Octave Polars

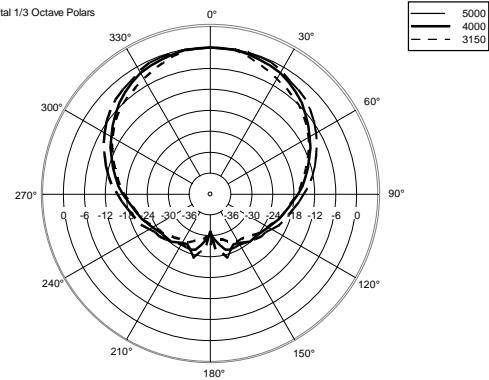

Horizontal 1/3 Octave Polars

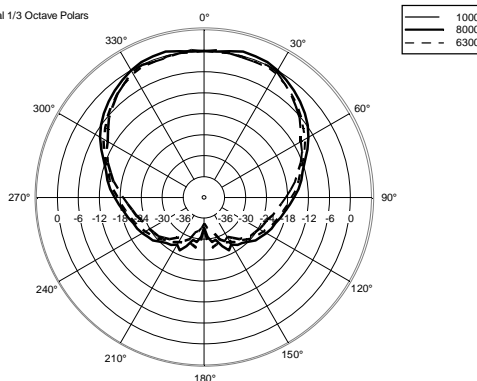

Horizontal One Octave Polars

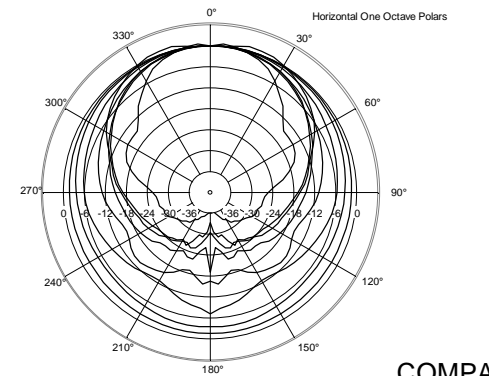

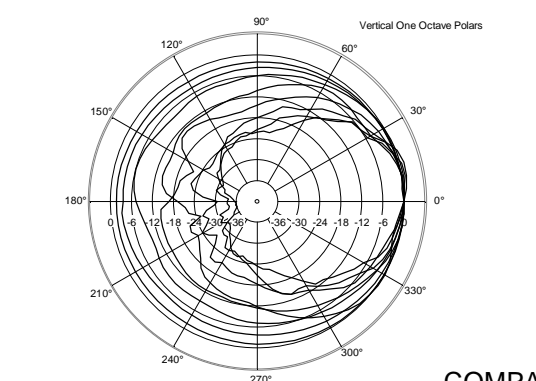
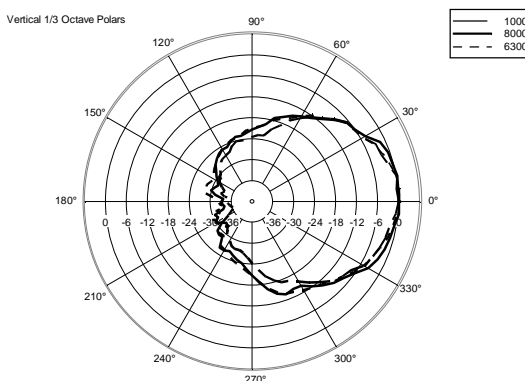
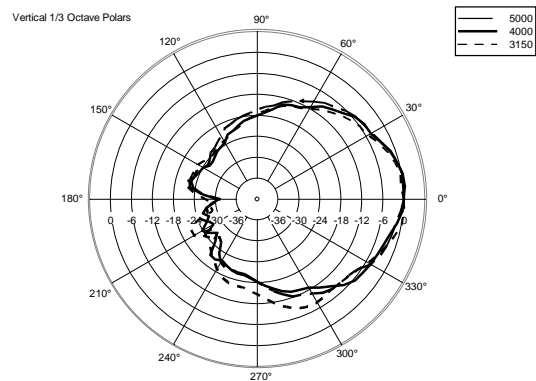
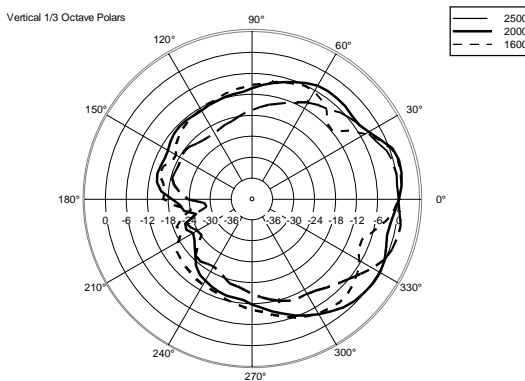
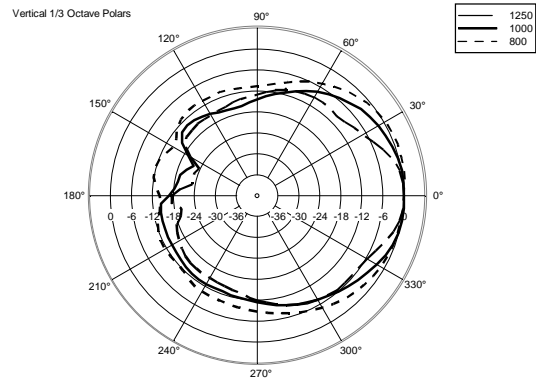
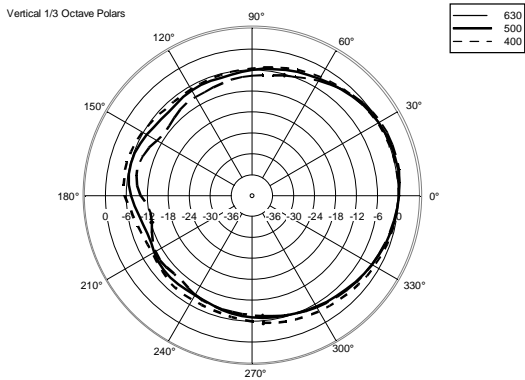
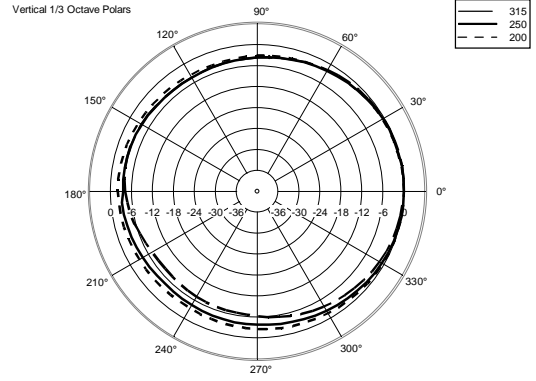
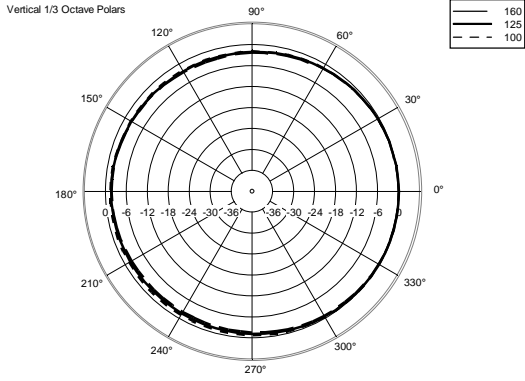

ACCESSORIES

AC WM-C WALL MOUNT FOR NEW COMPACT

PART NUMBER **13360199**
EAN: 8024530007355

HORIZONTAL BRACKET H-BR 2X COMPACT M 10

PART NUMBER **13360444**
EAN: 8024530018276

PANEL PNL IN-OUT SPEAKON

PART NUMBER **12399062**
EAN:

VERTICAL BRACKET V-BR 2X COMPACT M 10

PART NUMBER **13360447**
EAN: 8024530018306