

NXW 44-A

ACTIVE TWO-WAY COLUMN SPEAKER

DESCRIPTION

NXW 44-A is a column speaker masterfully engineered from the ground up to deliver stellar audio performance for Bands, DJs, Clubs, and Rental Companies. The best-in-class combination of premium RCF transducers and a 2,100W two-channel amplifier produce coherent 100° x 50° coverage for the listening area up to 135 dB SPL. The two-way design features three 10" neodymium woofers and a 3" driver on a constant directivity horn. The horn's design delivers accurate sound to the coverage area without tilting the enclosure. The speaker delivers an extended frequency range down to 45 Hz and can be used as a stand-alone speaker and flown. Pairing the speaker with subwoofers delivers full-range power for medium-sized concerts and DJ systems. Blending RCF proprietary FIRPHASE and Bass Motion Control DSP processing, the NXW 44-A speaker is perfectly tuned for absolute sound clarity and deep, powerful bass response. The rugged, tour-ready, high-quality baltic birch plywood cabinet is easy to carry and installed securely using the dedicated rigging points.



FEATURES

- Up to 135 dB Sound Pressure Level
- 2100W Class-D Amplifier
- 100° x 50° Constant Directivity Coverage Angle
- 3" Titanium Neodymium Compression Driver
- 3 x 10" High Power Neodymium Woofers
- 45-20000 Hz linear Frequency Response
- Bass Motion Control and FIRPHASE processing
- 8 x M8 Rigging Points and 8 x Quick Lock
- IP Rated Powercon TRUE1 TOP IN/OUT

TECHNICAL SPECIFICATIONS

Acoustical specifications	Frequency Response:	45 Hz ÷ 20000 Hz
	Max SPL @ 1m:	135 dB
	Horizontal coverage angle:	100°
	Vertical coverage angle:	50°
Transducers	Compression Driver:	1 x 1.4" neo, 3.0" v.c
	Woofers:	3 x 10" neo, 2.5" v.c
Input/Output section	Input signal:	bal/unbal
	Input connectors:	Combo XLR/Jack
	Output connectors:	XLR
	Input sensitivity:	-2 dBu/+4 dBu
Processor section	Crossover Frequencies:	800
	Protections:	Thermal, Excurs., RMS
	Limiter:	Soft Limiter
	Controls:	Linear, Boost, High-Pass presets, Volume
Power section	Total Power:	2100 W Peak
	High frequencies:	700 W Peak
	Low frequencies:	1400 W Peak
	Cooling:	Convection
	Connections:	Powercon TRUE1 TOP IN/OUT
Standard compliance	Safety agency:	CE compliant
Physical specifications	Cabinet/Case Material:	Baltic birch plywood
	Hardware:	8 x M8, 8 x quick lock
	Handles:	2 side
	Pole mount/Cap:	Yes
	Grille:	Steel
	Color:	Black
Size	Height:	1080 mm / 42.52 inches
	Width:	297.5 mm / 11.71 inches
	Depth:	373 mm / 14.69 inches
	Weight:	31.55 kg / 69.56 lbs
Shipping information	Package Height:	400 mm / 15.75 inches
	Package Width:	1115 mm / 43.9 inches
	Package Depth:	327 mm / 12.87 inches
	Package Weight:	33.65 kg / 74.19 lbs



PART NUMBER

- **13000806**
NXW 44-A
100-120V

- **13000805**
NXW 44-A
220-240V

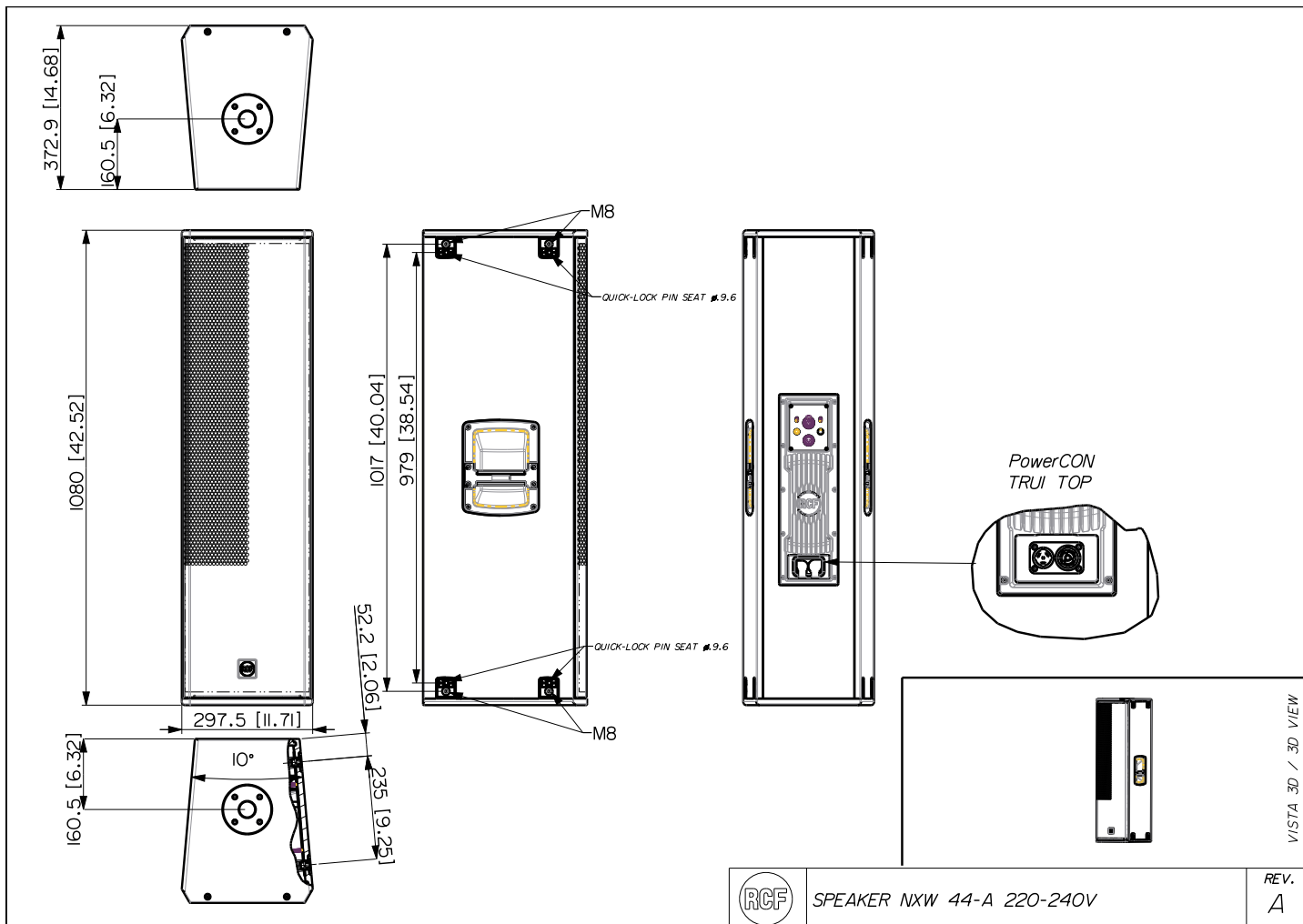

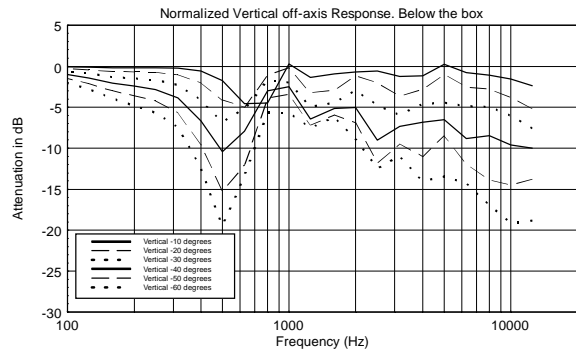
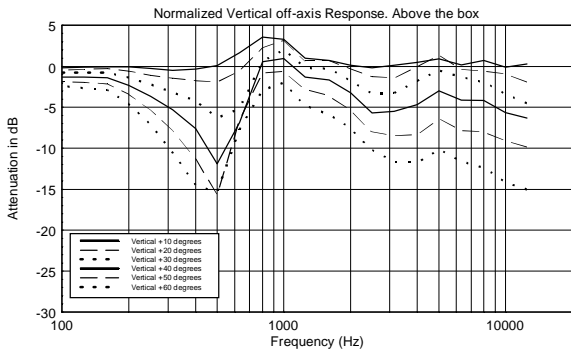
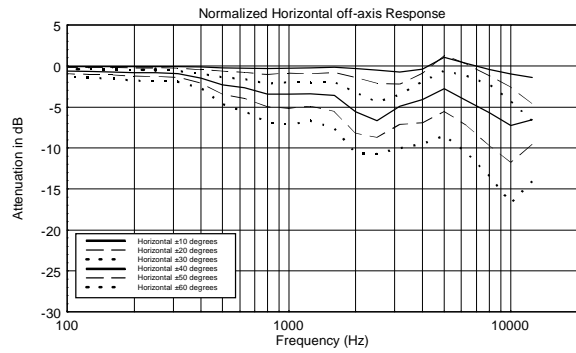
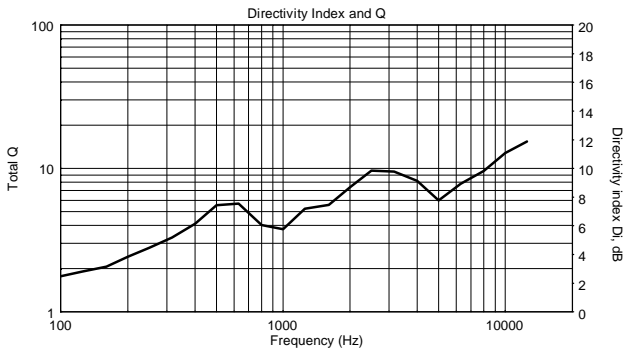
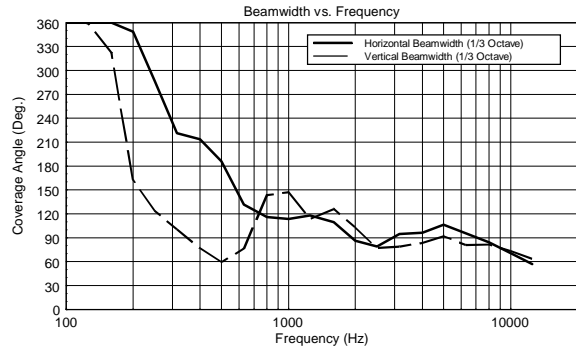
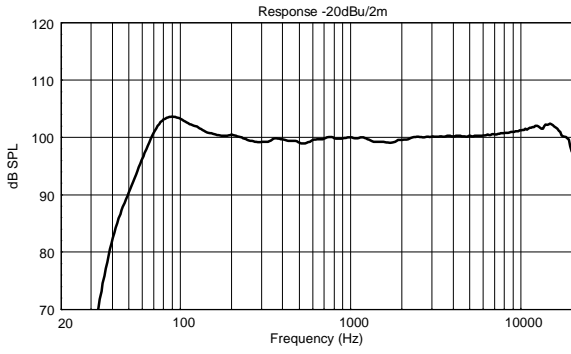

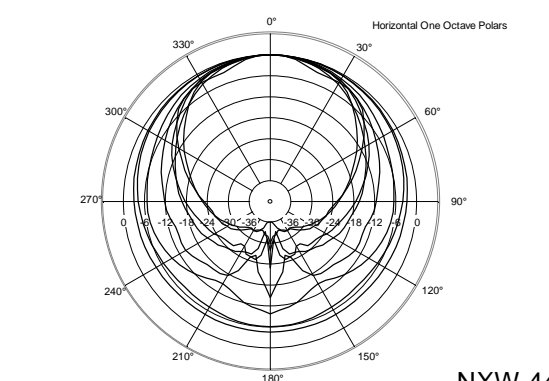
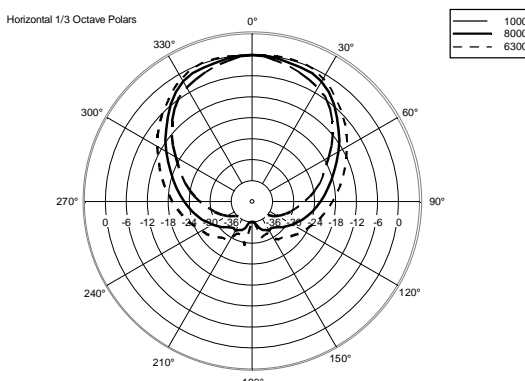
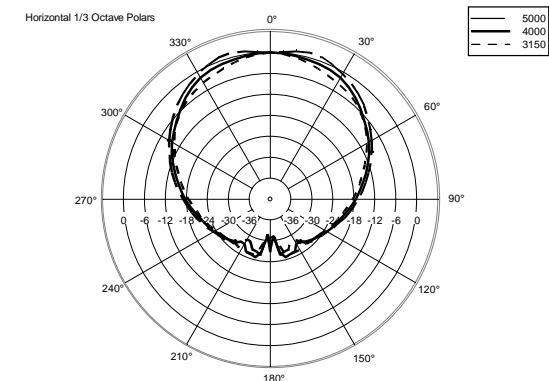
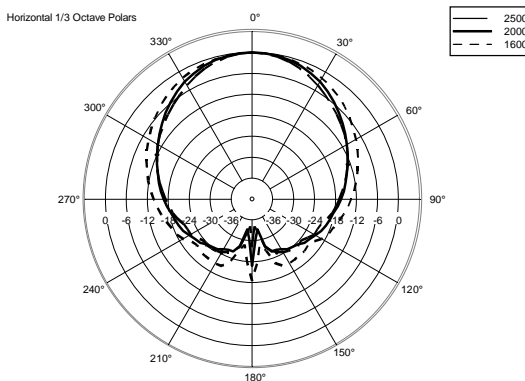
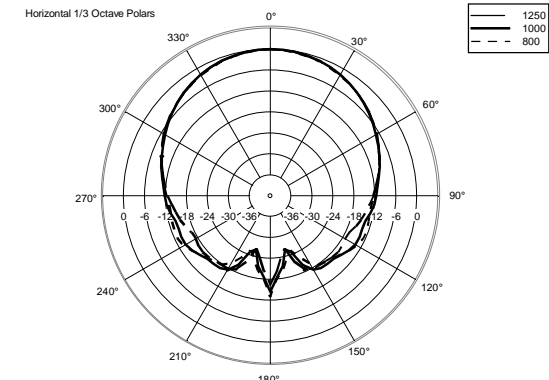
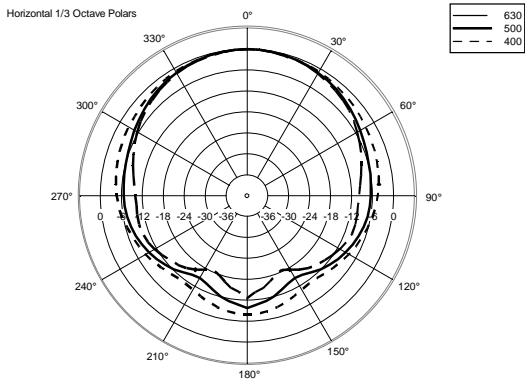
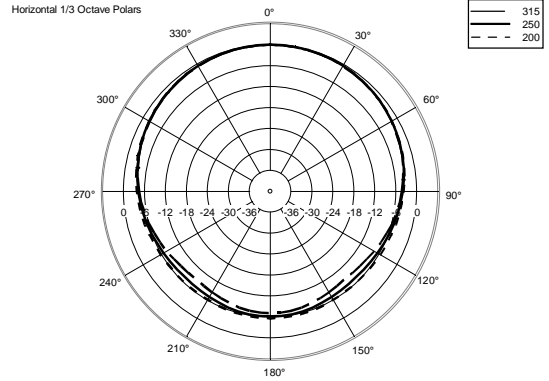
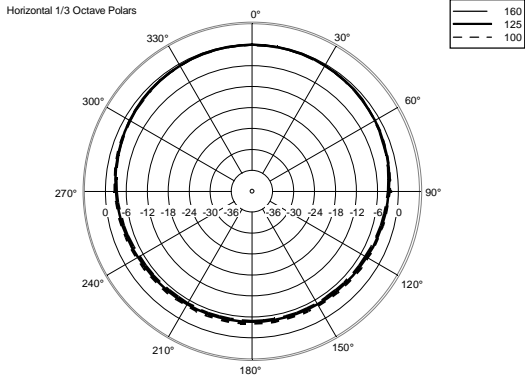

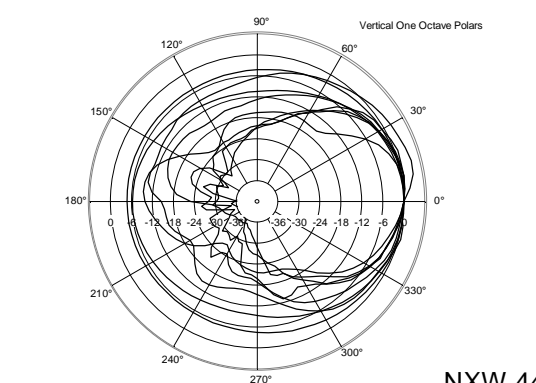
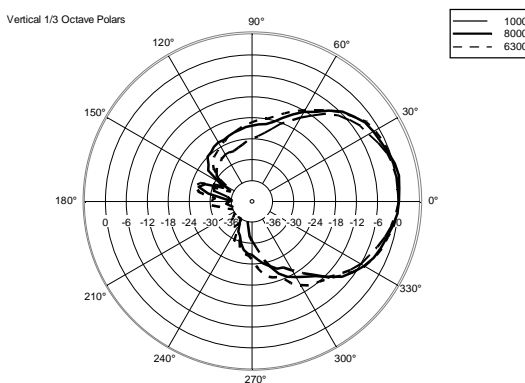
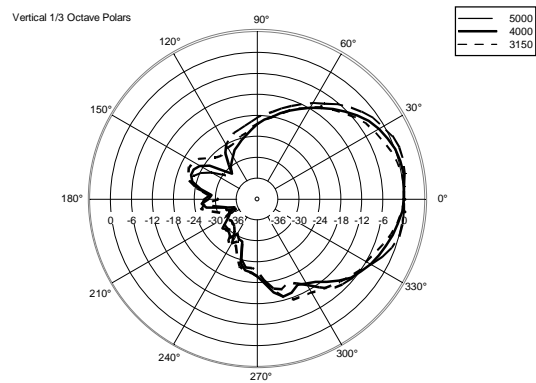
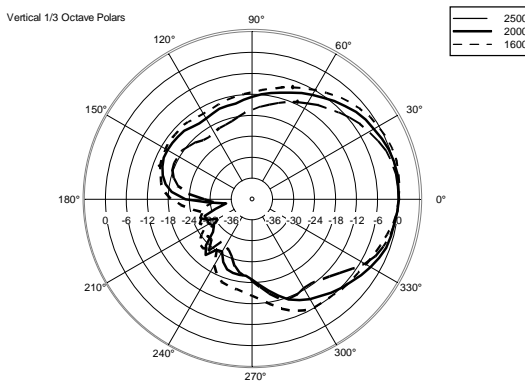
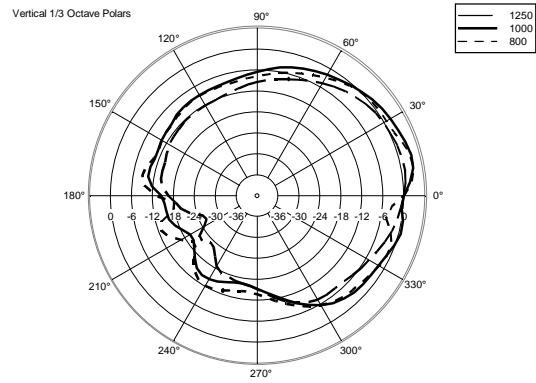
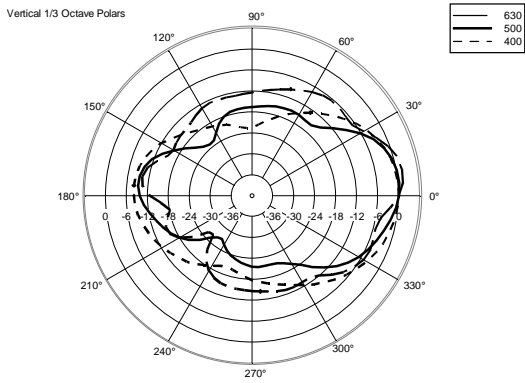
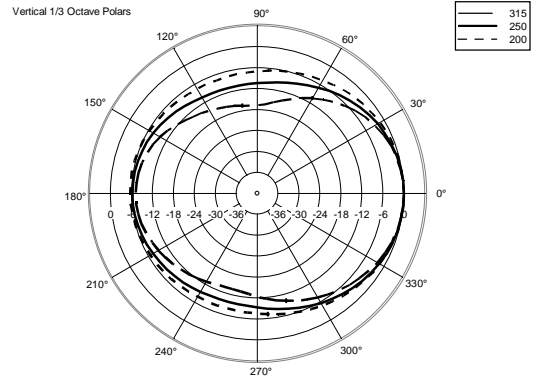
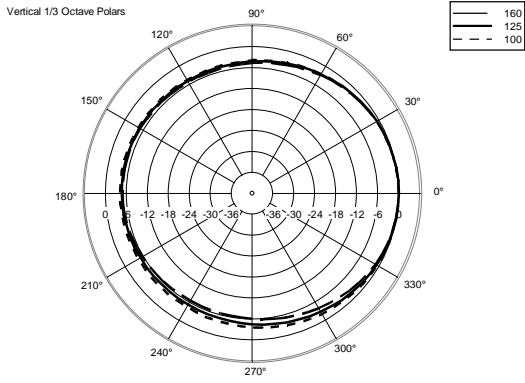

ACCESSORIES

AC PM-M20

PART NUMBER **13360067**
EAN: 8024530014599

AC PMX POLE MOUNT M20

PART NUMBER **13360232**
EAN: 8024530010058

AC PRO-FS PROFESS. LOCKING FLOOR STAND

PART NUMBER **13360109**
EAN: 8024530006471

AC PRO-PM PROFESS. LOCKING POLE MOUNT

PART NUMBER **13360110**
EAN: 8024530006488

FLY BAR FL-B NXL 44

PART NUMBER **13360345**
EAN: 8024530013653

RAIN PROTECTION RP 001

PART NUMBER **13360515**
EAN: 8024530020460

STACKING KIT 2X NXL44-A

PART NUMBER **13360347**
EAN: 8024530013646