



# TH+ HIGH DEFINITION

TOURING AND THEATRE

sound culture

**RCF**

ENG 2015



# TT+ HIGH DEFINITION TOURING AND THEATRE

---

RCF TT+ represents another prominent chapter in the long history of RCF sound systems. What ever a speaker system is designed for live sound, large concert situations or permanent installed theatre, today customers and audience expect a level of audio fidelity and intelligibility of such a standard unsurpassed by previous generations.

These requirement have fostered the need for audio professionals to be able to offer a range of speaker systems combined with dedicated processing and amplification technologies that are superior in acoustic performance and control technology.

TT+ series from RCF offers ready to use solutions and tools in true active high definition speaker systems.

The TT+ line consists of different true active and passive models, conceived and designed for specific applications.

From large venue systems to compact indoor sound reinforcement all the TT+ products offer:

- extremely compact dimensions;
- maximum output efficiency in sound pressure levels;
- minimum mechanical weight ratio;
- high power RCF precision Neodymium Transducers;
- high technology switching power supplies with Class D amplifiers;
- high quality analogue audio inputs and, for Line array systems, state of the art floating point DSP technology;
- baltic birch plywood cabinets and high quality mechanics.

---

## LINE ARRAY SYSTEMS

- **TTL55-A** pag. 8
- **TTL33-A II** pag. 12
- **TTL31-A II** pag. 14
- **TTL11A** pag. 16
- **TTP5-A** pag. 18

---

## NEAR FIELD SYSTEMS

- **TT5-A** pag. 20
- **TT2-A** pag. 22
- **TT1-A** pag. 24
- **TT25-A II** pag. 26
- **TT22-A II** pag. 27
- **TT08-A** pag. 29
- **TT052-A** pag. 30
- **TT051-A** pag. 31

---

## STAGE MONITORS

- **TT45-SMA** pag. 32
- **TT25-SMA** pag. 33
- **TT25-CXA** pag. 28

---

## SUBWOOFERS

- **TTS56-A** pag. 34
- **TTL36-AS** pag. 10
- **TTS36-A** pag. 36
- **TTS26-A** pag. 37
- **TTL12-AS** pag. 15



## **TT+** system solutions

With more than 50 years of experience RCF is one of the leading manufacturers of professional audio and one of the few companies to use its own transducers technology. RCF has pioneered many of the innovations now recognised and used in pro audio products.

Our products are designed in very close co-operation with our customers, offering complete solutions to meet the highest demanding market needs. The entire production process in RCF's Italian factory guarantees that RCF professional products comply with the highest quality standards.

The world wide RCF distribution network offers our customers the most complete and qualified support.

### ■ Touring

The capability of delivering superior SPL output of our systems will reduce the truck space requirements. The higher efficiency of integrated digital amplifiers will reduce the energy requirements and the integrated processing and the cabling reduction will make the set-up faster and easier.

### ■ Stadia and Arenas

Whether the event is a live performance or a sport match, whether the speaker system is a rented solution or a dedicated permanent installation, TT+ will excel for superior vocal intelligibility, dynamic of sound and musical clarity.



### ACTIVE AND CONTROLLED

TT+ systems are active and feature highly advanced digital or analogue electronic processing.

TT+ high power digital amplifiers offer very low distortion and natural sound with very efficient heat dissipation coupled with low energy consumption.

The integration of precise analogue and digital processing, directly available with simple presets, the possibility of monitoring and controlling the systems with RDnet proprietary protocol brings TT products to unmatched results in the audio industry.



### LARGE VENUES SYSTEMS

RCF TT+ large venues systems are a specifically designed group of products dedicated to highly demanding large scale applications. This system is designed to be easily scalable, from a few modules to full size arrays for very large outdoor stadia or public spaces.

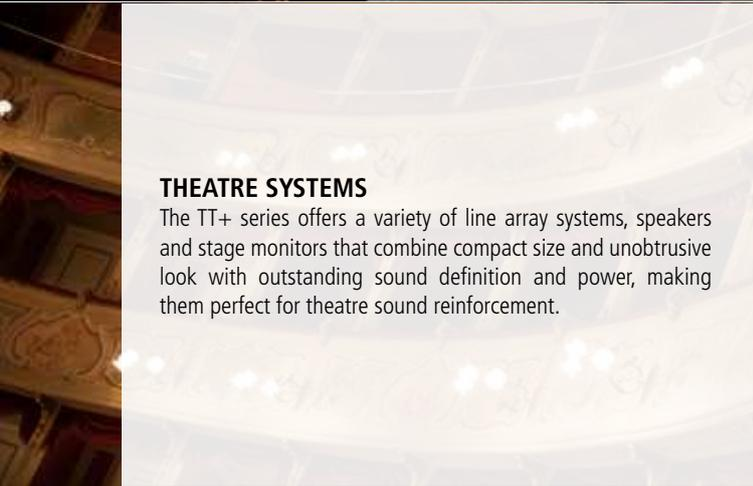

### THEATRE SYSTEMS

The TT+ series offers a variety of line array systems, speakers and stage monitors that combine compact size and unobtrusive look with outstanding sound definition and power, making them perfect for theatre sound reinforcement.

#### ■ Concert Halls

The incredibly low distortion of RCF digital amplifiers, the accuracy and transparency of the reinforcement, the possibility of controlling and monitoring each single speaker make the TT+ the perfect indoor system that will satisfy the most demanding artists, from opera and musicals to symphony and rock.



#### ■ Houses of Worship

From small and medium houses of god to very large community churches a TT+ system will always deliver unique intelligibility, well defined pattern control, exceptional feedback stability during speech and will immediately be ready to play high definition music and soundtracks at the desired spl level.



## Innovation, Integration, Intensity

**INNOVATION** - Our research and engineering department can offer innovative projects with finite control of each detail, from the loudspeaker voice coil wire to the highly efficient extended dynamic amplifier topology. There are many different ingredients that go into creating quality products and systems. These include computer aided simulation software to assist the understanding of transducer behaviour and amplifier operation and the relationship of dynamics and transient response. RCF utilises over thirty state of the art software packages to identify magnetic circuits, voice coil dynamics, suspension linearity, horn dispersion simulation, crossover filters, amplifier thermal behaviour and more.

**INTEGRATION** - RCF is one of the few loudspeakers manufacturers worldwide who have the ability to completely design and manufacture transducers, speaker systems and amplification and control electronics. Our 60 plus years heritage in audio combined with our state of the art R&D and manufacturing processes, allow us to seamlessly integrate all the ingredients to design and build the TT+ High Definition Touring and Theatre systems.

**INTENSITY** - The design philosophy for the TT+ Series is based upon offering the sound engineer solutions and tools that are ready to use. Key factors are the ability to sustain very high power with highly efficient sound pressure levels. Intense sound levels are created with extremely high definition and extended dynamic range. Modern construction materials result in mechanical weight ratios that are light for practical flying and portability.



### ■ Waves

New horn designs for the entire line. Precision waveguides for the line arrays midrange and compression drivers. Solid aluminium structures for compact two-way systems.



### ■ Structures

Baltic birch plywood cabinets. High quality steel mechanical fittings. Aluminium die cast handles. Powder coated grilles. Heavy duty polyurea or epoxy paint finishes on cabinet structures.

## RCF Precision Transducers

For over six decades RCF professional woofers have represented the ultimate performance, the highest power handling and the most advanced technology.

Thanks to high energy magnetic designs, complex cooling systems and specifically developed new technologies, our neodymium transducers put themselves at the same, unsurpassed level.

Technology and craftsmanship: every professional compression driver and woofer is precision built in our factory in Reggio Emilia, Italy, using the most advanced moulding and assembly technologies and our experienced dedication and attention.

TT+ large venues products offer ready to use solutions and tools in true active high power, high definition touring systems.

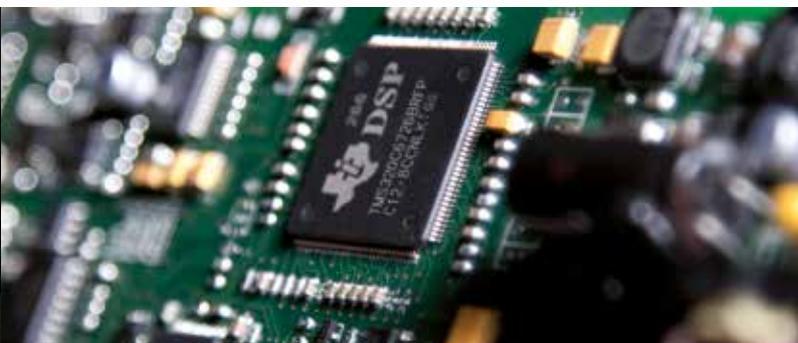

### ■ Power and control

Powerful switching power supplies. Low distortion and natural Class D amplifiers. Huge energy reserve in capacitor buses. Unique audio quality from an RCF exclusive premium analogue input board. Maximum flexibility and control from a newly designed 96 kHz, 32 bit floating point DSP.

### ■ Integrity

Advanced designs. High quality materials. Precise manufacturing. Precision assembly. Extensive quality control procedures. RCF's solid audio heritage.

# TTL55-A

## ACTIVE THREE-WAY LINE ARRAY MODULE

The TTL55-A is a high power, three way, active line array module engineered to deliver an incredible output for use in indoor and outdoor large spaces. The system is designed to be easily scalable from few modules for medium and small theatres to full size arrays for very large outdoor stadia and public spaces.

The three new designs for the six neodymium transducers that power the system represent the result of many years dedicated in pioneering new solutions using the best materials available on the market.

230V p/n 13000188  
115V p/n 13000189



ON BOARD

■ Touring



### THE BEST VOCAL CLARITY FROM A LARGE LINE ARRAY

The TTL55-A midrange transducer features a unique "Impedance Control Coil" technology. A secondary coil wound on the speaker yoke and driven in opposite phase to the primary coil has the function of cancelling the primary coil inductance, increasing the speaker sensitivity and reducing the speaker distortion. A primary effect of this technology is the improvement of the temporal behaviour of the speaker, improving the crossover transition from the midrange to the compression drivers.



#### COMPRESSION DRIVERS

- 3 x 1.5" throat neo compression drivers, 2.5" voice coil
- Very compact diameter design



#### WOOFERS

- 2 x 12" high power vented neo woofers, 4" voice coil
- Minimum weight basket design



#### MIDRANGE

- 10" Very high BL neo midrange, 3.5" voice coil
- Aluminium sealed basket design

The TTS56-A is the powerful choice for the large format TTL55-A line array systems. The TTS36-A is the preferred choice for more compact systems. For theatrical applications or as a bass complement for very large systems the TTL36-AS is the solution.

- Maximum output per size on the market
- 3500 W, 4 way digital amplification
- 2 x 12" high power neodymium woofers, 4" v. c.
- 10" neodymium midrange, 3.5" v. c.
- 3 x 1.5" neodymium compression drivers, 2.5" v. c.
- High quality analog input board
- 96 kHz, 32 bit DSP processing
- RDNNet ON BOARD
- Tour grade Baltic birch cabinet and mechanics



■ Live sound

■ Stadia and Arenas



The TTL55-A amplifier represents a state of the art execution of a Dsp controlled multi-way digital amplification. The analog input board offers xlr input and output link, cluster size control switches, high frequencies correction switches, pre-loaded equalizations by-pass switch.

■ INSIDE VIEW

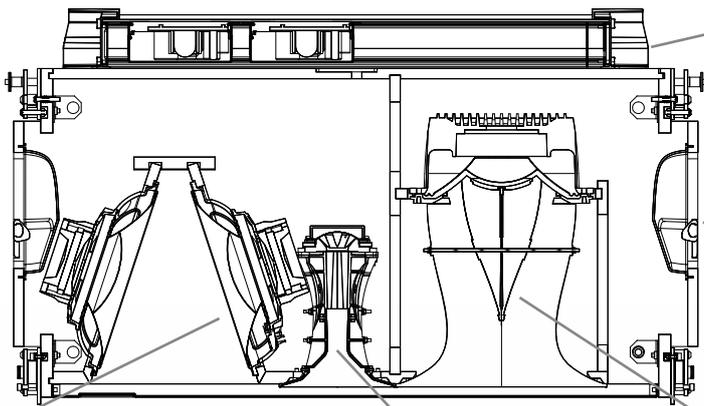

■ **POWER PLATFORM**  
The power section comprises 4 high power digital amplifiers, a state of the art 32 bit floating point Dsp processing, network board, high quality analog inputs.

■ **TOURING GRADE CABINET**  
The cabinet is in Baltic birch and the mechanics are laser cut in high grade steel. The weight of the system is less than many similar size passive competitors.

■ **LF CLAM SHELL CONFIGURATION**  
The 2 woofers, in a band-pass loading configuration, provide a very tight and powerful bass response. The acoustical configuration is very efficient in the 100 Hz region and free from dual source cancellations.

■ **HF ARRAY**  
The high frequency section employs three high power 2,5" voice coil compression drivers housed on a very compact slotted horn. Precision assembled titanium domes to produce very high power and clarity

■ **HORN LOADED MF**  
The 10" midrange is a state of the art neodymium design. It features a sealed aluminium basket, incredibly high BL product, a secondary "distortion reduction" coil. The transducer is loaded on a 4-slot constant directivity horn that guarantees a uniform vertical coupling module to module.

The signal processor is a 32 bit floating point Dsp running at 96 kHz. The Dsp takes care of crossovers, equalisations, soft-limiters, rms limiters, large signals compression and customised presets for the 4 way amplification.



**TEC AWARD  
NOMINATION**



# TTL36-AS

## ACTIVE LINE ARRAY SUBWOOFER MODULE

The TTL36-AS is the ideal flyable bass complement for the TTL55-A array system. The clam-shell design guarantees the maximum output per size while the 2 x 4.5" voice coil vented 18" woofer design offers the minimum of power compression. The TTL36-AS is perfect to create flown systems for theatrical and indoor requirements. For very large outdoor systems is the perfect complement to reinforce the TTL55-A bass performance in combination to the ultra powerful TTS56-A subwoofers.

230V & 115 V p/n 13000271

- 4000 Watt (2 x 2000 W digital switching amplifiers)
- 2 x 18" high power neodymium woofer, 4.5" v. c.
- 96 Khz, 32 bit DSP processing
- RNet ON BOARD
- Time delay alignment
- Cardioid preset for stacking groups of 3
- Tour grade Baltic birch cabinet, integrated rigging.
- Maximum output per size

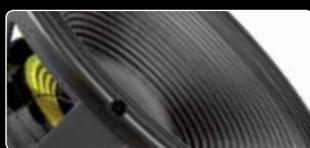

### WOOFERS

- 2 x 18" high power vented neo woofers, 4.5" voice coil
- Minimum weight design

The integrated mechanics provide perfect compatibility with the TTL55-A line array module. The TTL36-AS subwoofer can be rigged on top of the TTL55-A using the same fly-bar or on the side of the TTL55-A cluster on a separate fly-bar.

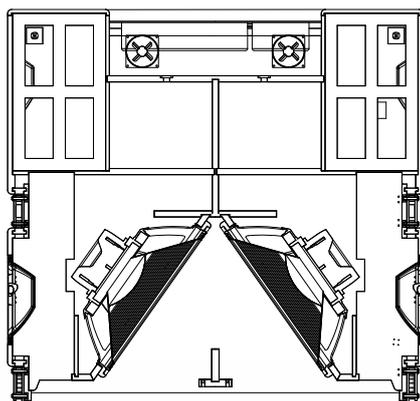

### VIRTUAL TILT AND CURVATURE

Taking advantage of the dsp power available on every cabinet it is possible, through RNet, to apply variable delays to single cabinets and create virtual tilting and curvature of TTL36-AS subwoofers clusters.

The cabinet features six newly designed die-cast aluminium side handles powder coated and with rubber hand-grip. Thanks to the internal scoop design it is possible to use the handle in three different directions to facilitate the transport, positioning and loading operations.



The TTL55-A and the TTL36-AS are equipped with a dedicated networking board. Using our proprietary RDNet protocol is possible to monitor all the system parameters, from the input to the status of each single amplifier.

Having a Dsp on board of each cabinet, it is possible to address to single cabinets or groups of cabinets specific presets or modifications of parameters like gain, equalisation or delay.

The RDNet protocol is based on RS-485 communication protocol, it is very stable and it is possible to send and receive data on a simple XLR cable.



The power section comprises 2 x 2000 watt digital amplifiers, a state of the art 32 bit floating point Dsp processing, time delay setting, network board, high quality analog inputs.



#### ■ SIDE HANDLE

The TTL55-A cabinet features a newly designed die-cast side handle with rubber hand-grip. Thanks to the internal scoop design it is possible to use the handle in three different directions.



#### ■ FRONT MECHANICS

All the mechanical structure is built in high strength structural steel. This special steel by a quenching and tempering process guarantees a yielding strength almost 4 times higher compared to commercial grade steel and maintains the mechanical properties down to  $-40^{\circ}\text{C}$ . Thanks to this material the mechanics have high safety factor with a weight under control.



#### ■ REAR MECHANICS AND ANGLES

The TTL55-A cabinet features 8 possible splay angles, from  $0^{\circ}$  to  $7^{\circ}$  with  $1^{\circ}$  step increment to create curved spiral arrays with very high precision.



#### ■ AMPLIFIER MECHANICAL STRUCTURE

The electronic processing and the amplifier are housed in a solid aluminium extrusion. The housing is tightly fitted to the rear of the cabinet and sealed. The power input and all the signal connectors are housed in two recessed and protected panels.



### THE TTL55-A CABINET

The TTL55-A cabinet is built in Baltic birch plywood and protected with heavy-duty coating. The internal structure is braced and reinforced and all the parts are assembled on metal inserts with metric screws. With a very small size compared to the spl output it is easily transportable as a single module on a dolly or in groups of four in dedicated karts. The front grille is powder coated a features and special foam backing very transparent to the sound.

# TTL33-A II

## ACTIVE THREE-WAY LINE ARRAY MODULE

The TTL33-A II offers the highest performance from a small size 3 way line array. The incredible high output and dynamics, the extreme accuracy and high frequency extension, plus compact size, make the TTL33-A II the ideal tool for reinforcing mid-large size outdoor and indoor live performance and events.

230V p/n 13000360  
115V p/n 13000361

- 750 W digital switching amplifiers
- Wide, constant directivity, coverage angle
- 2 x 8" high power neodymium woofers, 2.5" v. c.
- 8" neodymium midrange, 2.5" v. c.
- 3 x 1" neodymium compression drivers, 1.5" v. c.
- High quality analog input board
- 96 kHz, 32 bit DSP processing
- Soft limiter and RMS protection
- RNet ON BOARD
- Maximum output per size on the market

### ■ SUGGESTED SUBWOOFERS

- TTS56-A
- TTS36-A
- TTS26-A



ON BOARD



### RELIABLE MECHANICS

Laser cut high quality steel bars and precision machining for an easy to use and reliable mechanics. Thanks to the very light weight of the cabinet building the cluster is very simple, fast and effortless.

*The*  
**READERS'**  
**CHOICE**  
AWARDS 2013

**WINNER**



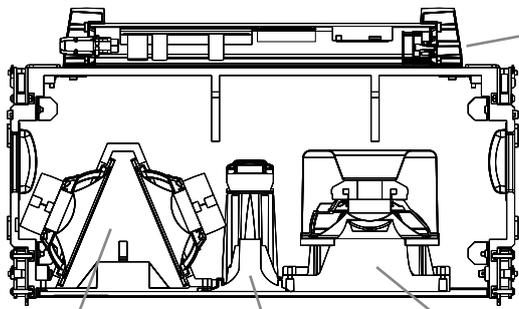

■ **POWER PLATFORM**

The TTL33-A II is powered by a 750 W switching power supply and 3 digital amplifiers: 500 W mid-bass, 500 W midrange and 250 W compression driver. The result is very high output, extremely low distortion and natural sound.

■ **TOURING GRADE CABINET**

The cabinet is in high quality Baltic birch plywood and the mechanics are laser cut in high grade steel. The weight of the system is less than many similar size passive competitors.

■ **CONTROLLED MID-BASS**

Light and reliable neodymium 8", in a band pass loading configuration, provides a tight and loud mid-bass. Thanks to a careful acoustic design the sensitivity in the 100 Hz region is almost double than typical, same size, designs.

■ **COMPRESSION DRIVERS**

A new compression driver has been developed for array applications. The best ratio between the size of the diaphragm and the overall diameter and the very small total size makes the ND1411-MT a unique driver for application in line on straight horns.

■ **HIGH OUTPUT MIDRANGE**

A fast and accurate horn loaded 8" takes care of the midrange frequencies in TTL33-A II. Powerful neodymium magnet, aluminium die cast basket, aluminium back can in direct contact to the rear plate for best heat dissipation.



■ **RD NET INPUT BOARD**

The TTL33-A II is equipped with a dedicated networking board. Using our proprietary RDNet protocol is possible to monitor all the system parameters, form the input to the status of each single amplifier.

Advanced technologies, knowledge, experience, continuous engineering effort and dedication were able to bring us to these unique results: the TTL33-A II.

Active, ultra compact, wide dispersion, line array module that set a new standard in touring and theatre sound reinforcement.



■ **DIGITAL PROCESSING**

The integrated digital processor is based on a state of the art 32 bit, floating point DSP running at 96 kHz sampling rate. The calculation capacity largely exceed the processing needs and the DSP is never pushed to the limit. Crossover and equalisation of the transducers, limiter, system presets: high pass, air absorption and cluster size corrections.



# TTL31-A II

## ACTIVE TWO-WAY LINE ARRAY MODULE

The TTL31-A II is a ultra-compact size 2 way line array. The very high output and dynamics, the extreme accuracy and high frequency extension, plus the very compact size make the TTL31-A II the ideal tool for indoor and theatre applications, live performances and events.

230V p/n 13000362  
115V p/n 13000363



ON BOARD



### PERFECT HF CONTROL

The 3 neodymium compression drivers are mounted on an unique straight horn, designed to offer the maximum control over the high frequencies. The unique compression driver design offers the minimum spacing between throats to avoid HF cancellation.

- 750 W digital switching amplifiers
- Wide, constant directivity coverage angle
- 8" high power neodymium woofer, 2.5" v. c.
- 3 x 1" neodymium compression drivers, 1.5" v. c.
- High quality analogue input board
- 96 kHz, 32 bit DSP processing
- Soft limiter and RMS protection
- RDNet ON BOARD
- Very high output per size



### RD NET INPUT BOARD

The TTL31-A II is equipped with a dedicated networking board. Using our proprietary RDNet protocol is possible to monitor all the system parameters, from the input to the status of each single amplifier.

### TTL31-A II CUT VIEW

The amplifier section features 750 W switching power supply module, 500 W for the LF, 250 W for the HF. It is equipped with extra capacitor bus able to sustain the voltage for 100 ms burst signals. The total power can be distributed to the 2 final amplifier sections. Each section has a very high maximum output power capability in order to provide, when necessary, maximum output burst in a specific frequency range.

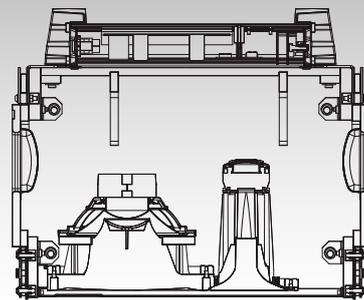

# TTL12-AS

## ACTIVE LINE ARRAY SUBWOOFER MODULE

The TTL12-AS is the ideal complement for the TTL31-A II array module. The band-pass design guarantees the maximum output per size while the 4" voice coil vented woofer design offers the minimum of power compression.

230V p/n 13000124  
115V p/n 13000151



### MECHANICS

The integrated mechanics provide perfect compatibility with the TTL31-A II line array module. The mechanical suspension system is in high quality steel, very precise and easy to use.

- 1000 W digital switching amplifier
- Band-pass design
- 12" high power neodymium woofer, 4" v. c.
- High quality analog input board
- Phase, crossover, bass shape controls
- Integrated mechanics
- Baltic birch cabinet
- Very high output

### ■ CONTROLLED BASS

The high power 12" neodymium woofer with a 4" voice coil guarantees a very controlled and precise bass response perfect for indoor applications such as theatres. A fully optimised T-pole design generates the minimum amount of flux modulation, the unique dual-forced air venting system guarantees a very efficient voice coil ventilation for minimum power compression and higher power handling.

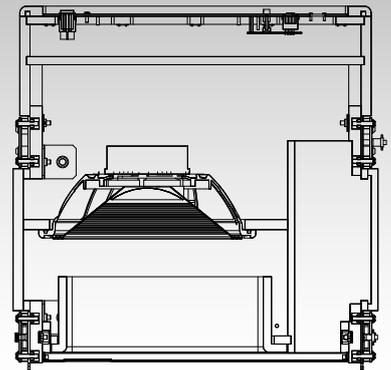

### ■ DESIGNED FOR TTL31-A II

The TTL12-AS subwoofer array module has been specifically designed to be coupled to the TTL31-A II.



# TTL11A

## ACTIVE DIGITALLY STEERABLE ARRAY

The TTL11A is an active column speaker array system composed of two modules, one for the mid-high and one for the bass frequencies. The TTL11A-H is the HF module and is equipped with four 2.5" neodymium compression drivers with 1.5" exit throat. The TTL11A-B is the bass frequency section of the system and features four 8" neodymium woofers with 2.5" voice coil for a perfect and powerful mid-bass response. With the addition of the new TTS26-A subwoofer, the TTL11A system becomes a powerful, compact and high definition live sound system.

**TTL11A-H** 230V p/n 13000237  
115V p/n 13000238

**TTL11A-B** 230V p/n 13000239  
115V p/n 13000240

- Tour grade cabinet and mechanics
- 4000 Watt, 9 way amplification
- 4 x 1.4" titanium dome neo c. drivers, 2.5" v.c.
- 3 x 8" neo midranges, 2.5" v.c.
- 4 x 8" neo woofers, 2.5" v.c.
- 96 Khz, 32 bit DSP processing
- Digital steering down to -10°
- Maximum output per size
- RDNet READY



### DIGITAL STEERING PROCESSING

The TTL11A includes a full tilting and beaming control offering five possible installation height set-up and three different throw choices.

The input board includes a generic wide dispersion set-up.



### FAST LOCKING MECHANICS

The TTL11A cabinet features integrated quick lock mechanics to provide a perfect stability during live events or easy assembling for permanent installation.

## TTL11A-H

### DIGITAL STEERABLE ARRAY MID HIGH

- 2000 Watt, 7 way amplification
- 96 Khz, 32 bit DSP processing
- 5 steps tilting control
- Beam forming, time delay controls
- Processed output to TTL11A-B
- Full range, high pass configurations
- Powercon input/output



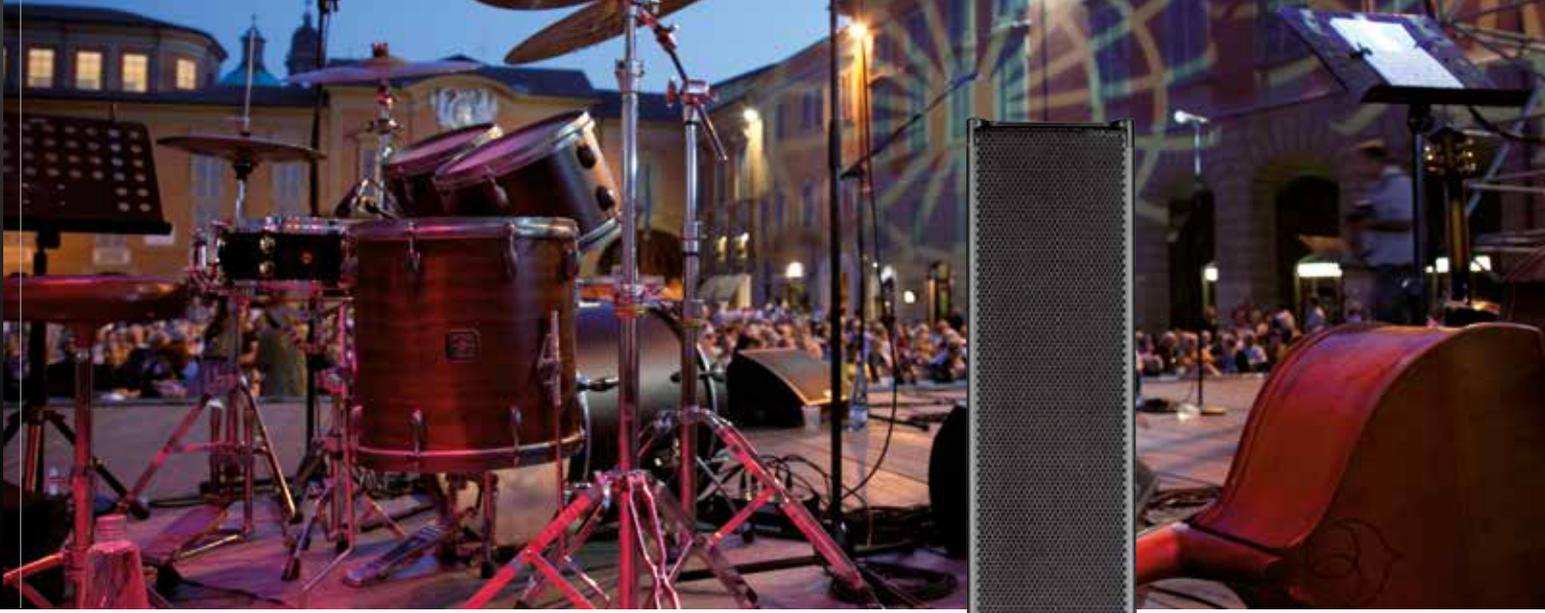

#### HF HORN

The compact multi-way constant directivity horn is equipped with four 2.5" titanium compression drivers and delivers an incredible output with a perfect pattern control.



The TTL11A and TTS26-A systems are equipped with a dedicated networking board. Using our proprietary RDNet protocol it is possible to monitor all the system parameters, form the input to the status of each single amplifier. Having a Dsp on board of each cabinet, it is possible to address to single cabinets or groups of cabinets specific presets or modifications of parameters like gain, equalisation or delay.



### TTL11A-B

DIGITAL STEERABLE ARRAY  
BASS

- 2000 Watt, 2 way amplification
- High quality analog input board
- 4 x high power neodymium transducers
- Processed input from TTL11A-H
- Powercon input/output

- TTL11A-H and TTL11A-B are equipped with heavy duty multi-functional top and bottom mechanics

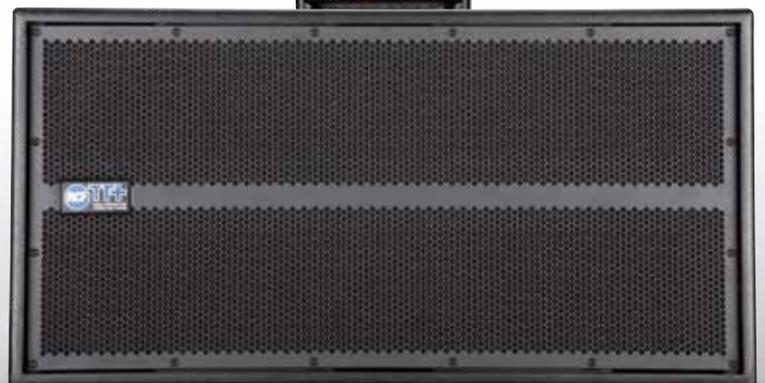

#### ■ PERFECT COMBINATION

The TTS26-A is the perfect complement for the TTL11A column array system, increasing the system performance.

#### ■ MODULAR SYSTEM

The TTL11A and TTS26-A together form a very flexible modular system depending from the size of the event to amplify. High quality mechanics with a unique smart locking system make the set up of the system fast and effortless.

# TTP5-A

## POINT SOURCE ARRAY

The TTP5-A is a high power, two way, active array module engineered to deliver high fidelity output for use in indoor and outdoor medium and large spaces. The system is designed to create horizontal or vertical arrays with a constant curvature. The RCF Precision newly designed 4" compression driver loaded on a dedicated waveguide guarantees the exceptional sound projection and pattern control. The new woofer design represents the result of many dedicated years in developing new solutions using the best materials available on the market. The integration of two channels 1600 Watt digital amplification and the advanced digital processing set a new standard for distortion, noise and thermal efficiency.

230V p/n 13000380  
115V p/n 13000384

- 1600 Watt, 2 way amplification
- 15" neo woofer, 4.0" v.c.
- 2.0" titanium dome neo c. driver, 4.0" v.c.
- 22.5° x 60° precision waveguide
- 96 Khz, 32 bit DSP processing
- Maximum output, perfect audio fidelity
- Tour grade cabinet and mechanics
- RNet ON BOARD



ON BOARD

■ Auditoriums

■ Theatres

■ Live Sound



### MULTIFUNCTIONAL HANDLES

The TTP5-A features comfortable side and top handles in rubber coated aluminium to provide an easy transport and positioning.

### MODULAR SYSTEM

The TTP5-A is a flexible modular system, easily array-able depending on the size of the event and the required coverage. High quality mechanics with a smart locking system make the set up of the system fast and effortless.



### ■ 4.0" TITANIUM DOME NEO C. DRIVER

Technology and craftsmanship: every professional compression driver and woofer is precision built in our factory in Reggio Emilia, Italy, using the most advanced moulding and assembly technologies and our experienced dedication and accuracy.



### ■ 15" NEO WOOFER

The high power 15" neodymium woofer with a 4" voice coil guarantees a very controlled and precise bass response perfect for indoor applications such as theatres. A fully optimised T-pole design generates the minimum amount of flux modulation, the unique dual-forced air venting system guarantees a very efficient voice coil ventilation for minimum power compression and higher power handling.



### ■ FULLY FEATURED INPUT BOARD

TT5-A, TT2-A AND TT1-A are equipped with a state of the art input board which features:

- XLR In/Out
- Gain reduction
- Time Delay
- Speaker presets
- RNet ready option
- RNet bypass switch
- 4 status LEDs
- Powercon In/Out

TTP5-A has in addition the RNet IN-OUT panel On Board.



TTP5-A is equipped with Powercon connectors.



■ Stadia

■ Arenas

■ Club Systems



**TOUR GRADE CABINET**

The TTP5-A cabinet is made of marine baltic birch plywood coated with heavy duty polyurea finish. The structure is heavily braced and all the fittings are designed to fulfil the requirements of a long touring life.

**QUICK LOCKING**

The TTP5-A features integrates mechanics with quick locking pins. The pin insertion can be both frontal or lateral for easy assembling of both horizontal or vertical arrays.



■ ACTIVE SYSTEMS

The new TT+ Two-Way Systems are equipped with class D power amplifiers controlled from 32 bit floating point DSPs running at 96 kHz. All the amplifiers are housed in a separate chamber and floating to be insulated from vibrations.



The TT+ new systems are ready to be equipped with a dedicated networking board. Thanks to our proprietary RDNET protocol is possible to monitor all the system parameters, from the input to the status of each single amplifier. Having a Dsp on board on each cabinet, is possible to address to single cabinets or groups of cabinets specific presets or modifications of parameters like gain, equalisation or delay. The RDNET protocol is based on RS-485 communication protocol, it is very stable and it is possible to send and receive data on a simple XLR cable.

# TT5-A

## ACTIVE HIGH OUTPUT TWO-WAY SPEAKER

Thanks to the powerful 4" compression driver, the large sized horn, the incredibly fast woofer, TT5-A offers the highest performance from a wide dispersion, active, 2 way system. High output and dynamics, extreme linearity and fidelity makes the TT5-A a unique product in its category. The TT5-A is the ideal professional two-way speaker for mid field and near field sound reinforcement, live performance and events. The RCF Precision newly designed 4" compression driver guarantees the exceptional sound projection and pattern control. The integration of the 1600 Watt, digital amplification and the advanced digital processing set a new standard for distortion, noise and thermal efficiency. The speaker is equipped with a complete set of integrated rigging mechanics for rental or installation.

- 1600 Watt, 2 way amplification
- 15" neo woofer, 4.0" v.c.
- 2.0" titanium dome neo c. driver, 4.0" v.c.
- 90° x 50° precision waveguide
- 96 Khz, 32 bit DSP processing
- Maximum output, perfect audio fidelity
- Tour grade cabinet and mechanics
- RNet READY

230V p/n 13000379  
115V p/n 13000383



### ■ A/V Presentations

### ■ Houses of Worship



Pushing the rear encoder it is possible to select the following three functions:

- input gain reduction
- speaker delay setting
- selection of a speaker preset

**MAXIMUM FLEXIBILITY**  
The TT5-A is the perfect tool for theatrical installations, front and side fills, and distributed sound systems.

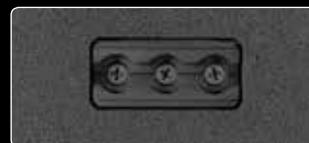

With the RNet protocol it is possible to monitor all the system parameters, from the input status of each single amplifier.

Thanks to the integrated DSP board on each unit, it is possible to address the single cabinets or groups of cabinets' specific presets via the RNet GUI software as well as to modify parameters like gain, equalisation and delay.



TT5-A is the result of an incredibly advanced acoustic design, state of the art digital power amplifiers and a group of innovative processing algorithms that, running at 96 KHz, take care of the speaker linearity and its dynamic control.

### ■ UNLIMITED POWER

TT5-A features a newly designed class D amplifier delivering 1100 Watt for low frequencies and 500 Watt for high frequencies.





**POLE MOUNT**

A rugged powder coated steel pole mount has been installed on bottom of the TT5-A to provide a pole mount option.

The rear panel features a simple rotary encoder to control all the speaker functions. A bright 7 segment display clearly help the system setting. The only switch on the panel set the local or remote control. A simple command from RDNet totally disable the input panel.



The design philosophy for the new TT+ series is based upon offering the sound engineer solutions and tools that are ready to use. Key factors are the ability to sustain very high power with highly efficient sound pressure levels. Intense sound levels are created with extremely high definition and extended dynamic range. Modern construction materials result in mechanical weight ratios that are light for practical flying and portability.

The TT5-A is a high power, active loudspeaker designed specifically for high quality indoor and outdoor near and mid field sound amplification.

It is equipped with 1600 W digital amplification, 1100 W are delivered from the low frequencies amplifier and 500 W from the high frequency digital module.

The low frequencies transducer is a powerful 15" hyperventated woofer with 4" voice coil.

A large sized 2" titanium dome compression driver loaded to a 90°x 50° dispersion constant directivity horn provides a perfect high frequencies coverage.

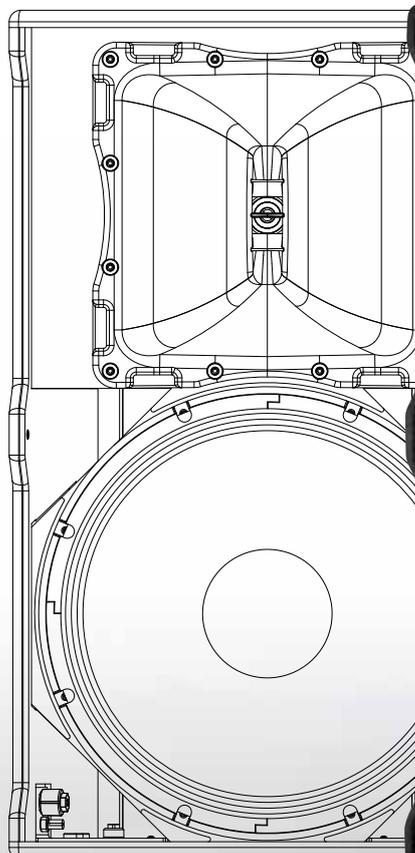

# TT2-A

## ACTIVE HIGH OUTPUT TWO-WAY SPEAKER

The TT2-A is the most flexible and powerful tool in its class. The incredible output and dynamics, the extreme linearity and fidelity makes the TT2-A a special product in its category. The TT2-A is the ideal compact two-way speaker for near field sound reinforcement, live sound and corporate events. The integration of the 1600 Watt, two channel, digital amplification and the advanced digital processing set a new standard for distortion, noise and thermal efficiency. The speaker is equipped with a complete set of integrated rigging mechanics for rental or installation. Dedicated accessories to create clusters are available.

230V p/n 13000378  
115V p/n 13000382

- 1600 Watt, 2 way amplification
- 12" neo woofer, 4.0" v.c.
- 2" titanium dome neo c. driver, 3.0" v.c.
- 90° x 50° precision waveguide
- 96 Khz, 32 bit DSP processing
- Maximum output, perfect audio fidelity
- Tour grade cabinet and mechanics
- RNet READY



READY



### POLE MOUNT

A rugged powder coated steel pole mount has been installed on bottom of the TT2-A to provide a pole mount option.

The rear panel features a simple rotary encoder to control all the speaker functions. A bright 7 segment display clearly help the system setting. The only switch on the panel set the local or remote control. A simple command from RNet totally disable the input panel.



A 32 bit, floating point dsp, processing signal at 96 KHz is taking care of :

- 2 way system crossover and transducers alignments
- 8 programmable system equalisation
- Programmable output time delay
- Input Sensitivity reduction
- Soft limiter and gentle compressor for very high signal inputs
- Rms current monitoring and transducers protection
- Input noise reduction

A specially developed algorithm takes care of the frequency dependent soft limiter offering to the listener the same linearity of the system from very low level signals to the maximum amplifiers output .



The RCF wood-shop dept. are assured in their knowledge that the Baltic Birch plywood cabinets take care of every detail. Every layer is glued with special adhesive to make the cabinet completely water resistant even before the painting process is completed with a thick full coating of special polyurea paint. The internal structure is heavily braced to survive long term use and transportation and all parts are assembled on metal inserts with metric screws offering several rigging possibilities.



The cabinet features two newly designed die-cast aluminium side handles powder coated and with rubber hand-grip. Thanks to the internal scoop design it is possible to use the handle in three different directions to facilitate the transport, positioning and loading operations.

A dedicated processing area is available through the optional RDNet input board. Remote monitoring, special custom equalisations, high and low pass, single way solo and mute, and many other options. All available on RDNet.



Every model is equipped with a rear encoder making possible the selection of:

- input gain reduction
- speaker time delay
- selection of eight speaker presets dedicated to Close, Linear and Far listening

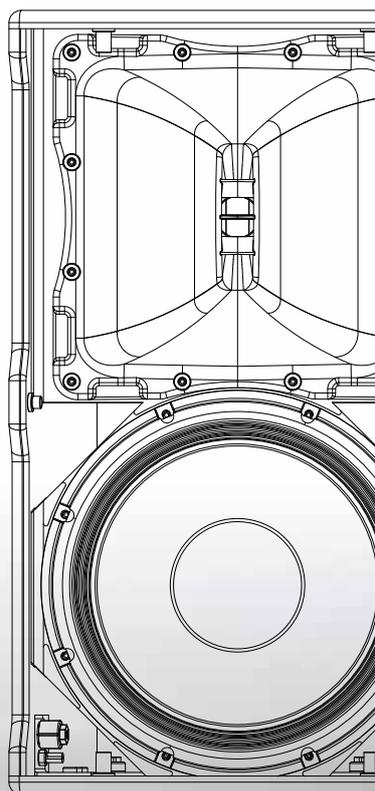

# TT1-A

## ACTIVE HIGH OUTPUT TWO-WAY SPEAKER

Hi-fi acoustic design, superb deep bass punch, very linear and precise frequency response. The TT1-A is the perfect small and powerful speaker for almost any sound reinforcement situation. Ideal for live sound situations, incredible for playback and monitoring. The TT1-A, unique in its category, features a neodymium 3.0" voice coil compression driver on a large, constant directivity, precision horn. The integration of the 800 Watt, two channels, digital amplification and the advanced digital processing set a new standard for distortion, noise and thermal efficiency. The speaker is equipped with a complete set of integrated rigging mechanics for rental or installation. Dedicated accessories to create clusters are available.

230V p/n 13000377  
115V p/n 13000381

- 800 Watt, 2 way amplification
- 10" neo woofer, 3.0" v.c.
- 2" titanium dome neo c. driver, 3.0" v.c.
- 90° x 60° precision waveguide
- 96 KHz, 32 bit DSP processing
- Maximum output, perfect audio fidelity
- Tour grade cabinet and mechanics
- RNet READY



The voice coil assembly is designed using a high strength, high temperature Kapton voice coil former, rectangular profile copper clad aluminium wire and assembled using advanced, specially formulated adhesives. Proprietary curing processes ensure optimal assembly strength and safe operation even under extreme thermal conditions. The top of the former is bent and bonded directly to the edge of the titanium diaphragm resulting in a Direct Drive™ configuration. Direct Drive™ guarantees optimal transfer of energy between the voice coil and the dome assembly providing smoother, extended frequency response beyond 10 kHz, reducing break up modes and lowering distortion. This assembly delivers high power handling along with excellent mechanical and thermal properties that make the compression driver exceedingly reliable and robust.

Decades of experience in the RCF laboratories has resulted in a revolutionary approach to sound design, enabling the company to exploit their know-how throughout the entire product chain in a way that very few companies in the world can do. RCF mastermind every single component and detail of the design and manufacture process, and the TT+ two-way systems are the result of an extremely advanced acoustic design, state-of-the-art transducers, digital power amplifiers and innovative processing algorithms.

TT+ two-way speakers are a byword in the touring business for sound quality, dynamic range and system features. Their cabinet construction, portability and installation solutions set new standards for professionals.



Two independent Class D digital amplifiers, characterised by high efficiency, hi-fi sound, extremely low distortion with negligible quiescent noise and stable burst response, make the TT+ speakers the most powerful two-way cabinets in their category. The amp modules are housed in a separate chamber and are mechanical insulated from the cabinet vibration. Specially developed algorithms, running at 96 kHz, enhance the linearity of the system from very low level signals to maximum amplifier output.

The design philosophy for the new TT+ series is based upon offering the sound engineer solutions and tools that are ready to use. Key factors are the ability to sustain very high power with highly efficient sound pressure levels. Intense sound levels are created with extremely high definition and extended dynamic range. Modern construction materials result in mechanical weight ratios that are light for practical flying and portability.





The speaker offer many rigging possibilities:

- Top M20 insert
- Pole Mount on the bottom
- Top an bottom fly tracks (6x)
- Side quick lock pins (4x)
- Side M10 rigging points (4x)

The paint department inside our factory in Italy utilizes a special polyurea paint to create a very thick full coating of the cabinet making it highly resistant to scratches and bumps.



For the TT+ series new state-of-the-art RCF transducers were specifically developed and new horn designs guarantee a uniform pattern coverage and perfect loading to the lowest frequencies. The compression drivers feature high performance 3-inch and 4-inch diaphragms; RCF has finalised an oxygen free process of moulding pure titanium ultra thin films in high quality finely controlled shaped diaphragms. The strong neodymium magnetic structure of the mid-bass transducers guarantees dynamism and precision, and the unique Dual-forced venting offers a very efficient voice coil ventilation, minimising the power compression.

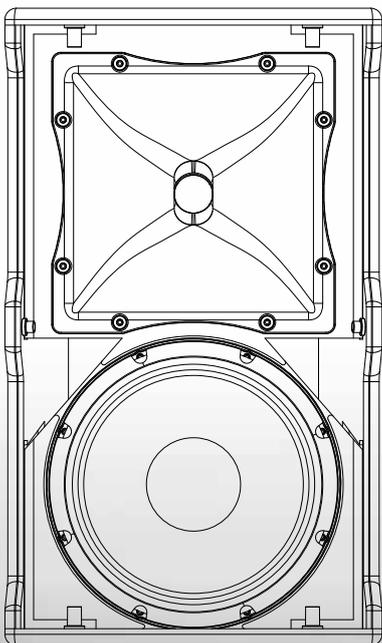

RCF is one of only a few loudspeaker manufacturers worldwide who have the ability to completely design and manufactures transducers, speaker systems and amplification and control electronics. Our 60 plus years heritage in Audio combined with our state of the art research and development and manufacturing processes allows us to seamlessly integrate all the ingredients to design and build TT+.



# TT25-A II

## ACTIVE HIGH DEFINITION TWO-WAY SPEAKER

The TT25-A II is the most flexible and powerful tool in its class. TT 25-A II offers very high output and dynamics, and extreme linearity and accuracy in a compact size.

TT25-A II is a 2-way active system featuring 15" neo woofer, 86 mm voice coil in a bass reflex configuration; 1,5" exit, 75 mm voice coil neo compression driver; 90° x 60° constant directivity horn, 90° rotatable.

The TT25-A II is the ideal professional speaker for sound reinforcement, live performances and events.

230V p/n 13000446  
115V p/n 13000447



ON BOARD



The rear panel features a simple rotary encoder to control all the speaker functions. A bright 7 segment display clearly help the system setting. The only switch on the panel set the local or remote control. A simple command from RDNet totally disable the input panel.

The cabinets features six fly-track rigging points



- 1100 W Class D Amplifier
- 90 x 60 constant directivity coverage angle
- 15" neo woofer, 3.5" mm voice coil
- 1.5" neo c. driver, 4.0" mm voice coil
- DSP Processing
- Onboard RDNet Control
- Multifunctional cabinet
- Very high output



Two independent Class D digital amplifiers, characterised by high efficiency, hi-fi sound, extremely low distortion with negligible quiescent noise and stable burst response, make the TT+ speakers the most powerful two-way cabinets in their category.

Specially developed algorithms, running at 96 kHz, enhance the linearity of the system from very low level signals to maximum amplifier output.

The speaker offer many rigging possibilities:

- Top an bottom fly tracks (6x)
- Top M20 insert
- Side quick lock pins (4x)
- Pole Mount on the bottom
- Side M10 rigging points (4x)



# TT22-A II

## ACTIVE HIGH DEFINITION TWO-WAY SPEAKER

TT22-A II is a 2-way active system featuring 12" neodymium woofer, 86 mm voice coil in a bass reflex configuration and a 1,4" exit, 75 mm voice coil neo compression driver. An extremely careful acoustic design plus the highest quality transducers and a powerful amplifier make the TT 22-A II speaker system the perfect solution from live sound situations to playback and monitoring. The amplifier section features 1100 watt power, 800 watt low frequency, 300 watt high frequency. The cabinet is made of marine baltic birch plywood and features high resistance polyurea coating. The cabinets features 2 side handles, 6 x fly-track rigging points, quick lock pin receptacles and a steel pole mount.

230V p/n 13000444  
115V p/n 13000445



ON BOARD



The TT22-A II new woofer features an extremely fast and accurate bass response and a natural and neutral mid-range response

The cabinet features Quick Lock pin receptacles



- 1100 W Class D Amplifier
- 90 x 60 constant directivity coverage angle
- 12" neo woofer, 3.5" mm voice coil
- 1.5" neo c. driver, 3.0" mm voice coil
- DSP Processing
- Onboard RDNet Control
- Multifunctional cabinet
- Very high output

The cabinet features two newly designed side handles with rubber hand-grip.



The design philosophy for the new TT+ series is based upon offering the sound engineer solutions and tools that are ready to use. Key factors are the ability to sustain very high power with highly efficient sound pressure levels. Intense sound levels are created with extremely high definition and extended dynamic range. Modern construction materials result in mechanical weight ratios that are light for practical flying and portability.



With the RDNet protocol it is possible to monitor all the system parameters, from the input status of each single amplifier.

Thanks to the integrated DSP board on each unit, it is possible to address the single cabinets or groups of cabinets' specific presets via the RDNet GUI software as well as to modify parameters like gain, equalisation and delay.

# TT25-CXA

## ACTIVE HIGH DEFINITION COAXIAL MONITOR

The TT25-CXA is a full range, high performance coaxial monitor. The linear curve response, the consistent coverage and acoustic output make the TT25-CXA II the professional choice for most demanding situations. The voicing is accurate and deep, the sound transparent in the mids and extremely accurate at very high frequencies. The size is compact and the profile very low for a discrete appearance. The TT25-CXA is a full range, high power active system that sets a new standard in the touring and theatre sound reinforcement. By producing flat amplitude and phase response, full-range bandwidth and exceptional impulse response, the TT25-CXA far exceeds the capabilities of conventional stage monitors.

230V p/n 13000448  
115V p/n 13000449



ON BOARD



The beam width remains consistent across the horn's operating frequency range and coverage (60° conical) allows the performer great freedom of movement within the coverage area.

The cabinet is made of marine Baltic birch plywood and features high resistance polyurea coating. The cabinets features one aluminium top handle and a side pole mount.



- 1100 W Class D Amplifier
- 60 x 60 constant directivity coverage angle
- 15" neo coaxial woofer, 3.5" mm voice coil
- 1.5" neo coaxial c. driver, 2.5" mm voice coil
- DSP Processing
- Onboard RDNet Control
- Multifunctional cabinet
- Very high output

The TT25-CXA II horn on a coaxial transducer exhibits constant Q.

Frequency response is uniform across the specified beam width, with minimal side lobes.

The compact, active, TT25-CXA enclosure houses a coaxial 15-inch neodymium cone driver and a 64mm diaphragm compression driver along with phase-corrected control electronics and amplification.

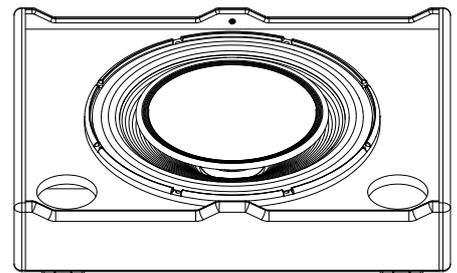

The amplifier section features 1100 watt switching power supply module, 800 watt low frequency, 300 watt high frequency. The input section provides In/Out XLR connectors, central encoder to control system parameters, RDNet Input and Output. The AC panel features Input and Output powerCON Connectors.



# TT08-A

## ACTIVE TWO-WAY PRECISION MONITOR

The TT08-A is the smallest and powerful solution to almost any sound reinforcement situation.

Hi-fi acoustic design, high quality neodymium transducers, powerful amplifiers, very compact size cabinet and incredibly lightweight.

Superb deep bass punch, very linear and precise frequency response. The perfect solution for live sound situations, playback and monitoring.

230V p/n 13000116  
115V p/n 13000120



### OUTSTANDING POWER

Though remarkably compact and lightweight, the TT08-A offers an incredible maximum SPL of 128 dB, making it suitable for use as either a single, primary loudspeaker or within multi-cabinet horizontal and vertical arrays.

### MAXIMUM FLEXIBILITY

The TT08-A is the perfect tool for broadcast monitoring, theatrical installations, front and side fills, under balcony coverage and distributed sound systems.

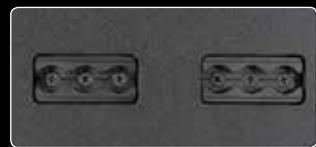

- 750 W power digital switching amplifiers (500 on the woofer, 250 on the compression driver)
- 90° x 60° constant directivity coverage angle
- 8" high power neodymium woofer, 2.5" v. c.
- 1" titanium compression driver, 1.7" v. c.
- High quality analog input board
- Soft limiter and RMS protection
- Baltic birch cabinet
- Maximum output per size on the market

The TT08-A is by far the smallest member of the TT+ family, whilst being the most flexible and powerful tool in its class: from live sound to playback and monitoring, corporate events and broadcast studios. The TT08-A offers an incredible maximum sound pressure level of 128 dB. Its performance efficiency is almost 3 dB higher than many larger 10" speaker systems and indeed comparable to many 12" systems.

### LONG FIELD MONITORING

The other side of the cabinet presents a 20° angle perfect for long field monitoring applications.

Two different angles for near field or long field monitoring. Pole mount, fly bars, side M10 suspension points.

### NEAR FIELD MONITORING

One side of the cabinet presents a 40° angle for near field monitoring applications.



# TT052-A

## ACTIVE ULTRA COMPACT HIGH OUTPUT SPEAKER

The TT052-A is an extremely compact, active loudspeaker specifically designed for indoor applications where the audio beam must be directed towards specific zones. It is equipped with two 5" neodymium woofers and a 1" compression driver. Thanks to its constant directivity horn and high volume output, the TT052-A can be used to guarantee the perfect intelligibility in critical environments.

230V p/n 13000245  
115V p/n 13000246



*The*  
**READERS' CHOICE**  
AWARDS 2013

**WINNER**



### FULLY FEATURED INPUT BOARD

TT051-A and TT052-A are equipped with a state of the art input board which features: XLR In/Out, Volume control, Eq. switch for wall mounting, Hi-pass filter switch, RDNet ready, RDNet bypass, 4 status LEDs, Powercon In/Out

- 300 Watt, 2 way amplification
- Heavy duty multi-functional cabinet
- 2 x 5" low distortion woofer
- 1" neodymium compression driver, 1.5" v.c.
- DSP processing
- Wall mount EQ, High pass EQ
- RDNet READY



A dedicated processing area is available through the optional RDNet input board. Remote monitoring, special custom equalisations, high and low pass, single way solo and mute, and many other options. All available on RDNet.



### RENTAL PROOF

Combined to the AC TT051/52 pipe clamp TT051-A and TT052-A are the perfect tools for the rental company. In a few seconds, the right sound spot in the desired direction.

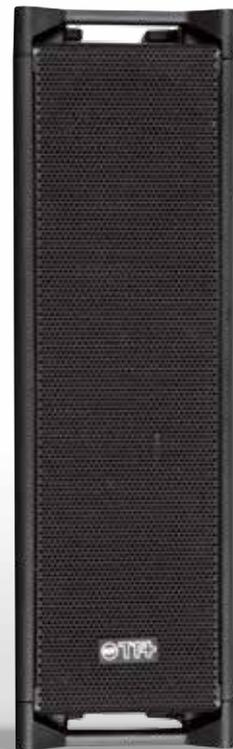
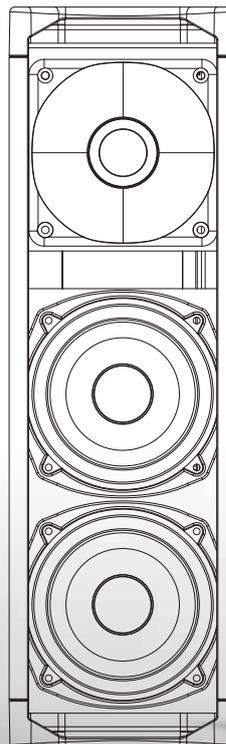



# TT051-A

## ACTIVE ULTRA COMPACT WIDE DISPERSION SPEAKER

The TT051-A is an ultra compact, active loudspeaker designed specifically for high quality indoor nearfield sound amplification. It is equipped with a 300 W digital amplifier, 150 W for the low frequencies and 150 W for the high frequencies. A powerful 5" neodymium woofer and a 1" aluminium dome tweeter loaded to a wide dispersion constant directivity horn provide an extensive coverage.

230V p/n 13000243  
115V p/n 13000244



READY



### MODULAR MECHANICS

Special integrated side mechanics with a unique quick lock system has been developed to provide a fast and easy set up of the speakers, offering an outstanding application flexibility.

### ROTATABLE LOGO

The TT051-A and TT052-A are equipped with rotatable logo to be used in vertical or horizontal position.



- 300 Watt, 2 way amplification
- Heavy duty multi-functional cabinet
- 5" low distortion woofer
- 1" titanium dome tweeter
- DSP processing
- Wall mount EQ, High pass EQ
- RDNet READY



A dedicated processing area is available through the optional RDNet input board. Remote monitoring, special custom equalisations, high and low pass, single way solo and mute, and many other options. All available on RDNet.

### ■ POLE MOUNT READY

Combined to the AC TT051/52 pole mount TT051-A and TT052-A are easily combined to a subwoofer or pole mounted on a floor stand.

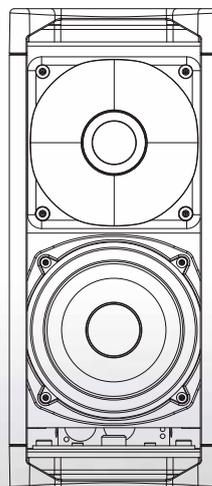

# TT45-SMA

## ACTIVE HIGH OUTPUT STAGE MONITOR

The TT45-SMA is a very high output, high performance, active stage monitor. Perfectly flat amplitude response, extended bass reproduction and incredible output make this monitor unique in the market. The TT45-SMA distinguishes itself for vocal clarity, accurate and detailed high frequency reproduction, perfect feedback stability. The cabinet angle and the 90° x 45° uniform directivity provide optimal coverage in medium and large sized stages. TT45-SMA are designed to work in pairs to provide exceptional tour grade monitoring to the most demanding artists. The TT45-SMA features 1500 Watt digital amplification power with integrated onboard signal processing and transducers protections.

- 1500 Watt, 2 way digital amplification
- 2 x 12" high power neo woofers, 3.5" v. c.
- Horn loaded 1.5" throat titanium compression driver, 3" v. c.
- 90° x 45° coverage angle
- Soft limiter and rms protection
- Very low profile
- Maximum gain before feedback
- Baltic birch cabinet
- Maximum output per size on market

230V p/n 13000192  
115V p/n 13000193



### WOOFERS

The loudspeaker's low frequency section comprises two 12" high power neodymium vented woofers. The two transducers are driven in parallel for a tight and powerful bass response. In the low midrange frequency region only one of the two transducers is driven in order to avoid side cancellations.

### INSIDE VIEW

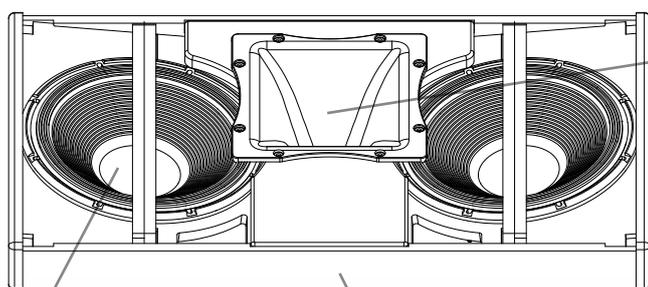

#### ■ HIGH POWER LF

The loudspeaker's low frequency section comprises two 12" high power neodymium woofers in clam shell configuration.

#### ■ DIGITAL AMPLIFICATION

The TT45-SMA is powered by a 1500 Watt digital 2 way amplifier: 1000 Watt for the low frequencies and 500 Watt for the high frequencies.

#### ■ PRECISION HF

The high frequencies section features a 90° x 40° horn loaded compression driver, 3" voice coil.

#### ■ TOURING GRADE CABINET

The cabinet is constructed in Baltic birch plywood and protected with high quality textured coating. It features two recessed side handle on the sides and a heavy duty metal grille with acoustical high quality foam backing. Low profile rubber feet prevent cabinet damages.

### COMPRESSION DRIVER



A new high performance 3.0 inch diaphragm compression driver with a 1.4 inch exit throat deliver perfectly natural midrange and high frequency.

The diaphragm is precision formed from pure titanium, the suspension is based on a vented and damped design in order to provide very low distortion.



# TT25-SMA

## ACTIVE HIGH OUTPUT STAGE MONITOR

The TT25-SMA is a high performance, coaxial stage monitor.

The very linear curve response, the consistent coverage, the acoustic output make the TT25-SMA the professional choice for most demanding situations. The voicing is accurate and deep, the sound transparent in the mids and extremely accurate at very high frequencies. The size is compact and the profile very low for a discrete stage professional appearance. Loop through output and power panel on opposite side to minimize cable runs on stage. By producing flat amplitude and phase responses, full range bandwidth and exceptional impulse response, the TT25-SMA far exceeds the capabilities of conventional stage monitors.



### COAXIAL SYMMETRY

A coaxial loudspeaker presents a response behaviour that is symmetric about its axis. For stage monitoring purposes the coaxial characteristics provide near perfect monitoring. You can move left, move right, go forward and go back and you will hear the same, uniform sound. The new 15" coaxial neodymium transducer is the result of the latest refinement in years of RCF transducers experience, featuring a 3.5" voice coil, titanium dome, compression driver. A massive outside ring neodymium magnet drives the transducers for a controlled mid-bass and extreme precision in high frequency reproduction.

- 750 W digital switching amplifiers
- 60° conical, constant directivity coverage angle
- 15" neodymium woofer, 3.5" v. c.
- 1.5" neodymium c. driver, 2.5" v. c.
- High quality analog input board
- Soft limiter and RMS protection
- Very low profile
- Baltic birch cabinet
- Very high output

### INSIDE VIEW

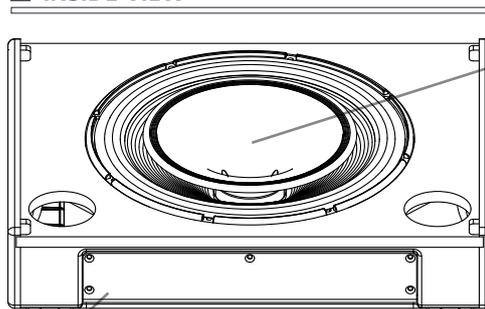

### HIGH POWER LF

The horn on a coaxial 15" neodymium cone driver with 64 mm diaphragm exhibit constant Q. The beamwidth remains consistent across the horn's operating frequency range and coverage. Frequency response is uniform across the specified beamwidth, with minimal side lobes.

### DIGITAL AMPLIFICATION

The amplifier section features 750 W switching power supply module and phase corrected control electronics. The high quality analog input board provides linear phase crossovers, system equalisation, fast limiter, RMS limiter and configuration control preventing driver over-exursion and assuring high sound pressure levels with minimal power compression



# TTS56-A

## ACTIVE HIGH POWER SUBWOOFER

The TTS56-a is a high power, high output active subwoofer system that sets a new standard in the touring sound reinforcement. The new 21" neodymium design represent the result of many years dedicated in pioneering new solutions for the transducers technology. The integration of the 6800 Watt , 2 channel digital amplification and the advanced digital processing set a new standard for distortion, noise and thermal efficiency.

230V & 115 V p/n 13000190

- 6800 Watt (2 x 3400 Watt digital amplifiers)
- 2 x 21" high power neodymium woofers, 4.5" v. c.
- 96 Khz, 32 bit DSP processing
- RDNet ON BOARD
- Time delay alignment
- Cardioid preset for groups
- Tour grade Baltic birch cabinet
- Maximum output per size on market



### THE NEW 21" TRANSDUCER DESIGN FEATURES:

Very high force, neodymium magnet assembly  
115 mm diameter, 33 mm length, inside-outside copper voice coil reinforced silicon double spiders  
carbon fiber doped water resistant cone heavy duty aluminum basket magnet assembly complex ventilation for minimum power compression.

## INSIDE VIEW

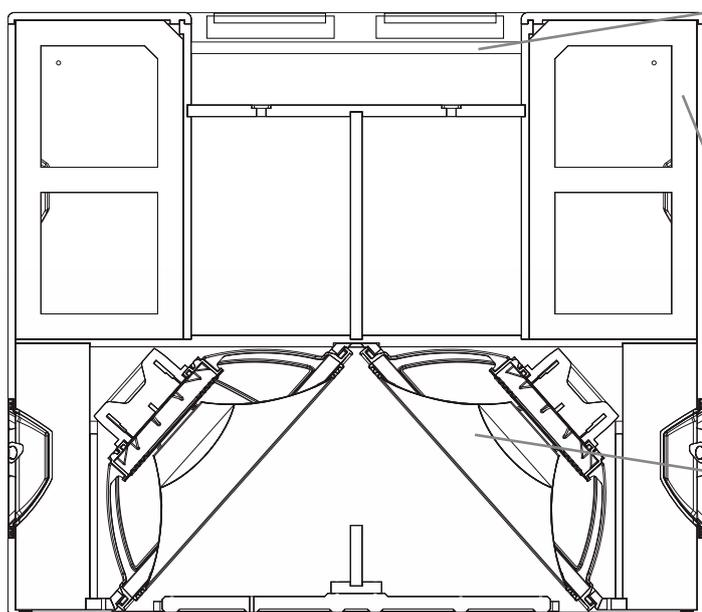

### POWER PLATFORM

The power section comprises 2 x 3400 watt digital amplifiers, a state of the art 32 bit floating point Dsp processing, time delay setting, network board, high quality analog inputs.

### TOURING GRADE CABINET

The cabinet is in Baltic birch and the internal structure is heavily braced to survive to long term use and transportation. The weight of the system is less than many similar size passive competitors.

### BASS-REFLEX LOADING

The 2 x 21" woofers, in a clam shell loading configuration, provide a very tight and powerful extended bass response.

## INPUT BOARD



The input section provides:

- In/Out XLR connectors
- Crossover Out XLR connector
- System sensitivity control
- crossover set-up (60 Hz - 90 Hz )
- High pass set-up (30 Hz - 45 Hz)
- 4 status LEDs
- RDnet Ethercon In/Out connectors

THE INPUT SECTION PROVIDES A SPECIAL SWITCH TO CREATE A CARДИOID CONFIGURATION WHEN TTS56-A SUBWOOFERS ARE USED IN GROUPS OF THREE

## TRANSDUCERS

The TTS56-A features two 21" high power neodymium woofers. A new 21" transducer has been specifically designed for the application. The woofer provides very high power handling, low distortion at large excursions and very light weight for the power. The clam shell acoustical configuration provides very high outpout, bass reflex quality sound, very compact footprint.



#### RDNET

The TTS56-A is equipped with a dedicated RDnet networking board. It is possible to monitor all the system parameters, from the input to the status of each amplifier, to address to single cabinets or groups of cabinets specific presets or modifications of parameters like gain, equalisation or delay.

#### POWER AMPLIFIERS

The TTS56-A amplifier section features 2 x 3400 Watt highly advanced digital amplifier modules. The power amplifiers and the input board are housed on a heavy duty aluminum panel suspended from the main cabinet with flexible mounts to obtain the best insulation from vibrations of the electronic parts.

Each module features:

- Power Factor Correction (PFC)
- Separated power supply and amplification
- High efficiency, very low consumption
- Comprehensive, smart protection features: thermal, over-current, non audio signals
- Two "on board" ventilation fans



# TTS36-A

## ACTIVE HIGH POWER SUBWOOFER

The TTS36-A is a high power, high output active subwoofer system that sets a new standard in the touring sound reinforcement. The new 18" neodymium design represent the result of many years dedicated in pioneering new solutions for the transducers technology. The integration of the 4000 Watt , 2 channel digital amplification and the advanced digital processing set a new standard for distortion, noise and thermal efficiency.

230V & 115 V p/n 13000272



### INPUT BOARD

The input section provides:  
In/Out XLR connectors, Crossover Out XLR connector, System sensitivity control, Crossover set-up (90 Hz - 120 Hz ), High pass set-up (35 Hz - 50 Hz), 4 status LEDs, RDnet Ethercon In/Out connectors

- 4000 watt (2 x 2000 Watt digital amplifiers)
- 2 x 18" high power neodymium woofers, 4.5" v. c.
- 96 KHz, 32 bit DSP processing
- RDNet ON BOARD
- Time delay alignment
- Bass reflex design, Cardioid preset for groups
- Tour grade Baltic birch cabinet
- Maximum output per size

### POWER PLATFORM

The power section comprises 2 x 2000 watt digital amplifiers, a state of the art 32 bit floating point Dsp processing, time delay setting, network board, high quality analog inputs.

### BASS-REFLEX LOADING

The 2 x 18" woofers, in a separate chambers bass reflex configuration, provide a very tight and powerful extended bass response.

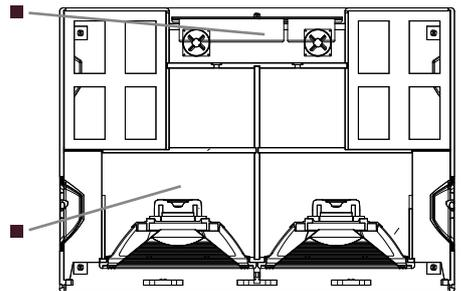

# TTS26-A

## ACTIVE HIGH POWER SUBWOOFER

The TTS26-A is a very compact powerful subwoofer designed for a variety of professional fixed or portable sound applications. It is the perfect complement the TTL11A column array system.

Two high power 15" neodymium woofers powered by a 3400 W digital amplifier deliver a perfect and bass punch for live music applications.

230V p/n 13000241  
115V p/n 13000242



ON BOARD



**WOOFERS**  
- 2 x 15" high power vented neo woofers, 4" voice coil  
- Minimum weight basket design

**TTL11A MECHANICS READY**  
The TTS26-A is equipped with special mechanics to mount the TTL11A on it.



- 3400 Watt digital amplification
- 2 x high power 15" neo woofers, 4" v.c.
- 96 KHz, 32 bit DSP processing
- RDNet ON BOARD
- Time delay alignment
- Cardioid preset for groups
- TTL11A mechanics ready
- Maximum output per size

### POWER PLATFORM

The amplifier section features 3400 W switching power supply (1700 W + 1700 W), a state of the art 32 bit floating point Dsp processing, time delay setting, network board, high quality analog inputs.

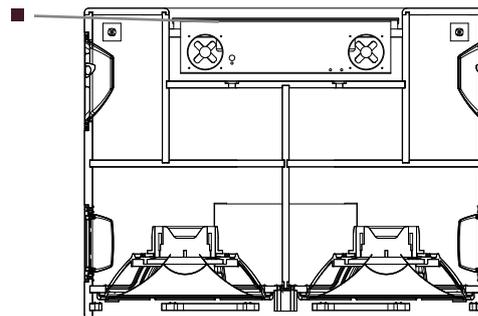

Sound systems design for almost any application benefit from the addition of extended low frequency or sub bass. True natural reproduction of music requires that the sound system's output should extend into the lowest octaves of the audible spectrum.



# RNet Control 8

## 8 OUTPUT MASTER UNIT

The RNet Control 8 is a real-time monitor and control system able to manage up to 256 devices linked 32 per bus in 8 buses.

All the data collected from the slaves are delivered to the sound engineer by USB in a local installation or by Ethernet from remote locations. The interface can be directly connected to the DSP on board of every TT+ product through the exclusive RNet protocol making it possible to address in single cabinets or groups, specific presets or modification parameters in real-time. The key point of RNet Control 8, in fact, is to ensure minimum refresh time (at least 5 per second) of all the system data performance like RMS signals, compressor activity, temperature, fans speed and warnings. Data transfer can be routed also through the provided xlr connectors enabling the control of the system on traditional multi-cored cables.

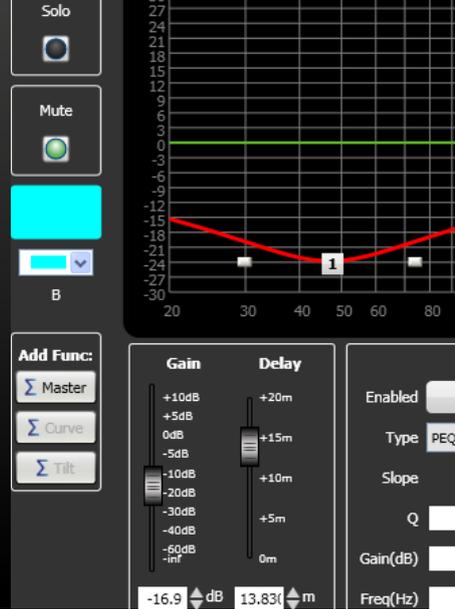

230V / 115V  
p/n 17170154



**TOPOLOGY FLEXIBILITY**  
The RNET CONTROL 8 unit can manage up to 8 subnets. Up to 32 audio devices can be connected to each subnet (8 subnets x 32 = total 256 audio devices).

**COMMUNICATION FLEXIBILITY**  
The link between the PC and the RNET CONTROL 8 unit can be made through USB port or ETHERNET port.



- RNet control and monitoring in a single device by Ethernet or USB communication
- Up to 8 subnet of up to 32 slaves devices
- Automatic network configuration and registration
- Slave devices status and functions real time control
- Monitoring and display of faults and warnings sent from slave devices
- User configurations storage and recall

### REAR VIEW



### CONTROL FLEXIBILITY

The PC cyclically requires the RNET CONTROL 8 unit the operating state of audio devices that make up the communication network. All data are collected by the central unit that performs a sequential scan of all audio devices. Digital address allocation is automatic. Information relating to the functioning of all audio devices is acquired in real-time, feature that allows a network global view. It is possible to check each single audio device and edit its parameters (e.g. output level, mute, equalization, delay, etc.) by using the PC software. The audio device overall configuration can be saved as file in the PC and later reloaded. It is possible to synchronize all parameter values of the RNET CONTROL 8 unit to the ones of the PC software preset.



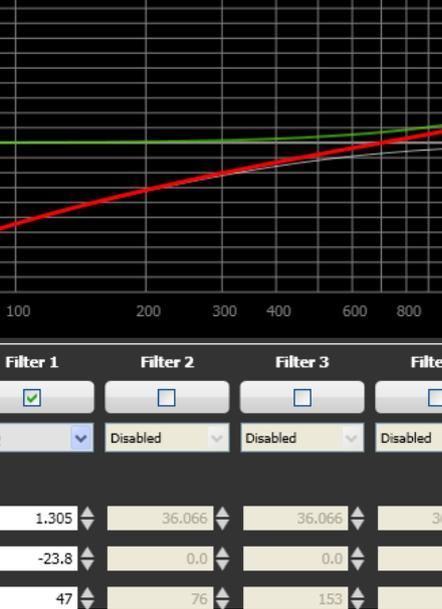

# RNet Control 2

## 2 OUTPUT USB MASTER UNIT

The RNet Control 2 is a hardware interface to connect RCF RNet compatible devices (TTL55-A, TTL33-A II, TTL31-A II, etc.) to a Personal Computer (PC) by means of an USB connection.

The RNet system was purposely developed to create a data network for monitoring and command of more systems. The RNet Control 2 unit can manage up to 2 subnets. Up to 32 devices can be connected to each subnet (2 subnets x 32 = total 64 devices).

The addressing of the various devices is handled automatically by RNet Control 2 interface. Each device is assigned a unique address during the power on procedure of network.

USB POWERED  
p/n 17170163

### DOWNLOAD THE SOFTWARE

The RNet 2.0 software can be found as free download on RCF's website in the section: LOGIN. Once the customer has registered he can visit the Download section and access the software.



- RNet control and monitoring in a single device by USB communication
- Up to 2 subnet of up to 32 slaves devices
- Automatic network configuration and registration
- Slave devices status and functions real time control
- Monitoring and display of faults and warnings sent from slave devices
- User configurations storage and recall

### RNET

We have developed a dedicated networking board for the latest TT+ products. Using our proprietary RNet protocol is possible to monitor all the system parameters, from the input to the status of each single amplifier. Having a Dsp on board of each cabinet, it is possible to address to single cabinets or groups of cabinets specific presets or modifications of parameters like gain, equalisation or delay. The RNet protocol is based on RS-485 communication protocol, it is very stable and it is possible to send and receive data on a simple XLR cable.

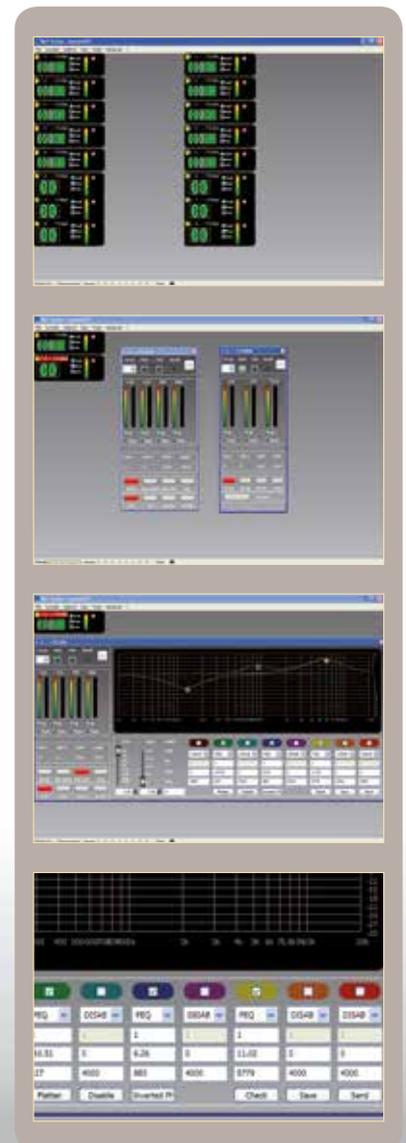

### REAR VIEW



# RNet 2.2

## SOFTWARE

RNet software enables to remotely control and manage professional speakers and audio objects/devices. Each single device, with its own built-in communication board, microcontroller and dsp, is an active part of the brain of the system, able to store presets, receive commands and continuously send status information.

RNet 2.2 is based on many years of research and development making the management of complex audio systems simple and intuitive. RNet 2.2, entirely designed and developed by RCF engineering team, includes several new functions as well as multiple improvements and adjustments. RNet 2.0 includes its control software, all supported devices (with new firmware updates) and Control 2 and Control 8 devices.

### DOWNLOAD THE SOFTWARE

The RNet 2.2 software can be found as free download on RCF's website in the section: LOGIN. Once the customer has registered he can visit the Download section and access the software.

#### ■ AUTOMATICALLY SCANNING

When online the RNet Control 8 unit sequentially scans all audio devices, which are automatically assigned to digital addresses. The loudspeaker object are automatically added to the software synoptic, and the software shows an object for each loudspeaker (or any other audio device) that has been found.

In the object window you get different indications of the speaker and also switch functions such as Mute & Solo. There are two indicators of the signal level: the first is a bar, the second a single LED to indicate the peaks.

The display also indicate with a yellow alert symbol if there is a wrong setting in the system.



#### ■ OBJECT WINDOW

The object window includes the Group parameter, the Mute and Solo commands and the Recall indicator.

In the center there is level bars, a pair per each speaker way: Low, Low, Mid & High. In each pair the left bar indicates the signal level of its respective way, the right bar indicates the compressor operation.

The ok LEDs indicate that each speaker way is working properly and Mute switch are also accessible for the same window.

Speed indication of FAN 1 & FAN 2, internal temperature indication and Angle shows the loudspeaker (vertical tilt).

Settings for loudspeaker field (NEAR / MID NEAR / MID FAR / FAR)

Cluster loudspeaker number setting.



#### ■ SIGNAL LEVEL & DELAY SETTING

Setting of signal level attenuation (value: from 0 to -20 dB). Signal Delay setting, express in range of 0

#### ■ EQUALIZER DISPLAY

A graphical display of your different EQ settings

#### ■ SELECTABLE EQ FUNCTIONS

Settings of EQ types, Flatten, Disable & Inverted PH buttons. Furthermore Save and Send options. Save function: Sends and stores the equalization to the selected speaker. Send function: Sends (without storing) the equalization to the selected loudspeaker.



# RDNET 2.2



## AC RD-NET IN-OUT PLUG - p/n 13360176

With AC RD-NET IN/OUT Plug - modules installed, RCF TT+ systems can be remotely controlled and monitored using RD Net software. A Windows-based application, this interface provides an intuitive, easy to use platform for system configuration and operation of RCF TT+ devices in the network chain. RD Net System Architect enables the unified layout of onscreen product control surfaces, and simple preset configuration of an entire system made up of RCF TT+ products. Advanced remote control and diagnostic capabilities, control panel for 8 band full parametric Eqs, delays, and the recall of presets on all connected RCF TT+ devices are included.

Compatible with TT1-A, TT2-A, TT5-A, TTL11A, TT051-A, TT052-A

## INSTALLATIONS: MULTIPLE IMPROVEMENTS FOR A WIDE RANGE OF APPLICATIONS

1. New bypass override flag management. The Bypass Override function, masked for touring or live applications, is easily activated for installations. Totally reviewed the management of the device in the network and his management.
2. Is now selectable the Ethernet port to be connected.
3. Multiple concurrent Control 8 Interfaces managed to create larger systems.
4. New monitoring features added for safety and evacuation systems.
5. "Object status retrieve" command added.
6. Management software for AX8042 added. AX 8042 is a high quality, highly versatile digital matrix-mixers designed on a powerful DSP platform, dedicated for installed sound and commercial audio applications.



## ADDED FEATURES

1. Support to the last generation of speakers (TT1, TT2, TT5 e TTP5)
2. Elliptic, Bessel and Linkwitz Riley filter types in user EQ.
3. Gain range in user equalisation improved, now ranges from -90 dB to +10 dB.
4. Phase curve added to equalisation curve. Visualisation enabled/disabled by a specific button.
5. New Auto test function.
6. Black skin, settled as start software skin.



## INSTALLATIONS: MULTIPLE IMPROVEMENTS FOR A WIDE RANGE OF APPLICATIONS

On several speakers major firmware updates have been developed to offer:

1. Improved impulse and phase response
2. Advanced bass response alignment
3. Innovative dynamics processing algorithms
4. Improved noise floor
5. Increased SPL output on specific speakers models



## IMPROVED SAFETY AND FULL CONTROL AT VERY LONG DISTANCES

1. Completely redesigned Offline and Online operating mode for a safe system administration.
2. Revised mute management logic rules.
3. Improved RDNet protocol communication and error correction.
4. Logic ID support for a "Faulty device tolerant" network operation.
5. New Control 8 firmware release. With this release objects registering has been improved, with a significantly higher reliability compared previous releases (objects registrations is remarkably faster and safer thanks to the implementation of separated threads for each sub-network).



## EASY TO START, INCREDIBLY POWERFUL WHEN EXPANDED

1. Easier system registration and start up.
2. Added Multi-Controller support: up to 20 concurrent Control 8 interfaces allowed to get up to 160 RDNet ports.



## TOURING APPLICATIONS: OFF-LINE EDITING AND SELF-RECOGNITION FOR SUPERIOR PERFORMANCES

1. Totally redesigned editing support for off-line system design.
2. Logic ID introduced. Changes of the physical layout do not interfere with the real time system operation.
3. Redesigned and improved communication protocol for superior reliability and robustness.
4. Faster "multicast" commands introduced for better control of large systems.
5. Concert mode password added.



# PROJECTS AND CUSTOM DESIGNS



## EASE DATA

**WEBSITE DOCUMENTATION**  
The RCF Website provides Manuals, Specsheets, Drawings, EASE data and GLL files, all available for download.



### STATE OF THE ART FACTORY

RCF is an integrated designer and manufacturer, with the ability to provide top quality transducers or complete speaker systems, both passive and active, with integrated digital amplifier assemblies.

This characteristic is a major advantage in terms of product performance and competitiveness, since each time a new speaker cabinet is planned, the design of its transducer is carried-out simultaneously, in order to deliver uncompromised quality from the system.

### CUSTOM PRODUCTS AND MONITORING OPTIONS

All TT+ range of products is available with custom solutions to fulfil every system specification or requirements.

Special optional control boards have been developed for various requirements like large systems real time monitoring, fault reports, GP inputs and outputs.

### SYSTEMS MODELING - EASE SIMULATIONS

An audio system design for environments like stadia, sports arenas, theatres, auditoriums, airports, places of worship — as well as concerts and live events — is often carried out taking into consideration the acoustics of the environment, the architectural and installation constraints, the maintenance costs and, on top of everything, the user's requirements. RCF R&D also has a dedicated automatic system for the high resolution measurements of the acoustical 'footprint' of the speakers, based on 360° balloon (i.e. GLL speaker data) required by EASE acoustic modelling software. This data is available both from the RCF website and the acoustic simulation software company.

### ENGINEERING SUPPORT GROUP

The extensive range of RCF products enables the Engineering Support Group to submit multiple design solutions optimised and tailored according to budget and the requested performance spec. The design proposals are based on supplied venue details, including environmental acoustic simulation, product list, block diagram and speaker coverage mapping.

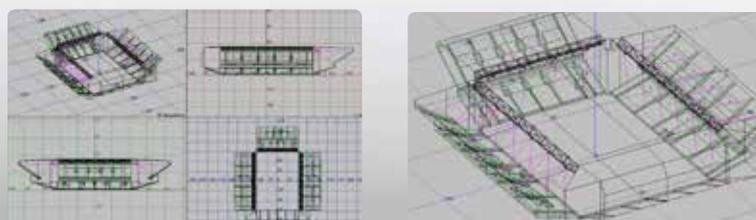

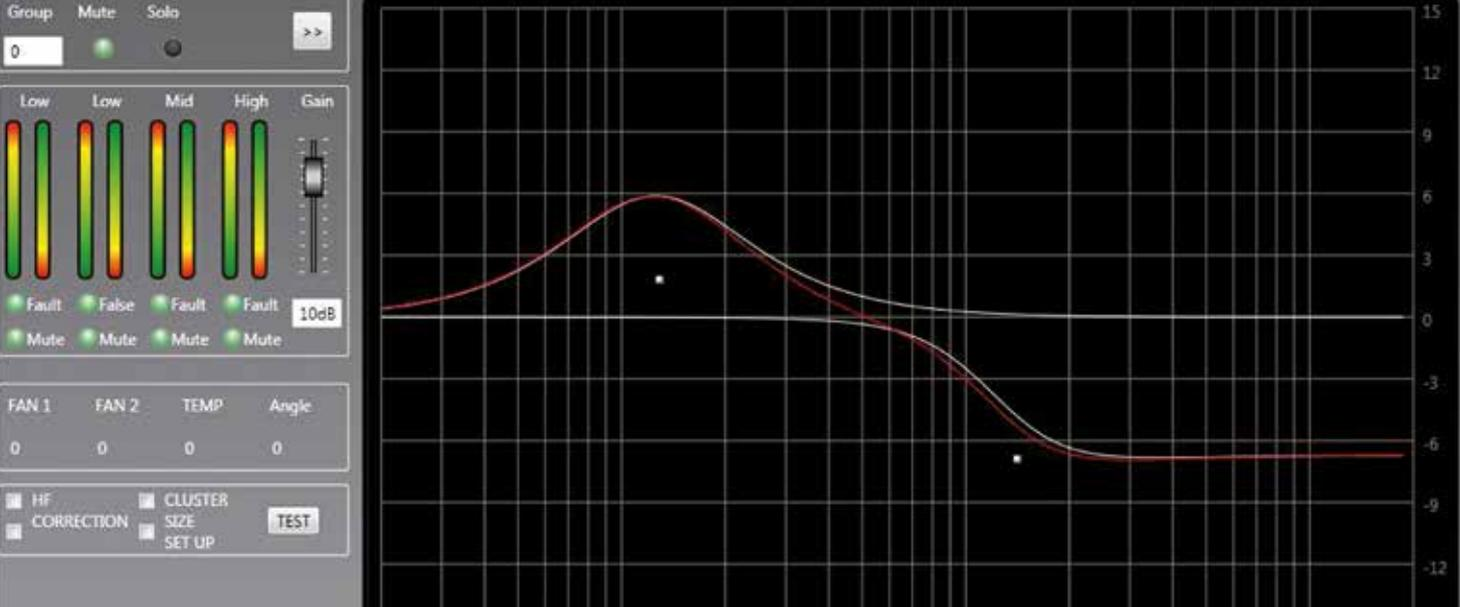

# SHAPE DESIGNER

## RCF SHAPE DESIGNER

In order to assist with the set up procedures for the TT+ Line Array Systems, RCF has developed a complete prediction software package. The software enables a complete two dimensional simulation of the behaviour of the cabinets arrays and also suggest the correct subwoofers combination. The system curvature angles and the sound projection data are computed with maximum sound pressure levels for the given design.

The rigging menu provides data for weight, centre of gravity and length of the array configuration. Rigging points and rigging hardware configurations are also computed.

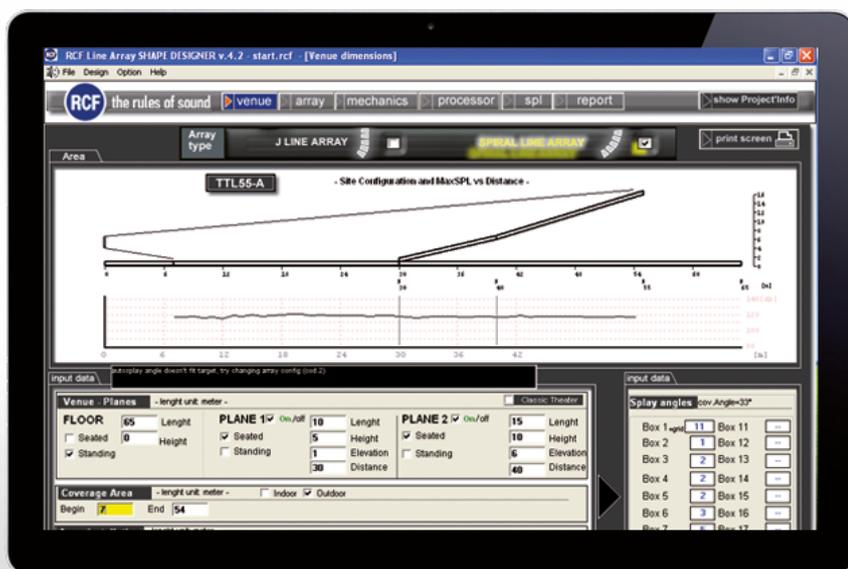
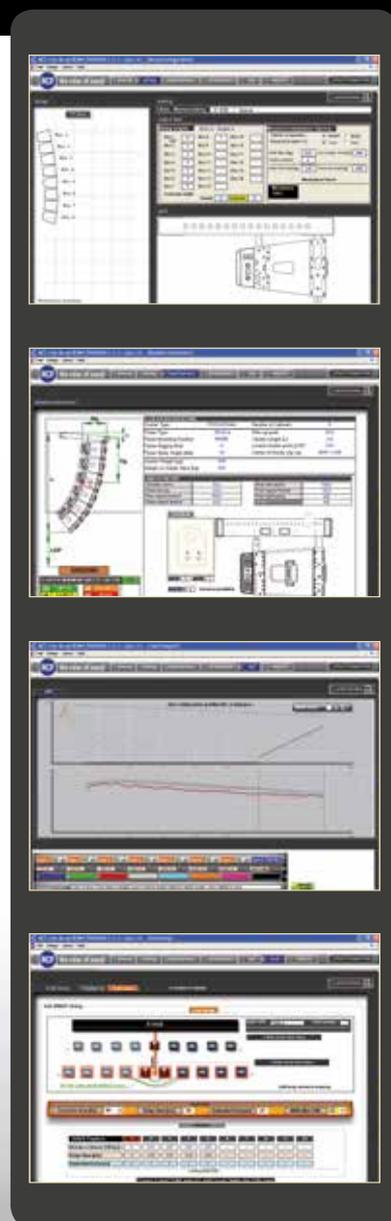

# WEATHERPROOF PASSIVE SPEAKERS

The WPTT+ line is a multi-use loudspeakers range specifically outfitted to serve portable and permanent applications. The cabinets come with superior features. These models are especially designed to withstand exposure to weather without damage or loss of function of the speakers.

## TTL33 WP LINE ARRAY MODULE

p/n 13000248

- Very compact size
- Maximum output per size available on the market
- Wide, constant directivity, horizontal coverage angle
- 6 high power neodymium transducers
- Minimum weight
- Watertight multi-pole connector IP67
- LICC (Low Impedance Compensated Crossover Network)
- Baltic birch cabinet



## TTL31 WP LINE ARRAY MODULE

p/n 13000250

- Very compact size
- Maximum output per size available on market
- Wide, constant directivity, horizontal coverage angle
- 4 high power neodymium transducers
- Minimum weight
- Watertight multi-pole connector IP67
- LICC (Low Impedance Compensated Crossover Network)
- Watertight multi-pole connector



## TTL12-S WP ARRAY SUBWOOFER MODULE

p/n 13000253

- Precise rigging system simplifies integration in flown or ground-stacked arrays
- Very compact size
- Maximum output per size available on market
- Minimum weight
- High power full neodymium 12" transducer
- Watertight multi-pole connector IP67
- Baltic birch cabinet



■ GRILLE WITH DOUBLE PAINTING, FOAM AND RAIN SLIM COVER



■ POLYUREA PAINTING INSIDE AND OUTSIDE

The grill comes with a double painting to strengthen the durability features a foam layer and a water resistant clothbacking for extra protection against the rain.

We utilizes a special heavy duty polyurea paint to create a very thick full coating of the cabinet making it highly resistant to scratches and bumps. Polyurea lasts longer than paint and epoxy and maintenance services and costs are therefore reduced. Polyurea's are very durable and it can be used as a waterproofing and protective coating from daily operations. Polyurea has a high tolerance for substrate and environmental humidity and temperature.



## TT22 WP

### TWO-WAY PASSIVE SPEAKER

p/n 13000252

- Very compact size
- Maximum output per size available on the market
- Minimum weight
- Wide, constant directivity, horizontal coverage angle
- High power neodymium transducers
- Dual function: built in passive xover or external bi-amp
- LICC (Low Impedance Compensated Crossover Network)
- Watertight multi-pole connector IP67



## TTS28 WP

### POWER SUBWOOFER

p/n 13000251

- Very compact size
- Maximum output per size available on market
- Minimum weight
- 2 x high power full neodymium 18" transducers
- Watertight multi-pole connector IP67
- Baltic birch cabinet



■ IP 67 CONNECTORS



■ INOX STEEL SCREWS & MECHANICS WITH PROTECTIVE FILM

An IP number is used to specify the environmental protection of enclosures around electronic equipment. These ratings are determined by specific tests. The IP is composed by two numbers, the first referring to the protection against solid objects and the second against liquids. The higher the number, the better the protection. The connectors have an IP rate of 67, which means: Totally protected against dust and Protected against the effect of immersion between 15cm and 1m.

All screws used on the WPTT+ boxes are Inox, this material is also known as stainless steel, a metal that is strong, durable and often used for applications where you need a strong protection against rust and different weather conditions. The surface of the mechanics has a protective film useful against shifting weather conditions and more resistant against unwanted scratching. It also secures a high work reliability of the product in applications where the surface is constantly under pressure.

# ACCESSORIES



**p/n 13360136  
AC RAIN COVER TTL55**

Rubber rain cover protection for TTL55-A amplifiers.



**p/n 13360083  
AC RAIN COVER TTL33**

Rubber rain cover protection for TTL33-A and TTL33-A II amplifiers.



**p/n 13360142  
AC RAIN COVER TTL31**

Rubber rain cover protection for TTL31-A and TTL31-A II amplifiers.



**p/n 13360137  
AC RAIN COVER TTS56**

Rubber rain cover protection for TTS56-A amplifiers.



**p/n 13360134  
COVER TTL55**

Single protection for one TTL55 array module. Includes a soft bag on top to store cables and spare pins. To be used in conjunction with TTL55-A single kart.



**p/n 13360135  
COVER TTS56**

Protection cover for for one TTL56-A subwoofer. Best used in conjunction with TTL56-A front wood cover.



**p/n 13360054  
COVER TTS28**

Protection cover for TTS28 and TTS28-A.



**p/n 13360053  
COVER TTS18**

Protection cover for TTS18 and TT18-A.



**p/n 13360230  
COVER TTS26**

Protection cover for TTS26-A.



**p/n 13360056  
COVER TT25**

Protection cover bag for TT25 and TT25-A.



**p/n 13360055  
COVER TT22**

Protection cover bag for TT22 and TT22-A.



**p/n 13360096  
COVER TT08**

Protection cover bag for TT08 and TT08-A.



**p/n 13360169  
COVER TT051-A**

Protection cover bag for TT051-A.



**p/n 13360170  
COVER TT052-A**

Protection cover bag for TT052-A.



**p/n 13360140  
FRONT WOOD COVER TTS56**

Quick lock wood front protection for TTS56-a subwoofer. Compatible under the TTS56-A cover.



**p/n 13360157  
AC SLED56**

TTS56-A sub's hard nylon side reinforcements to facilitate ground transportation.



**p/n 13360154  
LIFT KART TTL55**  
Lifting trolley for TTL55-A arrays.



**p/n 13360120  
FLY BAR TTL55**  
Suspending bar for TTL55-A line array system (including Pickup Point and Quick Lock pins).



**p/n 13360052  
FLY BAR TTL33**  
Suspending bar for TTL33-A and TTL33-A II array systems.



**p/n 13360063  
FLY BAR TTL33 SHORT**  
Short suspending bar for TTL33-A and TTL33-A II array system (including 2 Quick lock pins)



**p/n 13360076  
FLY BAR TTL31**  
Suspending bar for TTL31-A and TTL31-A II array system



**p/n 13360131  
LINK BAR TTL55-33-31**  
Transition Frame to connect up to 8 TTL33-A/TTL33-A II or TTL31-A/TTL31-A II under a TTL55-A line array system.



**p/n 13360057  
STCK BAR TTL33**  
Accessory to add to Fly bar TTL33 for stacking option on sub. Quick lock pins to be added.



**p/n 13360079  
STCK BAR TTL31**  
Accessory to add to Fly bar TTL31 for stacking option on sub. Quick lock pins to be added.



**p/n 13360162  
AC TTS18**  
Accessory to link subwoofer TTS18-A to Fly bar TTL33 and the TTL33-A/TTL33-A II module to the TTS18-A.



**p/n 13360175  
AC ASSEMBLY TTL11AH/AB**  
Accessory to link TTL11A-H to TTL11A-B. (including 2 quick lock pins)



**p/n 13360177  
AC ASSEMBLY TTL11/TTS26**  
Accessory to link TTL11A system to TTS26-A subwoofer. (including 4 quick lock pins)



**p/n 13360203  
FLOOR STAND TTL11A**  
Accessory to mount TTL11A on the floor.



**p/n 13360122  
AC 4PIN TTL55**  
4X TTL55-A module pin set. Spare set in case original pins are damaged or lost.



**p/n 13360132  
AC 4PIN FLY BAR TTL55**  
4X TTL55-A fly bar pin set. Spare set in case original pins are damaged or lost.



**p/n 13360060  
AC 4PIN TTL33**  
4 quick lock pins kit for TTL33-A array system.



**p/n 13360077  
AC 4PIN TTL31 NXL23**  
4 quick lock pins for TTL31-A and NX L23-A array system.

# ACCESSORIES



**p/n 13360129**  
**HOIST SPACING CHAIN TTL55**

Hoist Connector Chain to distance the motor and the chain bag from the suspending bar keeping in vertical balance the system.



**p/n 13360128**  
**SAFETY CHAIN TTL55**

Safety chain for ttl55 array system



**p/n 13360133**  
**AC WOOD KART TTL55**

TTL55-A front kart



**p/n 13360059**  
**KART TTL33**

Kart to transport 4 TTL33-A/TTL33-A II modules with the fly-bar connected.



**p/n 13360226**  
**AC RDNET INPUTS TTL33-A II**

Accessory to convert TTL33-A input board to TTL33-A II.



**p/n 13360227**  
**AC RDNET INPUTS TTL31-A II**

Accessory to convert TTL31-A input board to TTL31-A II.



**p/n 13360130**  
**SHACKLE TTL55**

3/4" Shackle ~ 4-3/4 tons for TTL55-A array system. To be added to the flybar accessory in case the pick up is made with 2 motors.



**p/n 13360127**  
**FLY BAR PICKUP TTL55**

Spare pickup point (including 2 quick lock pins)



**p/n 13360143**  
**SHACKLE TTL33-TTL31**

5/8" SHACKLE ~ FOR TTL33-A/TTL33-A II, TTL31-A/TTL31-A II ARRAY SYSTEMS. To be added to the flybar accessory in case the pick up is made with 2 motors.



**p/n 13360108**  
**AC PRO15 V-BR**

Bracket for flying and wall mounting TT25-A or TT25 loudspeakers with pole and adjustable inclination.



**p/n 13360107**  
**AC PRO12 V-BR**

Bracket for flying and wall mounting TT22-A or TT22 with pole and adjustable inclination.



**p/n 13360106**  
**AC PRO8 V-BR**

TT08 and TT08-A flying and wall mount bracket with mounting pole and adjustable inclination.



**p/n 13360091**  
**AC TT25 V-BR**

TT25 and TT25-A wall mount brackets with adjustable inclination.



**p/n 13360090**  
**AC TT22 V-BR**

TT22 and TT22-A wall mount brackets with adjustable inclination.



**p/n 13360082**  
**AC TT08 H-BR**

Pair of horizontal bracket for mounting TT08 and TT08-A speakers on the wall.



**p/n 13360030**  
**AC DS4X**

Kit of 4 hooks for suspending fly track bar.



**p/n 13360171**  
**AC TT051/52 PIPE CLAMP**  
 Pipe clamp adapter for TT051-A and TT052-A.



**p/n 13360066**  
**AC M20-PLATE**  
 Threaded plate for M20 pole mount.



**p/n 13360172**  
**AC TT051/52 STAND ADAPTER**  
 Stand adapter for TT051-A and TT052-A.



**p/n 13360110**  
**AC PRO-PM**  
 Pole mount with ring lock



**p/n 13360178**  
**AC TTL11 WM-BR**  
 Accessory to mount TTL11A on the wall.



**p/n 13360067**  
**AC PM M20**  
 M20 pole mount for TT22, TT22-A, TT25 and TT25-A speakers.



**p/n 13360138**  
**AC POWER CABLE 6X TTL55**  
 AC Cable to power up to 6 TTL55-A or TTS56-A amplifiers.



**p/n 13360034**  
**AC PMA**  
 Speaker pole mount.



**p/n 13360146**  
**AC POWER EXTENSION TTL55**  
 AC power cable extension 20 meters.



**p/n 13360111**  
**AC PRO-LF**  
 Steel professional adapter sleeve for loudspeaker stands.



**p/n 13360145**  
**AC POWER BOX 6XTTL55**  
 European stage box to power 6 ttl55-a line array modules.



**p/n 13360109**  
**AC PRO-FS**  
 Steel speaker floor stand with folding base and telescopic rod. Tube diameter 35mm. Load capacity up to 50kg.

USA **p/n 13360147**



**p/n 13360033**  
**AC NL4F 4X**  
 Kit of 4 male speakon connectors 4 poles.



**p/n 13360035**  
**AC S260**  
 Steel speaker floor stand with folding base and telescopic rod, tube diameter 35mm. Equipped with damping system and safety plug; central die-cast joint.



**p/n 13360068**  
**AC TT PMA**  
 Pole mount cap for TTS18, TTS18-A, TTS28 and TTS28-A subwoofer.



**p/n 13360176**  
**AC RD-NET IN-OUT PLUG**  
 RD NET CONTROL BOARD for TTL11A, TT051-A and TT052-A.

# ACCESSORIES



**p/n 13360253  
AC TT1 H-BR**  
TT1-A horizontal U bracket with  
M10-PIN-pole mount



**p/n 13360261  
AC TT2 PLATE**  
2 X TT2-A installation plate



**p/n 13360254  
AC TT1 V-BR**  
TT1-A vertical U bracket with PIN



**p/n 13360262  
AC TT2 END PLATE**  
2 X TT2-A installation end-plate



**p/n 13360244  
AC COVER TT1-A**  
Rain cover for TT1-A



**p/n 13360265  
AC TT5 H-BR**  
TT5-A horizontal U bracket with M10-  
PIN-pole mount



**p/n 13360255  
AC TT1 PLATE**  
2 X TT1-A installation plate



**p/n 13360266  
AC TT5 V-BR**  
TT5-A vertical U bracket with PIN



**p/n 13360256  
AC TT1 END PLATE**  
2 X TT1-A installation end-plate



**p/n 13360259  
AC TT2 H-BR**  
TT2-A horizontal U bracket with M10-  
PIN-pole mount



**p/n 13360260  
AC TT2 V-BR**  
TT2-A vertical U bracket with PIN



**p/n 13360245  
AC COVER TT2-A**  
TT2-A rain cover



**p/n 13360246**  
**AC COVER TT5-A**  
TT5-A rain cover.



**p/n 13360284**  
**AC H-FLY BAR TTP5**  
TTP5-A horizontal fly bar



**p/n 13360267**  
**AC TT5 PLATE**  
2 X TT5-A installation plate.



**p/n 13360268**  
**AC TT5 END PLATE**  
2 X TT5-A installation end-plate



**p/n 13360250**  
**AC COVER TTP5**  
TTP5-A cover



**p/n 13360248**  
**AC WOOD KART TTP5**  
TTP5-A wood kart



**p/n 13360249**  
**AC V-FLY BAR TTP5**  
TTP5-A vertical fly bar



**p/n 13360251**  
**AC H-PLATE TTP5**  
TTP5-A horizontal installation plate



**p/n 13360252**  
**AC H-BUMP TTP5**  
TTP5-A horizontal connecting bar

# TECHNICAL SPECIFICATIONS

## ACTIVE SPEAKERS

### ACOUSTICAL SPEC.

Frequency Response  
Max SPL  
Horizontal coverage angle  
Vertical coverage angle  
Compression Driver  
Midrange  
Woofer

### INPUT SECTION

Input connector  
Output connector  
Input sensitivity

### PROCESSOR SECTION

Crossover frequencies  
Protections  
Limiter  
Controls

### AMPLIFIER

High frequencies  
Mid frequency  
Low frequencies  
Cooling  
Connection

### PHYSICAL SPEC.

Height  
Width  
Depth  
Weight  
Cabinet  
Hardware  
Handles

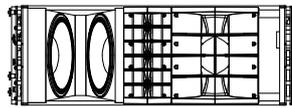

## TTL55-A

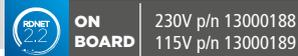

50 Hz - 20 kHz  
143 dB  
90°  
max 7°  
3x1.5" neo, 2.5" v.c.  
10" neo, 3.5" v.c.  
2 x 12" neo, 4" v.c.

xlr, RDNet Ethercon  
xlr, RDNet Ethercon  
4 dBu

320 Hz - 1300 Hz  
thermal, excurs., rms  
soft limiter  
Dsp controlled

500 Watt  
1000 Watt  
2 x 1000 Watt  
convection/forced  
powercon

380 mm (15")  
1020 mm (40")  
550 mm (21.6")  
67 Kg (147.7 lbs)  
baltic birch plywood  
array fly-ware  
2 side

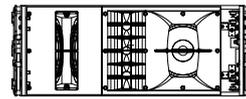

## TTL33-A II



60 Hz - 20 kHz  
135 dB  
100°  
max 15°  
3x1.0" neo, 1.5" v.c.  
8" neo, 2.5" v.c.  
2 x 8" neo, 2.5" v.c.

xlr, RDNet Ethercon  
xlr, RDNet Ethercon  
4 dBu

400 Hz - 1800 Hz  
thermal, hf  
rms, fast limiter  
hf correction, cluster size,  
HPF

250 Watt  
500 Watt  
500 Watt  
convection/forced  
powercon

300 mm (11.8")  
760 mm (30.0")  
450 mm (18.2")  
32.5 Kg (71.5 lbs)  
baltic birch plywood  
array fly-ware  
2 side

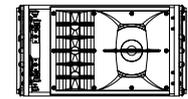

## TTL31-A II

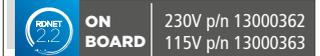

60 Hz - 20 kHz  
132 dB  
100°  
max 15°  
3x1.0" neo, 1.5" v.c.  
-  
8" neo, 2.5" v.c.

xlr, RDNet Ethercon  
xlr, RDNet Ethercon  
4 dBu

1600 Hz  
thermal, hf  
rms, fast limiter  
hf correction, cluster size,  
HPF

250 Watt  
-  
500 Watt  
convection  
powercon

300 mm (11.8")  
538 mm (21.18")  
450 mm (18.2")  
22.5 Kg (49.5 lbs)  
baltic birch plywood  
array fly-ware  
2 side

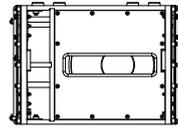
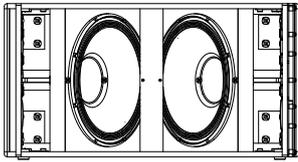

## TTL36-AS

**RDNET 2.2 ON BOARD** 230V & 115 V  
p/n 13000271

35 Hz - 120 kHz  
142 dB  
-  
-  
-  
2 x 18" neo, 4.5" v.c.

xlr, RDNet Ethercon  
xlr, RDNet Ethercon  
-2 dBu / + 10 dBu

80 Hz - 120 Hz  
thermal, excurs., rms  
soft limiter  
Dsp controlled

-  
-  
2 x 2000 Watt  
convection/forced  
powercon

536 mm (21.10")  
1022 mm (40.23")  
970 mm (38.18")  
120 Kg (264.55 lbs)  
baltic birch plywood  
array fly-ware  
6 side

## TTL12-AS

230V p/n 13000124  
115V p/n 13000151

40 Hz - 120 Hz  
131 dB  
-  
-  
-  
12" neo, 4" v.c.

xlr  
xlr  
4 dBu

80/100 Hz  
thermal  
rms, fast limiter  
80/110/add x-over, phase

-  
-  
1000 Watt  
convection  
powercon

390 mm (15.35")  
538 mm (21.18")  
530 mm (20.86")  
37 Kg (81.41 lbs)  
baltic birch plywood  
array fly-ware, pole mount  
2 side

## TTL11A-H

**RDNET 2.2 READY** 230V p/n 13000237  
115V p/n 13000238

150 Hz - 20 kHz  
136 dB  
90°  
10° to 40°  
4 x 1.4" neo, 2.5" v.c.  
3 x 8" neo, 2.5" v.c.  
-

xlr, RDNet Ethercon  
xlr, RDNet Ethercon  
-2 dBu / + 10 dBu

350 Hz - 1300 Hz  
thermal, excurs., rms  
soft limiter  
Dsp controlled

4 x 250 Watt  
3 x 350 Watt  
-  
convection  
powercon

1198 mm (47.16")  
261 mm (10.27")  
242 mm (9.52")  
39 Kg (85.98 lbs)  
baltic birch plywood  
multi-functional  
4 side, top, bottom

## TTL11A-B

**RDNET 2.2 READY** 230V p/n 13000239  
115V p/n 13000240

60 Hz - 300 kHz  
133 dB  
90°  
40°  
-  
-  
4 x 8" neo, 2.5" v.c.

xlr  
xlr  
-2 dBu / + 10 dBu

350 Hz  
thermal, excurs., rms  
soft limiter  
Dsp controlled

-  
-  
2 x 1000 Watt  
convection  
powercon

1198 mm (47.16")  
261 mm (10.27")  
242 mm (9.52")  
37 Kg (81.57 lbs)  
baltic birch plywood  
multi-functional  
4 side, top, bottom

# TECHNICAL SPECIFICATIONS

## ACTIVE SPEAKERS

### ACOUSTICAL SPEC.

Frequency Response  
Max SPL  
Horizontal coverage angle  
Vertical coverage angle  
Compression Driver  
Midrange  
Woofer

### INPUT SECTION

Input connector  
Output connector  
Input sensitivity

### PROCESSOR SECTION

Crossover frequencies  
Protections  
Limiter  
Controls

### AMPLIFIER

High frequencies  
Mid frequency  
Low frequencies  
Cooling  
Connection

### PHYSICAL SPEC.

Height  
Width  
Depth  
Weight  
Cabinet  
Hardware  
Handles

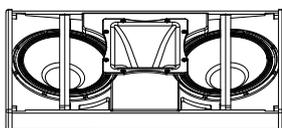

## TT45-SMA

230V p/n 13000192  
115V p/n 13000193

50 Hz - 20 kHz  
136 dB  
90°  
45°  
1.5" neo, 3" v.c.  
-  
2 x 12" neo, 3.5" v.c.

xlr  
xlr  
-2 dBu / + 4 dBu

1400 Hz  
thermal, rms  
soft limiter  
sensitivity, 2 x side eq.

500 Watt  
-  
1000 Watt  
convection  
powercon

380 mm (14.86")  
800 mm (31.5")  
420 mm (16.53")  
38 Kg (83.77 lbs)  
baltic birch plywood  
-  
2 side

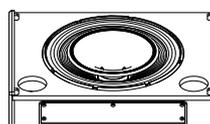

## TT25-SMA

230V p/n 13000118  
115V p/n 13000121

50 Hz - 20 kHz  
131 dB  
60° conical  
60° conical  
1.5" neo, 2.5" v.c.  
-  
15" neo, 3.5" v.c.

xlr  
xlr  
-2 dBu / + 4 dBu

1200 Hz  
thermal, hf  
rms, fast limiter  
side/floor coupling

250 Watt  
-  
500 Watt  
convection  
powercon

330 mm (12.99")  
580 mm (22.83")  
432 mm (17.00")  
20 Kg (44 lbs)  
baltic birch plywood  
-  
2 side

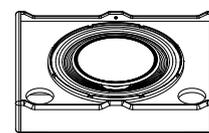

## TT25-CXA

 **ON BOARD** 230V p/n 13000448  
115V p/n 13000449

50 Hz - 20 Hz  
133 dB  
60°  
60°  
1.5" neo, 2.5" v.c.  
-  
15" neo, 3.5" v.c.

xlr, RDNet on-board  
xlr, RDNet on-board  
+ 4 dBu

900 Hz  
thermal, HF  
soft limiter, dynamic proces.  
8 selectable presets

1100 Watt  
300 Watt  
800 Watt  
convection  
Powercon in-out

352,9 mm (13.89")  
580 mm (22.83")  
486,5 mm (19.15")  
18.0 Kg (39.6 lbs)  
Polyurea coated Baltic birch  
pole mount  
1 top

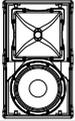

### TT1-A

**RDNET 2.2** **READY** 230V p/n 13000377  
115V p/n 13000381

55 Hz - 20 kHz  
131 dB  
90°  
60°  
2" neo, 3.0" v.c.  
-  
10" neo, 3.0" v.c.

xlr, RDNet ready  
xlr, RDNet ready  
+ 4 dBu

900 Hz  
thermal, rms  
soft limiter, dynamic proces.

Gain reduction, RDNet local setup/bypass, Time Delay, Presets (Linear, Close, Far listening, High-pass), RDNet Ready

800 Watt  
250 Watt  
550 Watt  
convection  
Powercon in-out

566 mm (22.28")  
333 mm (13.11")  
370 mm (14.56")  
25.4 Kg (55.99 lbs)  
baltic birch plywood  
Instal./rental fittings  
2 side

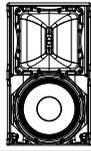

### TT2-A

**RDNET 2.2** **READY** 230V p/n 13000378  
115V p/n 13000382

50 Hz - 20 kHz  
134 dB  
90°  
50°  
2" neo, 3.0" v.c.  
-  
12" neo, 4.0" v.c.

xlr, RDNet ready  
xlr, RDNet ready  
+ 4 dBu

750 Hz  
thermal, rms  
soft limiter, dynamic proces.

1600 Watt  
500 Watt  
1100 Watt  
convection  
Powercon in-out

643 mm (25.31")  
372 mm (14.64")  
470 mm (18.50")  
34.0 Kg (74.95 lbs)  
baltic birch plywood  
Instal./rental fittings  
2 side

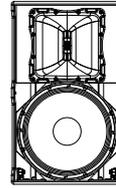

### TT5-A

**RDNET 2.2** **READY** 230V p/n 13000379  
115V p/n 13000383

45 Hz - 20 Hz  
136 dB  
90°  
50°  
2" neo, 4.0" v.c.  
-  
15" neo, 4.0" v.c.

xlr, RDNet ready  
xlr, RDNet ready  
+ 4 dBu

650 Hz  
thermal, rms  
soft limiter, dynamic proces.

1600 Watt  
500 Watt  
1100 Watt  
convection  
Powercon in-out

735 mm (28.94")  
443.8 mm (17.47")  
529 mm (20.82")  
42.0 Kg (92.59 lbs)  
baltic birch plywood  
Instal./rental fittings  
2 side

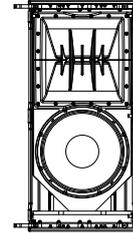

### TTP5-A

**RDNET 2.2** **ON BOARD** 230V p/n 13000380  
115V p/n 13000384

45 Hz - 20 kHz  
138 dB  
22.5°  
60°  
2" neo, 4.0" v.c.  
-  
15" neo, 4.0" v.c.

xlr, RDNet On Board  
xlr, RDNet On Board  
+ 4 dBu

550 Hz  
thermal, rms  
soft lim., dynamic proces.

Gain reduction, RDNet local setup/bypass, Time Delay, Presets, RDNet On Board

1600 Watt  
500 Watt  
1100 Watt  
convection  
Powercon in-out

986 mm (38.81")  
458 mm (18.03")  
646 mm (25.43")  
66.0 Kg (145.50 lbs)  
baltic birch plywood  
Cluster mechanics  
2 side, 1 top, 1 bottom

# TECHNICAL SPECIFICATIONS

## ACTIVE SPEAKERS

### ACOUSTICAL SPEC.

Frequency Response  
Max SPL  
Horizontal coverage angle  
Vertical coverage angle  
Compression Driver  
Midrange  
Woofer

### INPUT SECTION

Input connector  
Output connector  
Input sensitivity

### PROCESSOR SECTION

Crossover frequencies  
Protections  
Limiter  
Controls

### AMPLIFIER

High frequencies  
Mid frequency  
Low frequencies  
Cooling  
Connection

### PHYSICAL SPEC.

Height  
Width  
Depth  
Weight  
Cabinet  
Hardware  
Handles

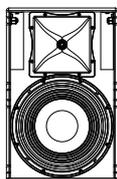

## TT25-A II

**RDNET 2.2 ON BOARD** 230V p/n 13000446  
115V p/n 13000447

50 Hz - 20 kHz  
134 dB  
90°  
60°  
1.5" neo, 4.0" v.c.  
-  
15" neo, 3.5" v.c.

xlr, RDNet on-board  
xlr, RDNet on-board  
+ 4 dBu

750 Hz  
thermal, HF  
fast limiter, dynamic proces.  
8 selectable presets

1100 Watt  
300 Watt  
800 Watt  
convection  
Powercon in-out

670 mm (26.38")  
425 mm (16.73")  
425 mm (16.73")  
26.0 Kg (57.3 lbs)  
Polyurea coated Baltic birch  
6Fly tracks,q.lock,p.mount  
2 side

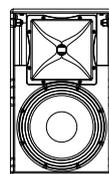

## TT22-A II

**RDNET 2.2 ON BOARD** 230V p/n 13000444  
115V p/n 13000445

50 Hz - 20 kHz  
133 dB  
90°  
60°  
1.5" neo, 3.0" v.c.  
-  
12" neo, 3.5" v.c.

xlr, RDNet on-board  
xlr, RDNet on-board  
+ 4 dBu

800 Hz  
thermal, HF  
fast limiter, dynamic proces.  
8 selectable presets

1100 Watt  
300 Watt  
800 Watt  
convection  
Powercon in-out

600 mm (23.62")  
365 mm (14.37")  
379 mm (14.92")  
18.5 Kg (40.7 lbs)  
Polyurea coated Baltic birch  
6Fly tracks,q.lock,p.mount  
2 side



## TT052-A

**RDNET 2.2 READY** 230V p/n 13000245  
115V p/n 13000246

65 Hz - 20 kHz  
123 dB  
Conical 90°  
Conical 90°  
1 x 1" neo, 1.5" v.c.  
-  
2 x 5" woofer, 1.2" v.c.

xlr, RDNet ready  
xlr  
-2 dBu / + 10 dBu

1500 Hz  
thermal, excurs., rms  
soft limiter  
Dsp controlled

150 Watt  
-  
150 Watt  
convection  
powercon

493 mm (19.40")  
150 mm (5.90")  
190 mm (7.48")  
7.2 Kg (15.87 lbs)  
baltic birch plywood  
multi-functional  
Top, bottom

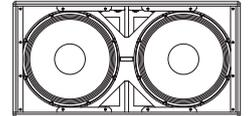
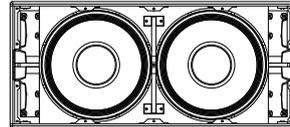
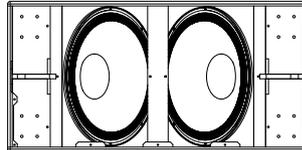
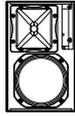

## TT051-A

**RDNET 2.2** READY | 230V p/n 13000243  
115V p/n 13000244

65 Hz - 20 kHz  
116 dB  
Conical 110°  
Conical 110°  
1 x 1" metal tweeter  
-  
1 x 5" woofer, 1.2" v.c.

xlr, RDNet ready  
xlr  
-2 dBu / + 10 dBu

1800 Hz  
thermal, excurs., rms  
soft limiter  
Dsp controlled

150 Watt  
-

150 Watt  
convection  
powercon

348 mm (13.70")  
150 mm (5.90")  
190 mm (7.48")  
4.5 Kg (9.92 lbs)  
baltic birch plywood  
multi-functional  
Top, bottom

## TT08-A

230V p/n 13000116  
115V p/n 13000120

65 Hz - 20 kHz  
128 dB  
90°  
60°  
1" neo, 1.5" v.c.  
-  
8" neo, 2.5" v.c.

xlr  
xlr  
-2 dBu / + 4 dBu

1700 Hz  
thermal, hf  
rms, soft limiter  
side/floor coupling

250 Watt  
-

500 Watt  
convection  
powercon

430 mm (16.93")  
270 mm (10.63")  
303 mm (11.93")  
11.4 Kg (25.13 lbs)  
baltic birch plywood  
2Fly tracks, p.mount  
-

## TTS56-A

**RDNET 2.2** ON BOARD | 230V & 115 V  
p/n 13000190

30 Hz - 100 Hz  
145 dB  
-  
-  
-  
-  
2 x 21" neo, 4.5" v.c.

xlr, RDNet Ethercon  
xlr, RDNet Ethercon  
-2 dBu / + 10 dBu

60 Hz - 80 Hz  
thermal, excurs., rms  
soft limiter  
Dsp controlled

-  
-  
2 x 3400 Watt  
convection/forced  
powercon

590 mm (23.22")  
1170 mm (46.06")  
988 mm (38.89")  
115 Kg (253.5 lbs)  
baltic birch plywood  
Steel bars x fork-lift, 4wheels  
6 side

## TTS36-A

**RDNET 2.2** ON BOARD | 230V & 115 V  
p/n 13000272

35 Hz - 120 Hz  
143 dB  
-  
-  
-  
-  
2 x 18" neo, 4.5" v.c.

xlr, RDNet Ethercon  
xlr, RDNet Ethercon  
-2 dBu / + 10 dBu

80 Hz - 120 Hz  
thermal, excurs., rms  
soft limiter  
Dsp controlled

-  
-  
2 x 2000 Watt  
convection/forced  
powercon

525 mm (20.66")  
1170 mm (46.06")  
850 mm (33.46")  
95 Kg (209.4 lbs)  
baltic birch plywood  
Steel bars x fork-lift, 4wheels  
6 side

## TTS26-A

**RDNET 2.2** ON BOARD | 230V & 115 V  
p/n 13000241

35 Hz - 120 Hz  
140 dB  
-  
-  
-  
-  
2 x 15" neo, 4" v.c.

xlr, RDNet Ethercon  
xlr, RDNet Ethercon  
-2 dBu / + 10 dBu

90 Hz - 120 Hz  
thermal, excurs., rms  
soft limiter  
Dsp controlled

-  
-  
3400 Watt  
convection/forced  
powercon

460 mm (18.11")  
900 mm (35.43")  
700 mm (27.55")  
73 Kg (160.93 lbs)  
baltic birch plywood  
TTL11A ready, 4 wheels  
4 side

# TECHNICAL SPECIFICATIONS

## WP SPEAKERS

### SYSTEM

Frequency Range (-10 dB)  
 Horizontal coverage angle  
 Vertical coverage angle  
 System sensitivity  
 Rated maximum SPL  
 System nominal impedance  
 System input power rating AES  
 System input power rating PEAK  
 Recommended amplifier  
 HF protection  
 Crossover

### TRANSDUCERS

Low frequency  
 Nominal impedance  
 Input power rating  
 Sensitivity

Mid frequencies  
 Nominal impedance  
 Input power rating  
 Sensitivity

High frequencies  
 Nominal impedance  
 Input power rating  
 Sensitivity

### PHYSICAL SPEC.

Height  
 Width  
 Depth  
 Weight  
 Cabinet  
 Hardware  
 Handles

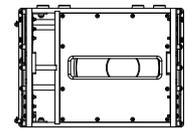
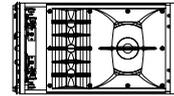
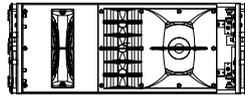

## TTL33 WP

p/n 13000248

50 Hz - 20 kHz  
 100°  
 15°  
 100 dB. 1W @ 1m  
 133 dB. 1W @ 1m  
 8 Ohm  
 1000 Watt  
 4000 Watt  
 2000 Watt  
 dynamic mosfet  
 500 Hz

2x8", 2.5" v.c.  
 8 Ohm  
 600 Watt AES  
 95 dB. 1W @ 1m

8", 2.5" v.c.  
 8 Ohm  
 250 Watt AES  
 98 dB. 1W @ 1m

3x1", 1.4" v.c.  
 8 Ohm  
 75 Watt AES  
 109 dB. 1W @ 1m

300 mm (11.8")  
 760 mm (30.0")  
 450 mm (18.2")  
 29.2 Kg (64.2 lbs)  
 baltic birch plywood  
 array fittings  
 2 side

## TTL31 WP

p/n 13000250

60 Hz - 20 kHz  
 100°  
 15°  
 100 dB. 1W @ 1m  
 128 dB. 1W @ 1m  
 8 Ohm  
 300 Watt  
 1200 Watt  
 600 Watt  
 dynamic mosfet

8", 2.5" v.c.  
 8 Ohm  
 300 Watt AES  
 95 dB. 1W @ 1m

-  
 -  
 -  
 -

3x1", 1.4" v.c.  
 8 Ohm  
 75 Watt AES  
 109 dB. 1W @ 1m

300 mm (11.8")  
 538 mm (21.1")  
 450 mm (18.2")  
 19.2 Kg (42.2 lbs)  
 baltic birch plywood  
 array fittings  
 2 side

## TTL12-S WP

p/n 13000253

55 Hz - 200 Hz  
 -  
 -  
 94 dB. 1W @ 1m  
 124 dB. 1W @ 1m  
 8 Ohm  
 700 Watt  
 2800 Watt  
 1400 Watt

12", 4" v.c.  
 8 Ohm  
 300 Watt AES  
 95 dB. 1W @ 1m

-  
 -  
 -  
 -

-  
 -  
 -  
 -

700 mm (27.55")  
 700 mm (27.55")  
 920 mm (36.22")  
 35.8 Kg (78.7 lbs)  
 baltic birch plywood  
 array fittings  
 2 side

## WP SPEAKERS

### SYSTEM

Frequency Range (-10 dB)  
Horizontal coverage angle  
Vertical coverage angle  
System sensitivity  
Rated maximum SPL  
System nominal impedance  
System input power rating AES  
System input power rating PEAK  
Recommended amplifier  
HF protection  
Crossover

### TRANSDUCERS

Low frequency  
Nominal impedance  
Input power rating  
Sensitivity

High frequencies  
Nominal impedance  
Input power rating  
Sensitivity

### PHYSICAL SPEC.

Height  
Width  
Depth  
Weight  
Cabinet  
Hardware  
Handles

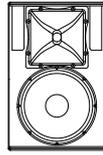

## TT22 WP

p/n 13000252

50 Hz - 20 kHz  
90°  
60°  
98 dB. 1W @ 1m  
131 dB. 1W @ 1m  
8 Ohm  
800 Watt  
3200 Watt  
1600 Watt  
Active mosfet  
1.3 kHz

12" , 4" v.c.  
8 Ohm  
700 Watt AES  
98 dB. 1W @ 1m

1.5" , 3" v.c.  
8 Ohm  
100 Watt AES  
111 dB. 1W @ 1m

600 mm (23.62")  
400 mm (15.74")  
400 mm (15.74")  
28.8 Kg (63.49 lbs)  
baltic birch plywood  
6 x fly tracks, pole mount  
2 side

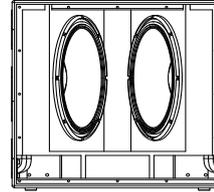

## TTS28 WP

p/n 13000251

30 Hz - 110 Hz  
-  
-  
100 dB. 1W @ 1m  
139 dB. 1W @ 1m  
4 Ohm  
2000 Watt  
8000 Watt  
3000 Watt  
-  
-

2 x 18" , 4" v.c.  
8 Ohm  
2400 Watt AES  
99 dB. 1W @ 1m

-  
-  
-  
-

700 mm (27.56")  
700 mm (27.56")  
920 mm (36.22")  
73 Kg (160.93 lbs)  
baltic birch plywood  
fittings ready  
6 side



sound culture

HEADQUARTERS:

RCF S.p.A. Italy  
tel. +39 0522 274 411  
e-mail: info@rcf.it

RCF UK  
tel. 0844 745 1234  
Int. +44 870 626 3142  
e-mail: info@rcfaudio.co.uk

RCF France  
tel. +33 1 49 01 02 31  
e-mail: france@rcf.it

RCF Germany  
tel. +49 2203 925370  
e-mail: germany@rcf.it

RCF Spain  
tel. +34 91 817 42 66  
e-mail: info@rcfaudio.es

RCF Benelux  
tel. +49 (0) 2203 9253724  
e-mail: benelux@rcf.it

RCF USA Inc.  
tel. +1 732-9026100  
e-mail: info@rcf-usa.com

[www.rcf.it](http://www.rcf.it)